

NICO J. VAN STRIEN

THE SUMATRAN RHINOCEROS
- *Dicerorhinus sumatrensis* (Fischer, 1814) -
IN THE GUNUNG LEUSER NATIONAL PARK,
SUMATRA, INDONESIA;
ITS DISTRIBUTION, ECOLOGY AND CONSERVATION.



Promotor: dr. C.W. Stortenbeker,
hoogleraar natuurshoud en -beheer

NICO J. VAN STRIEN

THE SUMATRAN RHINOCEROS
- *Dicerorhinus sumatrensis* (Fischer, 1814) -
IN THE GUNUNG LEUSER NATIONAL PARK,
SUMATRA, INDONESIA;
ITS DISTRIBUTION, ECOLOGY AND CONSERVATION.

Proefschrift
ter verkrijging van de graad van
doctor in de landbouwwetenschappen,
op gezag van de rector magnificus,
dr. C.C. Oosterlee,
in het openbaar te verdedigen,
op vrijdag 21 juni 1985
des namiddags te vier uur in de aula
van de Landbouwhogeschool te Wageningen.

Privately published, Doorn, 1985

© 1985, Nico J. van Strien

BIBLIOTHEEK
DER
LANDBOUWUNIVERSITEIT
WAGENINGEN

STELLINGEN

1- De veelgehoorde opvatting dat de Sumatraanse neushoorn door verstoring vanuit het laagland naar de bergen zou zijn gedreven is onjuist.

2- Laurie's veronderstelling dat bij de vrouwelijke Sumatraanse neushoorn de oestrus lang op zich laat wachten en dat het mannetje het wijfje gedurende een tamelijk lange periode voor de oestrus begeleidt, dit om competitie tussen mannetjes te bevorderen, wordt tegengesproken door de resultaten van dit onderzoek.

Ref: Laurie, A.W., 1973. The ecology and behaviour of the greater one-horned rhinoceros. Thesis University of Cambridge.

3- Het relatief snelle uitsengaan van de moeder en haar kalf is een aanpassing van de Sumatraanse neushoorn aan het leven in het tropische bos.

4- Börner's schatting van het totale aantal neushoorns in Gunung Leuser -20 tot 40- is niet in overeenstemming met de gegevens die hij heeft verkregen in zijn studie gebied.

Ref: Börner, M., 1979. A field study of the Sumatran rhinoceros, *Dicerorhinus sumatrensis* Fischer 1814; ecology and behaviour conservation situation in Sumatra. Zurich, Juris. Thesis University of Basel.

5- Het bestuderen van voetsporen is een waardevol hulpmiddel bij onderzoek aan grote zoogdieren in het tropische bos, maar om bruikbare gegevens op te leveren dient dit nauwkeuriger te geschieden dan in het verleden gebruikelijk was.

6- De regel in de zoologische nomenclatuur dat de spelling van de uitgang van soortsnamen afgeleid van Latijnse bijvoeglijke naamwoorden, grammaticaal in overeenstemming moet zijn of moet worden gebracht met het geslacht van de genusnaam waarmee hij wordt geassocieerd, dient geen enkel wetenschappelijk doel en schiept verwarring, en is als zodanig strijdig met de doelstelling van uniformiteit en stabiliteit in de zoologische nomenclatuur, uitgedrukt in de preambule van de International Code of Zoological Nomenclature.

7- Bij het vaststellen van beheersmaatregelen betreffende diersoorten in de tropische bosgebieden, is het verstandig er rekening mee te houden dat de in de relevante literatuur vermelde aantallen en dichtheden van deze soorten in veel gevallen een zeer ruime onderschatting zijn van de werkelijke getallen.

8- De bijdrage die Nederland kan geven aan de discussie over het wereldbevolkingsvraagstuk zou aanmerkelijk waardevoller en zinvoller worden als daarbij de extreme bevolkingsdruk en daarmee gepaard gaande uitputting van de natuurlijke hulpbronnen in het eigen land zouden worden betrokken.

Ref: Kouwen, J., 1984. Minister Schoot aandacht voor vrouwen en milieu in het kader van bevolkingsbeleid. Internationale Samenwerking 14, 7.

9- Voor de bescherming op de lange termijn van de Australische kangoeroe is het beter de handel in kangoeroevlees en -huiden te stimuleren dan te proberen deze te beperken of te stoppen.

Ref: Daly, T. & A. Pickaver, 1984. Kangoeroe zit te springen om bescherming. *Greenpeace* 6(2), 7.

10- Door de uitdrukkelijke stellingname in de World Conservation Strategy dat 'conservation' een activiteit is met het doel de mens te dienen, kan dit document niet gezien worden als een nuttige bijdrage aan het streven natuurlijke levensgemeenschappen en niet-menselijke levensvormen te behouden.

11- Er dient in Nederland niet alleen aandacht te worden besteed aan een betere verdeling van de beschikbare werkgelegenheid, maar vooral ook aan een betere verdeling van de werkloosheid.

behorende bij: Nico J. van Strien. The Sumatran rhinoceros - *Dicerorhinus sumatrensis* (Fischer, 1814) - in the Gunung Leuser National Park, Sumatra, Indonesia; its distribution, ecology and conservation.

CONTENTS

1	-	INTRODUCTION	1
1.1		Aims of the study	1
1.2		Initiation of the study	4
1.3		Execution of the programme	4
1.4		Previous research	5
2	-	THE STUDY AREA AND GENERAL METHODS	7
2.1		Selection and establishment of the study area	7
2.2		Organization of the expeditions	8
2.3		Description of the study area	9
2.3.1		The Gunung Leuser National Park	9
2.3.2		Physiography of the study area	9
2.3.3		Climate and weather in the study area	13
2.3.4		Plant cover of the study area	15
2.3.5		The other mammal fauna	16
2.4		The patrolling system	18
3	-	THE STUDY OF THE RHINO'S TRACKS	19
3.1		Morphology of the rhino's foot	19
3.2		The art of plastercast making	24
3.2.1		Finding the tracks	25
3.2.2		Selection of the prints	25
3.2.3		Preparation of the selected prints	26
3.2.4		The casting	26
3.2.5		Preservation of the casts	27
3.3		Aids for comparison of the casts	27
3.3.1		The stereophotographs	28
3.3.2		The outline drawings	28
3.3.3		The standard measurements	28
3.4		Procedure of the sorting and identification of the casts	31
3.5		Characteristics and variability shown in the casts	34
3.5.1		General characteristics	34
3.5.2		Influence of the soil	35
3.5.3		Influence of the type of movement	43
3.5.4		Gradual changes in size and shape	48
3.6		An illustrative example	57
3.6.1		Formation of an exemplary series	57
3.6.2		Comparison with other series	58
3.7		Final results of the plastercast identification	73
3.8		Evaluation of the method of plastercast analysis	73
3.9		Recommendations for future use	75
4	-	GROWTH AND AGING	76
4.1		Growth of the foot of the calf	76
4.2		Age classes	81
4.3		Sex classes and sexual differentiation in footprint	82
5	-	DISTRIBUTION AND DENSITY	84
5.1		Distribution of the age and sex classes	84
5.1.1		Distribution of the females and their calves	84
5.1.2		Distribution of the sub-adults	90
5.1.3		Distribution of the males and other adults	90
5.1.4		The overall distribution pattern	92

5.2	Analysis of the individual ranges	97
5.2.1	Female home ranges	97
5.2.2	Home range of the calves after weaning	99
5.2.3	Home range of the other sub-adults	99
5.2.4	Male home range	100
5.3	Density of the rhino in the study area	105
5.3.1	Density calculations based on distribution	105
5.3.2	Density calculated from the number of individuals per expedition	107
5.3.3	Density calculated from the number of direct observations	108
5.4	Comparative occurrence in parts of the area	110
5.4.1	Counts of fresh tracks	110
5.4.2	Frequency of use of the game trails	111
5.4.3	Comparison of different areas	113
5.5	Other methods to record the use of the trails	114
5.6	Frequency of visits to the saltlicks	114
6	- THE LIFE CYCLE	116
6.1	The sex ratio of the population	116
6.2	The mating system	116
6.3	Birth of the young	117
6.4	The breeding interval	118
6.5	Development of the calf	119
6.6	The sub-adult phase	119
7	- DAILY ACTIVITIES OF THE RHINO	121
7.1	The system of trails	121
7.2	The daily movements	122
7.3	Wallows and wallowing	125
7.3.1	Location and form of the wallows	125
7.3.2	Pattern of use of the wallows	127
7.4	Marks and marking behaviour	127
7.5	Faeces and defaecation	129
7.6	Urine and urination	132
8	- FEEDING AND THE MINERAL BALANCE	133
8.1	The food	133
8.2	Availability of food	134
8.3	The mineral balance	135
8.3.1	Mineral contents of the foodplants	135
8.3.2	Mineral contents of the saltlicks	137
9	- SUMMARY AND EVALUATION OF RESULTS	139
10	- RECOMMENDATIONS FOR FUTURE STUDIES	142
10.1	Plastercast in comparison to print measurements	142
10.2	Usefulness of different measurements for censusing rhino populations	147
10.3	Track counts for estimating rhino density	151
10.4	Censusing rhino	152
10.5	Recommendations for further ecological study	153
11	- CONSERVATION OF THE SUMATRAN RHINO	154
11.1	The chances for survival	154
11.2	Design and management of rhino reserves	156
11.3	A strategy for survival of the Sumatran rhino	157

APPENDIX A: Hoofs of Sumatran rhino	159
APPENDIX B: Present status of the Sumatran rhino	167
B.1 The situation in Sumatra	167
B.2 The situation in Borneo	171
B.3 The situation in Malaysia	172
B.4 The situation in other countries	172
B.5 Summary of the present status of the Sumatran rhino	173
APPENDIX C: Rhino poaching in the Gunung Leuser reserve	175
ACKNOWLEDGEMENTS	178
REFERENCES	179
PLATES	183

CHAPTER 1 - INTRODUCTION

1.1 - Aims of the study.

At present the world is seeing an exponential increase in numbers, together with a rapid increase in the per capita usage of matter and energy, of several taxa in the genus *Homo*, modern man. The taxa that show this technology-induced population explosion, rapidly increase the land area they occupy and the share of the world's primary production that they consume, at the expense of other species and races that cannot cope with this pressure on space and natural resources. The most notable victims of this development are other human taxa, those that do not share in the technology which increases individual survival rates, together with an ever increasing number of other non-human creatures.

Increasingly a great number of species, that once occupied large tracts of the world, are being driven out of their usual haunts by human invaders and survive only in very small numbers in isolated and often less attractive areas. Several species have already lost their last strongholds and have disappeared, many are vulnerable or endangered, while only a few can thrive in the environments created by technology-using man, who now controls most of the world's surface.

But a small section of the human population has realized that man's increasing reliance on technology and manipulation of his environment may lead to catastrophe, threatening not only a large part of the existing forms of life, but also endangering the continued existence and development of human kind and of the whole complex of life on this planet. Conservationists try to stress the environmental impact of technological developments and promote measures to alleviate their influence. One of the more successful concepts promoted by the conservation movement is the creation of nature reserves, land areas set aside by their governing bodies to protect the natural habitat and its natural ecosystems. In these areas a variety of life forms that have survived so far will have a chance for continued existence until we achieve a more balanced sharing of space and resources with coexistence of a multiplicity of creatures, human and non-human.

Throughout the world reserves are created for this purpose and, with varying success, managed by the competent organisations in a way that will give the biota protection against being eliminated by uncontrolled human invasion. But although these reserved or restricted areas nowhere occupy more than a tiny part of the area to which the human population claims exclusive rights, it is becoming more and more difficult to honour the pledge to leave them in a largely natural state. In large parts of the world the human population has increased its numbers and consumption to, or beyond, the sustainable level increasing the pressure on those few untapped resources and unsettled lands that remain.

Unless human population growth is curbed drastically, the space and resources available for the other animal species on this planet will diminish further, leaving ever smaller populations in more and more isolated areas. The first creatures to suffer are the large land animals, who need relatively large areas for their natural way of life. Several have already disappeared and many more are now surviving only in small remnant populations, often in marginal habitats.

Large areas of natural habitat, where animals and plants can survive in natural balance, will become rarer and rarer, and in many parts of the world such areas no longer exist. Conservation will have to deal more and more with populations of animals and plants that are in themselves so small, or confined to such an inadequate environment, that their long-term survival is unlikely.

Conservationists will have to continue and ever increase their efforts in the years ahead. Much can be done by protection of adequate samples of the world's ecosystems in nature reserves, but some species will need additional aid if they are not to become extinct. Some will be difficult to contain in a restricted area; others may be subject to specific threats, even in protected areas. The Sumatran rhinoceros (*Dicerorhinus sumatrensis* (Fischer, 1814)) appears to be one of those animals for which the protection of its habitat alone is not sufficient.

The Sumatran rhino is now one of the rarest and most threatened mammals, not only because of the disappearance of a large part of its habitat, but more so because of the age-long persecution for its horn and other marketable parts, that fetch high prices in several parts of Asia. This trade has caused the rhino to disappear from most of the remaining rainforest areas in its former distribution. The precarious situation of this species is well illustrated in figure 1.1, showing the known historical and present distributions. Once the animal occurred in mountainous regions from Sumatra and Borneo to the foothills of the Himalayas in Bhutan, now it is only found in small numbers at a few remote and isolated locations. Even if adequate samples of habitat can be preserved, additional measures will be necessary to protect the rhinos inside the reserve from poachers.

The Sumatran rhino is of special interest because it is the largest mammal dependant on undisturbed rainforest and as such it can be regarded as an important indicator species. Its presence indicates that the area is relatively very little disturbed and in the design of reserves meant to preserve the whole Southeast Asian fauna the habitat requirements and population structure of the Sumatran rhino should be one of the major considerations. Size and shape of the reserves should be such that they give maximum protection to a sufficient number of those species which need a large home range, have a low density and are most susceptible to disturbance in any form, and the Sumatran rhino is a typical example of such an animal.

In general one can state that a reserve that suits the needs of the Sumatran rhino and where the management can protect it against poaching, will also suffice for the smaller species that utilise the same habitat. The preservation of the Southeast Asian rainforests is closely linked to the well-being of the Sumatran rhino. Although the habits of the Sumatran rhino are poorly known, this study was initiated not only for academic interest but to test the notion that management practices can only be effective if they take into account the biology of the species they are supposed to protect. The Gunung Leuser National Park was chosen as a study site because it was the only area known at that time to harbour more than a few scattered rhinos and because there was a good basis for research there in the form of existing facilities and available literature and expertise.

The Sumatran rhinoceros was, and still is, one of the least studied and least known mammals, because of its elusive character, its rarity and the inhospitable nature of its habitat. Prior to this study very little was known about the distribution, the general life-history and habitat requirements of this species, and the available data were mainly based on fortuitous observations (van Strien, 1974). It was a major aim of this study to collect long-term systematic data which would help us to evolve a strategy to protect this species in Gunung Leuser and elsewhere.

Primarily information on distribution and numbers, habitat requirements, diet, reproduction, behaviour and social organisation were needed, but because the proposed study area was virtually unexplored and very little was known about the nature and extent of the rhino population, the study programme had to be kept very general and unspecific. In fact every aspect of the rhino's way of life was open for study, but we were limited in our observations by the difficult terrain and by luck in encountering animals. During surveys additional information on other larger mammals was also collected.

The first priority was to find and develop a study area that was accessible yet free from human disturbance. This involved penetrating the unexplored interior of the reserve, where rhino hunters and other people had not previously been. This had to be done without endangering the few surviving rhinos. The study area also needed to be large enough to overlap the ranges of a number of rhinos and cover as much as possible of the ecological variation in the rhino's habitat.

Previous field research on the Sumatran rhino had shown that direct observation of the animal is almost impossible in the dense tropical forests and the study of indirect evidence is often the only feasible procedure (Strickland, 1967; Kurt, 1970; Borner, 1973, 1974). Tracks and footprints are the most obvious signs of the rhino's passing, and it is impossible to attempt a field study of these animals without concentrating mainly on their tracks. Previous research programmes have attempted to identify individual rhinos on the size of their footprints, but the results were not very satisfactory, because the methods were too crude to identify more than a few individuals with certainty. Therefore one of the main aims of this study was to develop better ways to study the rhino's tracks, so that individual rhinos could be identified from their tracks.

Once the rhinos could be identified with reasonable certainty in this way, their movements could be followed in space and time and patterns of distribution and density could be established. Eventually it should be possible to determine age and sex classes which would give insight into the social structure of the population. Where young accompanying a female could be identified information on the breeding system could be collected. Moreover mapping of the individual tracks would reveal some of the daily activities of the rhino. Without a good technique for recognition of individual rhinos however, the study would not be able to provide much new or useful information. Therefore much attention was given to the development of a technique, involving plastercasts of rhino tracks, and the majority of the data presented in this study is directly or indirectly based on the analysis of the rhinos' footprints.

Dicerorhinus sumatrensis - Sumatran rhinoceros

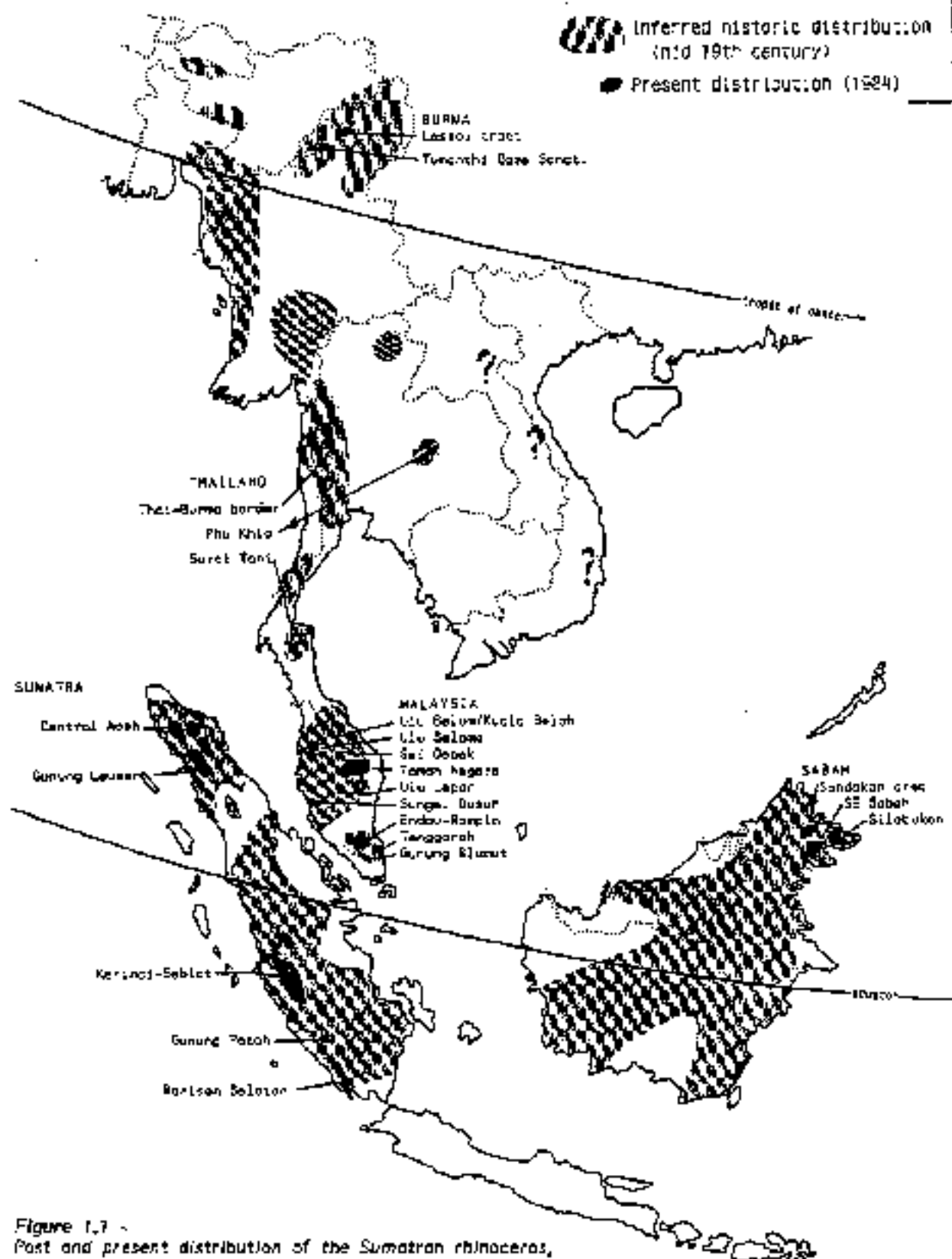

Figure 1.7 -

Past and present distribution of the Sumatran rhinoceros, based on records in the literature.

Sources - Historic distribution: van Strien, 1974; Roopmaaker, 1977; Roopmaaker, 1980.

(The occurrence in the Indochinese region is doubtful)

Present distribution: Recent reports and personal information. See appendix B.

Radio-tagging of Sumatran rhino was not considered for several reasons. Firstly, the risks of injury or loss of animals during darting and immobilisation were considered to be unacceptable for a species that is in such a perilous position. Also the setting up and manning of a capture operation would cause considerable disturbance in the rhino area. Secondly, it was felt, certainly in the later stages of the study when the first results of the track analysis were available, that radio-tagging would not give more or better results. Moreover with track analysis the distribution of all rhinos in the area can be studied simultaneously, while with radio-tagging only a few, if any, can be followed, usually for a limited period. Thirdly, the use of radio-tags requires regular hire of aircraft, which would have increased the costs enormously.

1.2 - Initiation of the study

At the 10th General Assembly (1969, New Delhi) of the International Union for Conservation of Nature and Natural Resources (IUCN), the Indonesian delegation invited the World Wildlife Fund (WWF) and IUCN to carry out a preliminary investigation in the Gunung Leuser Nature Reserve in northern Sumatra, aimed at collecting basic ecological data on the fauna and the main threats to the reserve, and formulating future management practices and a research programme. This preliminary survey was carried out in 1970 by Dr. Fred Kurt, then lecturer at Zurich University, and Mr. Walman Sinaga, current head of the Indonesian Nature Conservation and Wildlife Management Division.

One of the recommendations of the survey was to include ecological studies of the Sumatran rhinoceros and other animals. This recommendation was followed by a proposal in August 1972 to IUCN/WWF, accepted under no 889/1972 C/1/55,1- Sumatran Rhinoceros International Conservation Programme, for a long term rhinoceros research project in the Gunung Leuser Reserve. This project consisted of two parts, an extensive programme, to investigate the distribution of the rhino over the whole of Sumatra, and a more intensive and detailed study of the animal's ecology in the core-area of its distribution in Gunung Leuser.

The intensive programme was implemented as a cooperative venture between IUCN/WWF, undertaken by the Gunung Leuser Committee and the Nature Conservation Department of the Agricultural University of Wageningen, then under the direction of Prof. Dr. M.F. Mörzer Bruns. Funds were applied for from various sources and the author was requested to carry out the field work for a doctoral dissertation.

Because of scepticism with regard to the feasibility of a field study of an animal that was notably rare and shy and that was almost impossible to observe, it was difficult to find sufficient funds. Only in 1974, after several organizations, companies and persons had expressed their confidence by donating small sums for the project (see the acknowledgements), a research grant was obtained from the Netherlands Foundation for the Advancement of Tropical Research (WOTRO), and a fellowship at the Department of Nature Conservation was granted from the Agricultural University of Wageningen, the Netherlands.

The extensive part of the project, a broader survey to determine the distribution of the rhino in Sumatra was conducted by a Swiss zoologist, Marcus Börner, funded by WWF. He worked from 1972 till 1975 in Sumatra and published his results in a thesis in 1979: A field Study of the Sumatran Rhinoceros, *Dicerorhinus sumatrensis* Fisher, 1814, Ecology and Behaviour Conservation Situation in Sumatra. Juris, Zurich.

1.3 - Execution of the programme

After arrival in Sumatra in December 1974, I made three preliminary expeditions into the interior of the reserve with a botanical survey under the guidance of Dr. W. J. J. O. de Wilde and Dr. B. E. B. de Wilde - Duyffes from the National Herbarium at Leiden, the Netherlands. During these trips we visited some of the highest mountains in the reserve (Gunung (=mount) Bandahara, Gunung Leuser, and Gunung Mamas) and I gained much valuable experience in travelling, living and working in the Sumatran mountain forests.

In July 1975 I made my first rhino expedition to the area that had been selected for the study, the upper Mamas valley. This area was found to be suitable, because it is relatively undisturbed rhino habitat, and over the next four years 16 more expeditions were made to this area. Until December 1977 work on the study was basically full time, although considerable time was spent on other activities related to the management of the reserve and WWF's activities there. From January 1978 till August 1979 the study was continued on a part time basis while the author was employed by WWF for the drafting and implementation of a management plan for the Gunung Leuser National Park. After that date the author was appointed lecturer of biology at the School of Environmental Conservation Management of Clawi, Indonesia, but was able to return to the Mamas for another expedition in September 1980. Results were written-up in after-work hours.

The last expedition in 1980 was joined by Pepen S. Abdullah, student of biology of the Universitas Nasional in Jakarta, who made two more trips to the Mamus study area in 1981 under WWF project 1907 - Indonesia, Gunung Louset, Rhino command - to check on anti-poaching activities and to collect additional data on the rhino.

1.4 - Previous research

Before leaving for Sumatra in December 1974, the author reviewed the most important literature on the Sumatran rhinoceros as a temporary assistant of the Department of Nature Conservation. A detailed review was published in 1974: *Dicerorhinus sumatrensis* (Fischer), The Sumatran or two-horned Asiatic Rhinoceros, A study of literature, Mededelingen Landbouwhogeschool Wageningen 74-16, pp 82. (also published as: Mededelingen Nederlandse Commissie voor International Natuurbescherming no 22, 1975). Since this publication covers the field in some depth, here only a brief summary will be given of some of the more pertinent references.

The Sumatran rhinoceros or Asiatic two-horned rhinoceros - *Dicerorhinus sumatrensis* (Fischer, 1814) - is the smallest of the five living species of rhinoceros. It occurred from the foothills of the Himalayas in Bhutan, through Burma, Thailand and Malaysia to Sumatra and Borneo. Its occurrence in the Indo-Chinese countries cannot be confirmed (Rookmaaker, 1980). It is characterised by the presence of two horns on the snout and two deep skinfolds encircling the body between the legs and the trunk. It is about 120-135 cm high at the shoulder and can weigh up to 1000 kilograms or so. The skin is dark and covered with short stiff hairs. The animal's eyesight is poor, but the senses of smell and hearing are very acute. It is usually silent, but sometimes makes soft low noises and when alarmed it snorts or barks. Single young are born at long intervals. Adult size is reached in about three years.

The Sumatran rhino is only found in dense forest, mainly in mountainous or hilly areas, but has also been recorded from low coastal swamps, and even swimming out to sea. Sumatran rhinos are usually solitary, but occasionally small groups of two or more are reported. The animals are great wanderers, capable of covering long distances apparently not deterred by thickets, thorns and steep slopes. They track around in a vast territory, occasionally wandering far out of their usual feeding grounds. Where they are common the rhinos maintain an extensive network of trails. They are most active during the night and rest during the hot hours of the day.

The Sumatran rhino swims freely and takes regular mudbaths, often in special wallows that are slumped by the frequent use. They are regular visitors to saltlicks. They are browsers and feed on leaves and stems of a great number of shrubs and trees, often pushing over trees to reach the crown. Occasionally fallen fruits are taken. Dung is often deposited in streams and occasionally in communal dung heaps. The males and females spray urine backwards onto the vegetation to scent mark. They often break and twist saplings along the trails.

This summarizes the knowledge about the biology of the Sumatran rhino before the recent fieldstudies (van Strien, 1974). The animal had been relatively rare for the last century, only to be found in difficult terrain in remote areas. Most of the information on its habits was derived from reports on accidental encounters with a rhino and from a few naturalists and hunters who developed a special interest in this animal.

The first author to write more than a few casual remarks about his own observations of the habits of the Sumatran rhinoceros, was Major G.E. Evans (1905). He recounts his experiences from many unsuccessful rhino hunts, adding other information and local tales. Ten years later G.C. Sherridge (1915) described his experiences from tracking and hunting rhino in a short paper. Some remarks from another rhino hunter, Mr. Mackenzie, are published by R.C. Wroughton and W.M. Davidson (1918).

In the thirties two more elaborate reports from rhino hunters were published. In 1935 W.S. Thom published an article in which he gives a detailed account of his observations on the habits of the Sumatran rhino in Burma, gathered during many years of rhino hunting. An even more important paper was published in 1939 by T.R. Hubback, who tracked rhino for many years in Malaysia. This paper contains a wealth of information, systematically arranged and entirely based on his own observations. All these reports were published in the Journal of the Bombay Natural History Society.

For a long time these reports were the only ones based on detailed personal observations of the Sumatran rhinoceros in the wild. They contain much valuable information, but very little of it is quantitative and it is often difficult to separate the author's own observations from repeated anecdotes and opinions from other sources. By the time Hubback's and Thom's papers were published the rhino had become very rare and in the following decades very little first-hand information on its habits and whereabouts became available.

The first scientists to collect more up-to-date information on the Sumatran rhino were Lee M. Talbot (1960), who visited the South Sumatra reserve and other locations in Asia for the Fauna Preservation Society in 1955 and Oliver Milton (1964), who visited some locations in

Sumatra for the World Wildlife Fund in 1963. The latter also visited Gunung Leuser, but, since he only traveled along the road from Kutacane to Blangkejeren, was not able to ascertain the status of the rhino in the Leuser reserve. In 1969 Rudolf Schenkel and Lotte Schenkel-Hulliger made the same trip to gather information on the rhino, again for World Wildlife Fund (Schenkel & Schenkel-Hulliger, 1969).

In 1970 Fred Kurt was contacted by WWF to do a more thorough survey, together with Walman Sinaga of the Indonesian Nature Conservation Division, of the status of the rhino and other animals in the Gunung Leuser reserve. They made several trips into the fringe areas of the reserve, and collected much valuable information. His reports (Kurt, 1970, 1973) led to the instigation of this study.

In the meantime David L. Strickland had made the first attempt at a systematic field-study of the ecology of the Sumatran rhinoceros, during ten months in 1965/66 in the Sungai Dusun reserve in Malaysia. He followed and measured tracks, mapped movements and collected samples of fecal pellets. From the size of the tracks he was able to identify individuals and make a rough map of the total ranges of three rhinos (Strickland, 1967).

In 1972 Marcus Börner started a three-year fieldstudy in the Gunung Leuser reserve, the results of which were published in a thesis (Börner, 1979). Besides a survey of the status of the rhino in the whole of Sumatra, he gives detailed descriptions of many aspects of the rhino's life, deduced from signs found in the field, concentrating on behavioural aspects of the feeding, defaecation, urination, tree-twisting etc. Again he used track measurements to distinguish between individual rhinos.

In 1975 Rodney W. Flynn began a fieldstudy of the Sumatran rhino in the Endau-Rompin area in West Malaysia, together with Mohd. Tajuddin Abdullah. The study concentrated on distribution and density and on aspects of foodchoice. A paper on the distribution, also using track size to distinguish between individual rhinos, was published in 1983 (Flynn & Abdullah, 1983). In recent years the small population in the Sungai Dusun reserve in West Malaysia has been studied to establish its approximate range (Mohd Zuber, 1983).

The use of indirect observations in the study of animals is an old practice, but usually it is only employed to study distribution and to estimate density. Counts of tracks, faecal pellets, nests, burrows, etc. can be related to density and these techniques are very useful for census of wildlife in habitats where the animals are difficult to see or hear. Track counts are one of the oldest wildlife inventory techniques and have been applied in various forms for many animals (van Laveren, 1982), but rarely has the study of tracks been so perfected that individual animals could be recognized with certainty. Apparently the only studies in which individual recognition of tracks were accomplished are those on the wild tiger in India. By measuring tracks and prints and tracing the outline of the prints onto a transparent plate, scientists were able to recognize several individual tigers from the size and form of the sole pads (McDougall, 1977; Panwar, 1979).

CHAPTER 2 - THE STUDY AREA AND GENERAL METHODS

2.1 - Selection and establishment of the study area

Formerly the Sumatran rhino occurred all over the Gunung Leuser Reserve, but in the last few decades poaching has exterminated it in all the more peripheral areas. By the beginning of the study, rhino could only be found in the interior of the reserve, at least a two or three days walk away from human habitation (see figure 2.1 and Borner, 1979).

During the preliminary expeditions (see chapter 1.3) to the Gunung Leuser and the Gunung Bantahara no recent signs of rhino were found. The steep slopes leading up to the Bantahara, that form the northeastern side of the Alas valley, have apparently never been favourite rhino habitat. Along the long route that leads to the Gunung Leuser only very old rhino trails were found, which had obviously been abandoned many years before. Already by the thirties no fresh signs of the presence of rhino were found in that area during the Clemens - Van Steenis - Hoogerwerf expedition (Hoogerwerf, 1939) and the George Vanderbilt expedition (Miller, 1942). Rhinos were exterminated there many years ago by the more or less professional rhino hunters from the Blangkejeren area.

We expected better results from the expedition to the Gunung Mamas, a route that had never before been opened. We hoped to reach the rhino area in the interior of the reserve crossing Gunung Mamas or that rhinos were still present on the higher slopes of the mountain. But again no fresh signs could be found. Some well developed rhino trails and some old wallows were found on the spurs leading up from the Alas and Mamas valleys to the main ridge of the Gunung Mamas, but it was clear that the rhino had left the area some ten to twenty years before. The higher slopes of the Gunung Mamas are very steep and deeply intersected. No signs of rhino were found there, and it proved to be impossible to cross over the summit into the Central Leuser Valley, where rhino were known to exist. The ruggedness of these mountains and the density of the vegetation in these parts of the reserve make travel very difficult and slow, and also rhinos seem to avoid these areas.

Therefore it was decided to try to find a suitable study area in the southern part of the reserve, where the mountains are less rugged and generally below 2000 metres in altitude, especially in the Central Leuser Valley. This valley in the centre of the Gunung Leuser reserve, running SE - NW, was discovered by a geological survey only two years before. From the surveys of Marcus Borner (Borner, 1973) it was known that this valley formed the core area of the rhino distribution. Borner surveyed the northern and middle parts of the Central Valley and had a study area in the extreme southern part of the valley.

The southern part of the valley, where it is drained through the Mamas and Siluktuk rivers, appeared to be the best area for rhino. The valley is widest there and the slopes are not too steep. Therefore it was decided to try to penetrate into the southern part of the Central Valley and to develop a study area covering most of the upper Mamas and overlapping in the south with Borner's study area. The only known entrance route into this area was the route used by Borner, an old rhino hunter's route, a walk of three to four days to reach the boundary of the study area. Since the Mamas river leaves the Central Valley through an impenetrable gorge, it is impossible to enter the valley following the river. The mountain chain which must be crossed to enter the valley is, on the Alas river side, steep and deeply intersected.

People who worked in the area were of the opinion that the rhino poachers had probably not yet penetrated into this part of the reserve, and it was deemed unwise to open up a new route into the very heart of rhino country since it would only attract poachers after the study had ended. Therefore it was decided to use a helicopter to carry the survey team in and out of the study area.

At that time the interior of the reserve had not yet been properly mapped and the only reliable map available was a radar map (SLAR) on 1:25000 scale, which gives only a rough indication of the topography. The mineralogical survey exploring Gunung Leuser Reserve in 1973 had used a heliport somewhere along the upper Mamas, but it was not known whether it was a natural or an artificial clearing in the forest. So on the first flight to the Mamas valley, in a helicopter borrowed from an oil company in Medan, a seventeen metre rope ladder was attached to the helicopter and lines were tied to the baggage, to enable us to descend if the helicopter could not land on the ground. As a last resort a known natural landing site, some twentyfive kilometres to the north could be used, from where it would be possible to reach the upper Mamas in a few days walking.

Fortunately soon after entering the Mamas valley the pilot spotted a small open space in the dense forest and he managed to land the party there safely. Because most of the valley had been under clouds, orientation was very difficult and only after a few days of mapping the major rivers could we identify the location of our landing.

The area appeared to be very suitable and it was decided to develop the study area there, with the base camp (Camp Central) at the landing site. Soon we found out that rhino poachers had entered the area a few kilometres south of the central camp, using a route over the mountains between the Mamas and the Alas valley. Because an entrance route already existed it was

no longer necessary for us to rely solely on helicopter transport, and we decided in future to use the helicopter to transport the party and the luggage to study the area but walk out along the poacher's route.

After the first landing part of the team started to survey and map the surroundings, while the rest began construction of the base camp and the landing platform. The platform, 5 x 5 metres, was made of 3 to 10 cm diameter poles, resting on small logs, in the middle of the open area. Some trees around were cut and during later expeditions a flight path was cleared to allow safer landings. On each expedition the condition of the poles was checked and any rotten wood replaced.

Close to the landing site at a convenient and safe place beside the river, the central camp was built. Like the other camps that were constructed later, it consisted of a raised sleeping platform made of poles, covered with a roof of a plastic sheet and large leaves. A covered fire place was used for cooking and for drying the fire wood and the clothes. On every expedition any rotten beams and poles were replaced or, when the camp had been demolished by elephants, it was rebuilt. The plastic roof had to be replaced every 8 to 12 months. Close to the central camp a store was built in the trees on a steep slope, to keep it secure from elephants. Here all food, equipment and collected material were stored.

To make it possible to cover as extensive a study area as possible, later more camps were made, each about 5 kilometres apart, and an extensive patrol trail system, following the major game trails, was cleared, marked and mapped (see the map of the patrol network in figure 2.5). On the second expedition two more camps were constructed, one about 4 kilometres north of the central camp (Camp Aceh) and another about 5 kilometres south of the central camp (Camp Pawang), at the point where the poacher's trail starts.

On the third expedition the southeastern extension of the study area was surveyed and a camp was built on the upper reaches of the Situkluk river (Camp Lukluk), 6 kilometres east of camp Pawang. The most northern camp (Camp Uning) was constructed on the fourth expedition, 3.5 kilometres north of camp Aceh, and from the seventh expedition on a camp (Camp Pinus), built by an anti-poaching patrol group, 6 kilometres south of camp Pawang, was also included in the patrolling schedule. By that time the patrol network had been fully developed and after the sixth expedition only minor additions were made to the system of trails.

2.2 - Organization of the expeditions

Because of the remoteness of the study area, some 35 to 50 kilometres of hard walking through rugged mountains from the nearest village, the expeditions had to be well prepared and organised. The survey party usually consisted of the author, his wife, and three to five experienced local aides. Whenever possible the same assistants were employed, not only because of their greater experience, but also to limit the number of people who would be familiar with the route to the upper Mamas.

Besides materials for the camps, the main part of the luggage consisted of food and plaster. Staple food included rice, dried fish, sugar, coffee and cooking oil, supplemented with chillies, onions, ginger root, pepper, salt and tea. All dry foodstuff was thoroughly sun dried and packed in thick plastic bags in 20-litre tins. All other luggage was packed in backpacks and bags, to enable quick loading and unloading. A detailed account of the logistics of the expeditions has been issued as an appendix to progress report no 6 (van Strien, 1977).

The helicopters were chartered in Medan from an agency or from the oil companies working there. Because of goodwill for WWF's cause, they were generally hired at a non-profit rate and costs could be kept as low as possible. But this meant that the machine could only be used if no-one else wanted to hire it and we often spent long periods of waiting in Medan till the machine was available. The helicopter had to be guided to Kutacane, over the Langkat mountains, where the rest of the team and the luggage was waiting on the landing site, on standby every day till the helicopter arrived. Usually it was not possible to contact the Kutacane team, because the local telephone or office radio were not available or not working. The excess capacity of the helicopter was used to carry extra fuel in jerrycans for the return journey.

From Kutacane the team was taken to the landing site at the central camp, on one or more flights, depending on the type of helicopter. Occasionally some food was dropped at another natural landing site near the most northern camp. The plastercasts and other collected material from the previous expeditions that had been stored in the forest were loaded aboard the helicopter and carried out to Kutacane. In the later stages of the study it became more difficult to arrange a helicopter and most of the later expeditions were made entirely on foot. When a helicopter was available a large quantity of food and plaster was carried to the study area to build up a stock of at least 50 days provisions in the store at the central camp. When no helicopter was available the team could walk to the study area, which took three or four days, depending on the load, without having to add a large number of extra carriers to transport food and supplies.

In the study area the team moved every two or three days to another base camp, from which daily patrols were made along the network of patrol trails. The team was generally split up into two or three groups to survey different areas or to do other duties, like repair or transport. Each expedition lasted three or four weeks, which proved to be about the physical and psychological limit under the circumstances. At the end of the expedition the collection of plastercasts was packed in old food tins, the stores were checked and the camps prepared for the next visit. The return journey began from camp pawang and it took 11 to 13 hours of hard walking to reach Kutacane.

2.3 - Description of the study area

2.3.1 - The Gunung Leuser National Park

The Gunung Leuser National Park (Taman Sumber Daya Alam Gunung Leuser) is one of the older and larger conservation areas in Indonesia and indeed in all of Southeast Asia. It consists of six adjoining Wildlife Reserves (Suaka Margasatwa), the oldest of which was established in 1934. Together they cover an area of almost 1 000 000 ha. In 1979 the whole complex of reserves was declared a National Park by decree of the Minister of Agriculture, but that does not change the legal status of the area.

The National Park covers more than 100 km of the Bukit Barisan range, the mountain chain that runs the length of the island of Sumatra. It stretches from the west coast of Sumatra in the southwest corner of the park, to less than 25 km from the east coast in the northeast corner, and is roughly located between latitudes 3° and 4° north and about longitudes 97° and 98° east of Greenwich.

The National Park is lengthwise almost split in two by the densely populated Alas valley. In the north both halves are connected by the Kapi Reserve, the last (1976) addition to the National Park. So far only part of the Park has been consolidated with legalised boundaries, and especially in the west and north of the park the boundaries are still provisional. Several important boundary realignments and additions to the park have been proposed in these areas. Figure 2.1 shows the location of the park, the approximate distribution of the rhino, and the study area. The rhino distribution shows only the core areas, based on the results of recent studies, but occasionally rhino are encountered outside these areas.

In the area of the Park the Bukit Barisan is most impressive, consisting of three big chains with several of Sumatra's highest mountains. There are many peaks over 3000 metres and also Sumatra's highest non-volcanic mountain (Gunung Leuser, 3445 m) is located in the northwestern corner of the park. A detailed description of the area and the park can be found in the management plan (van Strien, 1978).

2.3.2 - Physiography of the study area

The study area covers the valley of the upper Mamas river and the slopes on both sides of the river. The upper Mamas is part of a sequence of highland valleys called here the Central Leuser Valley. Others have used the name Central Rift or Blangbèkè (or Blangpòkè) Trench. The upper Mamas valley is about 2^a kilometres long, and about 10 kilometres at its widest point. It is located roughly between latitudes 3°15' and 3°30' north and at longitude 97°35' and 97°50' east of Greenwich. Figure 2.2 shows the topography of the surroundings of the study area.

The morphology of the area is strongly influenced by a system of parallel faults. To the west the deep Alas valley is a part of the Semangka fault that runs lengthwise through the centre of the Bukit Barisan. The valley is drained by the Alas river which breaks through the mountains south of the study area and flows to the Indian Ocean. At the time of the Toba eruptions (late tertiary - quaternary) the drainage of the valley was apparently blocked and a lake formed in the southern part. Heavy sedimentation took place but eventually the water found a new outlet through the chain, and the valley became dry. The flat alluvial valley bottom is fertile and now converted to paddy fields. The main urban centre of the area is the township of Kutacane, from where the expeditions were mounted.

The Alas valley is bordered on both sides by a steep, deeply intersected mountain range. To the east is the Serbolangit chain with the highest peak (Gunung Bandahara, 3012 m) at the northern end. To the west lies the West Alas Range, with the highest peak (Gunung Keotiri, 3314 m) in the north, but the range falls to below 2000 metres in the south, near Kutacane. This West Alas Range separates the Alas valley from the Central Leuser Valley, and is dissected in three parts by the very deep and narrow valleys of the Mamas and Katarobe rivers.

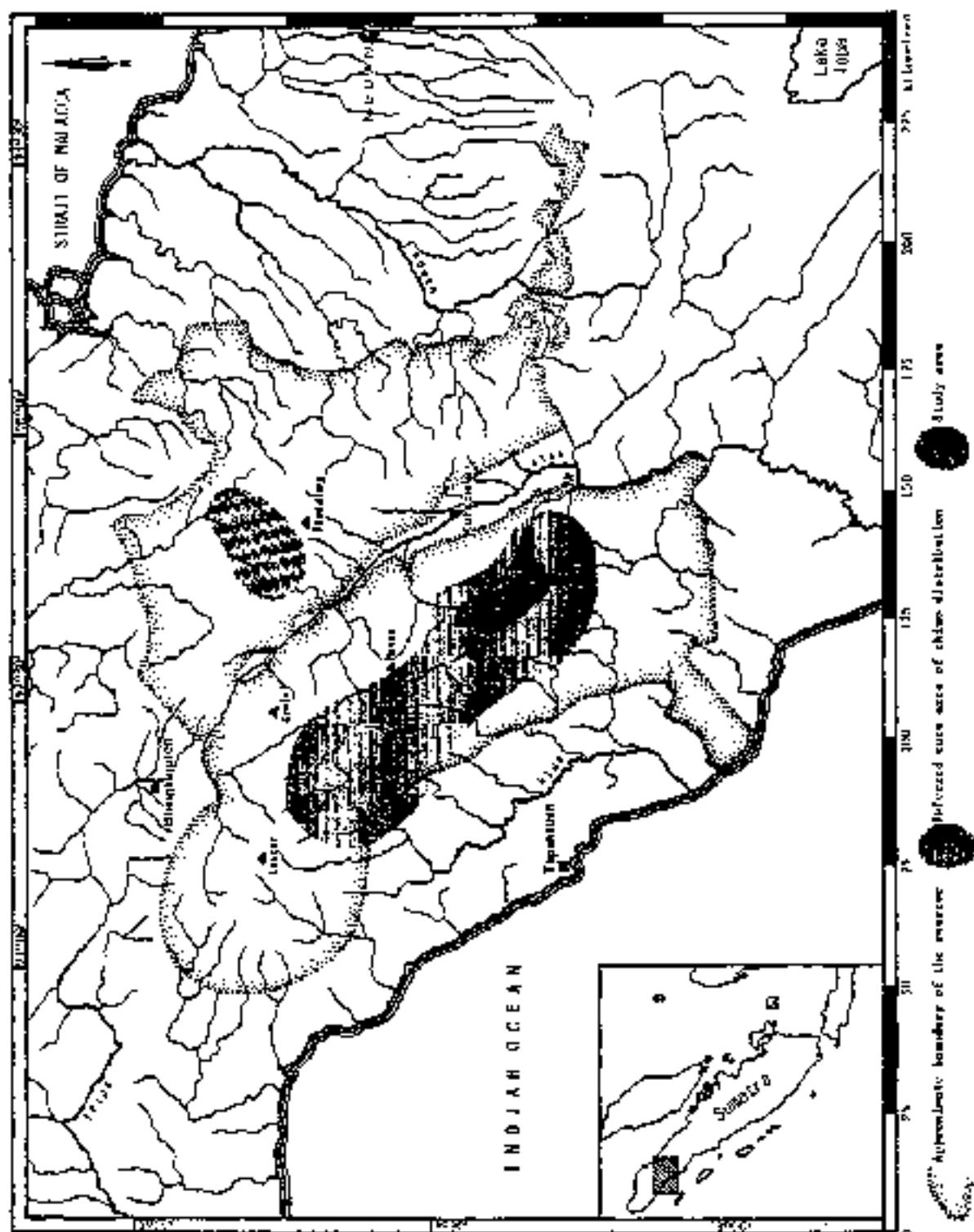

Figure 2.1 - Location map

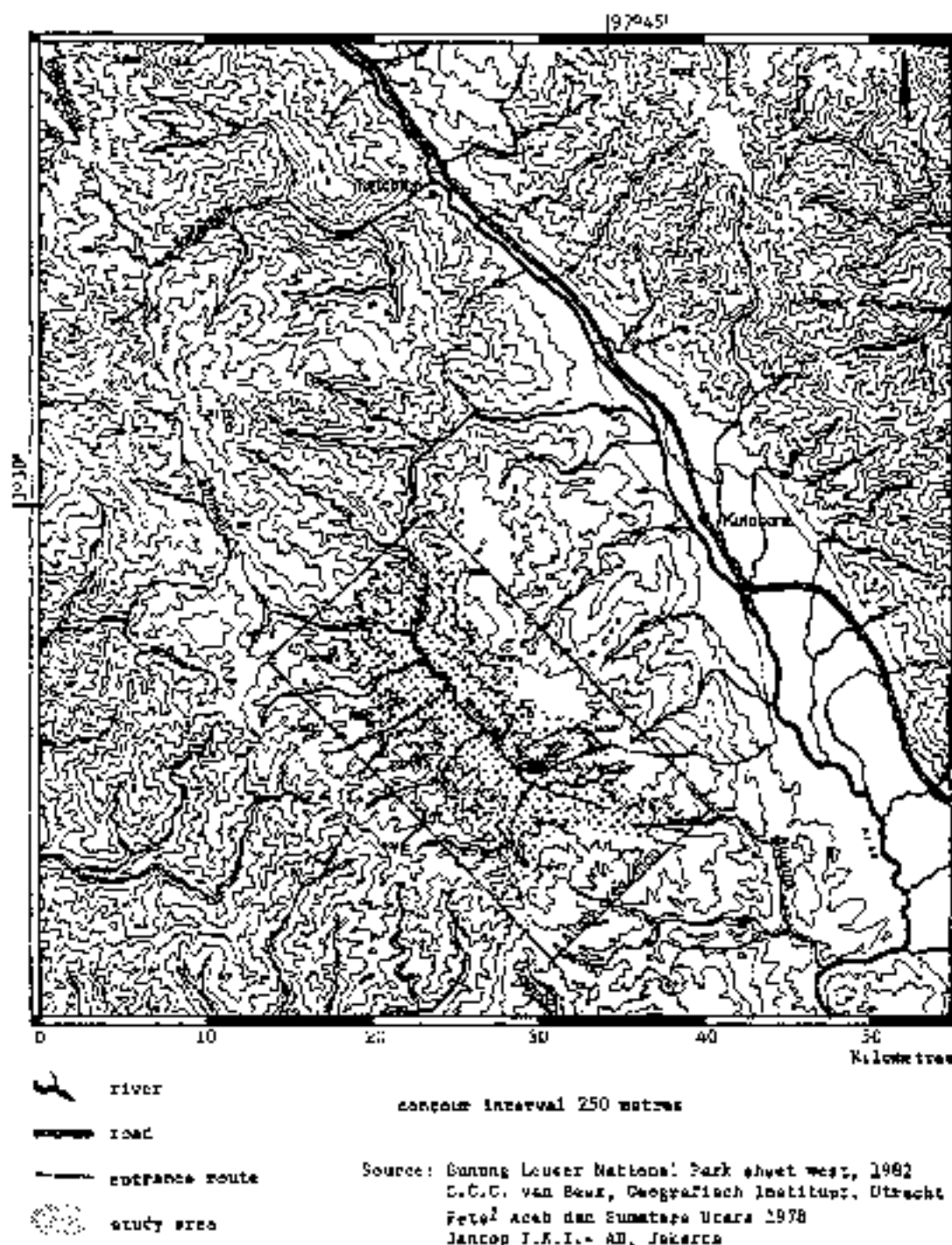
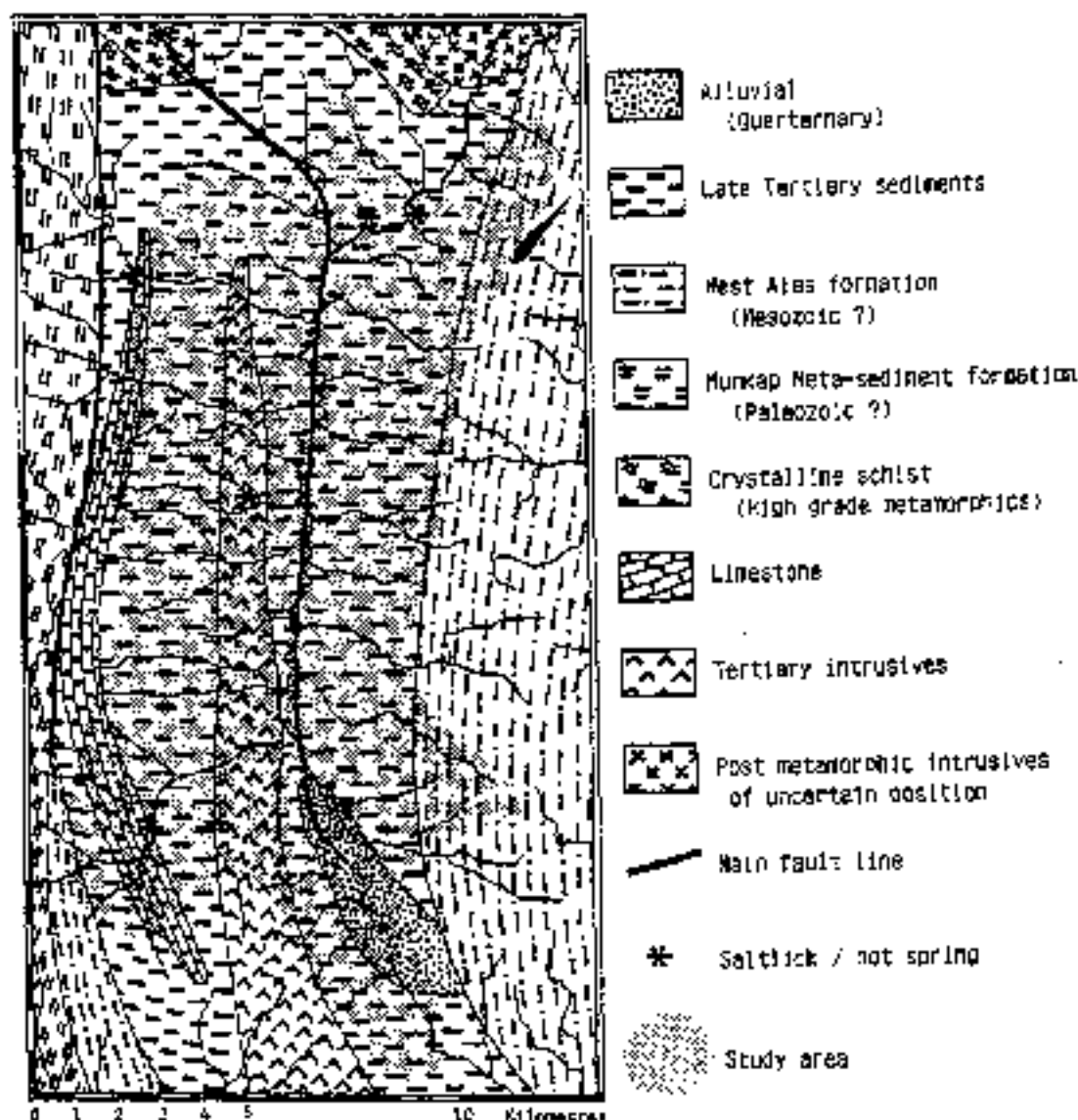

Figure 2.2 - Location map

The Central Leuser Valley is a series of highland valleys on a fault that runs parallel to the Alas faults. The northern part is drained by the Blangpeke river that joins the Alas river as it flows through the Agusan gorge. In the middle and southern part the fault cuts through preexisting drainage systems and the streams use the faultline for a short distance before breaking out to the side. The fault must therefore be of relatively recent origin (Quaternary). One small section of the trench drains to the west through a tributary of the Simpali river, then joins the Kluet river, running parallel to the west boundary of the reserve. A small section is drained by the Ketambe river to the Alas, and the southern quarter is drained by the Mamas river to the Alas. This part, called the upper Mamas, is a trench or a graben structure. The Blangpeke fault continues a few kilometres west of the river, approximately along the western limit of the study area, and the river follows a second fault, parallel to the main fault (see figure 2.3).



Source: Halokamp & Fogashiro, 1973

Figure 2.3 - Geological map of the study area

West of the upper Mamas lies the Leuser-Kluet range, the main range of the Bukit Barisan. In the northern half there are many peaks over 3000 metres, but to the south the mountains are lower, not much over 2000 metres. This range is deeply intersected by tributaries of the Kluet river. Most of the mountains west of the upper Mamas are composed of what has been named the Munkap-Meta-Sediments of Carbo-Permian age. It is a monotonous series of weakly metamorphosed black and grey phyllite, silt- and sandstone, with some limestones. The mountains east of the upper Mamas are covered by the West Alas formation, presumably of mesozoic age. They consist of black shales, silt- and sandstones, interspersed with zones of limestone and dolomites.

The basin of the upper Mamas itself is filled with sediments of late tertiary age, consisting of conglomerate, coral reef limestone, black marl, minor sandstone, agglomerate and crystal tuff. Especially in the upper reaches, towards the Sikuak river, they are covered with alluvial material accumulated from the adjoining higher areas. In the north the upper Mamas is bordered by a large area of intrusive and high grade metamorphics, granites and crystalline schists, that form the high mountains north of the Mamas. A narrow zone of tertiary intrusives, coarse-grained pink adamellites, runs parallel to the upper Mamas river.

The escarpment east of the Mamas river is steep, rising continuously to the watershed, at 1700 to 1900 metres. The side facing the Alas valley is even steeper, with nearly vertical

cliffs in many places near to the watershed. The rivers draining the eastern slopes of the Mamas valley are short, with the exception of the southernmost tributaries. Here the watershed is more distant from the valley and the ridges lead gradually up to the watershed at about 1900 metres, after a steep rise from the river. The trails leading to the Mamas follow these ridges.

In the south the Mamas river is formed by the confluence of two tributaries. One, the Sungai Tenang, drains the valley between the Mamas and Silukluk rivers. This is a wide valley, with a flat and locally marshy bottom, formed by the rapid accumulation of material from the unstable slopes south of the valley. The eastern part is drained by the Silukluk river, but the watershed between Silukluk and Mamas is very low and almost unnoticeable. The rivers and streams here are slow flowing and meandering. The other tributary, the Sungai Pinus, is a typical mountain river in a narrow steep-sided valley, with some alluvial deposits only in the lower two kilometres. In its upper reaches another small accumulation plain, called Medan Badak, has formed behind a massive landslide that blocks the valley.

West of the Mamas the watershed is about 10 kilometres from the river, drained by several fairly large tributaries. The largest is the Sungai Markus that drains part of the trench to the upper Ketambe river. Between this river and the Sungai Pinus there are three larger tributaries at right angles to the Mamas. These rivers separate the four major ridges leading to the central watershed between the systems of the Alas and Kluet rivers. These ridges form peaks, four to five kilometres from the Mamas, three of which are over 2000 metres. Behind these peaks the ridges are considerably lower, along the main fault.

The upper Mamas river falls only about 90 metres throughout the study area, and in most places slow flowing over a sandy or pebbly bed, with here and there bigger stones and boulders. The river meanders between the buffs of the mountains, depositing alternating patches of alluvium. Between camp Aceh and camp Uning the valley narrows and the banks of the river are steep and rocky, and beyond camp Uning the river enters a narrow and deep gorge, with cliffs a hundred metres or more high.

At several places along the faults springs occur, where warm water and gases emerge. The water is generally rich in minerals and around these springs encrustations and travertine domes can be found. The mineral-rich water and soil around these springs attract rhinos and other animals and are therefore called saltlicks.

The physiognomy of the study area is best demonstrated in the three-dimensional block-diagram (in the backcover), constructed from the 1:50 000 topographic maps produced in 1978 by the Indonesian Topographic Service (Jantop T.N.L.-A.D). The study area is shown from a point northeast of the area; the horizontal plane is on the original scale, but with an obtuse angle between the NS and EW lines, suggesting perspective, without shortening or convergence of lines in these directions. The vertical scale is five times (1:10 000) the horizontal scale to accentuate the topographic features.

Most data in this chapter are taken from studies by van Beek (1982) and Helmkamp & Negashima (1973).

2.3.3 - Climate and weather in the study area

The climate in the area of the Gunung Leuser National Park is characterised by high annual rainfall (average over 2000 mm/year), and the absence of a pronounced dry season. At lower altitudes temperatures are high and constant (tropical, average over 25° C), decreasing with increasing altitude. The humidity is high, and especially in the mid-altitudes, the air is saturated for most of the time. Cloudiness is high and in the cloud zone on the mountains there is mist on most days.

On the coast west of Gunung Leuser rainfall shows an annual cycle with two periods of high rainfall in March/April and in September/December, interspersed with periods of moderate rainfall. On the east coast the situation is different, with a dry season in the first half of the year followed by a wet season in the second half. The rainfall records from locations in the Alas valley show an intermediate pattern. There are two wet periods, in March/May and in October/December, with the second period having decidedly more rain than the first. So far all records are for locations below 1000 metres altitude, and these are not directly comparable to the conditions at the mid- and high-elevations (van Strien, 1978).

The rainfall in the Mamas study area follows essentially the same pattern as in the nearby Alas valley, but there are considerable daily differences. Daily rainfall records are available for the Ketambe Research Station (located in the Alas valley, about 30 km north of the study area, altitude about 350 m) since 1972. The average yearly rainfall there was 3125 mm (min. 1980 - max. 3591) for the period 1972-1980. The distribution throughout the year is shown in figure 2.4. Long-term records for Kutacane show a slightly lower average (2541 mm) (Institute of Meteorology and Geophysics, 1931-1960). In Ketambe the average number of rainy days (more than 1 mm of rain) per month varies from 13 in January to 23 in December (Min. 2 - Febr. 1973, max. 27 - Dec. 1973).

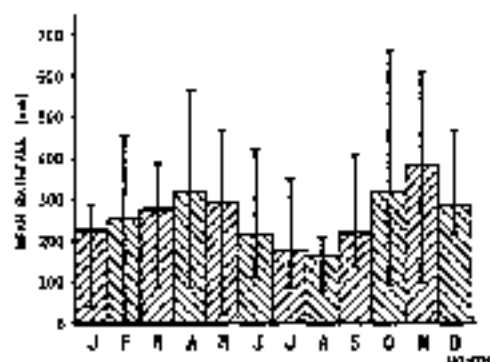

Figure 2a - Mean annual rainfall (shaded blocks) with the monthly range (the bars) for the Ketambe Research Station, 30 km north of Kutacane, 1972 - 1980

During expeditions daily notes were made of the rainfall - intensity (6 categories) and period - mainly for the purpose of the ageing of tracks. In the central camp a simple rain gauge was made from a small jerrycan with a small straight-sided funnel to collect rainfall. The first gauge was flattened by an elephant, but the second functioned for more than two years from the 6th till the 14th expedition. The gauge was emptied once every expedition and the amount of rain which had fallen since the previous measuring session was calculated.

Although the figures obtained with this instrument are not very accurate, they give an impression of the rainfall in the study area and it is useful to compare the results with those obtained for Ketambe. In the period that the gauge was functioning (13-VI-1976 till 1-IV-1979) a total of 7565 mm of rain was calculated for the Mamas (= 2867 mm/year), and in the same period in Ketambe 8671 mm of rain was recorded (15% more). From the eight measurements that were made during this period only two showed a higher rainfall in the Mamas, the other six were lower.

During the first fourteen expeditions (317 days in the study area) the number of days with rain was 177 in the Mamas and 176 in Ketambe. Comparing the notes on the rainfall intensity with the recorded rainfall in mm from Ketambe showed that on 162 days there was no apparent difference in intensity of rainfall, while in 32 days Ketambe had clearly more rain and in 73 days the Mamas received more rain. It therefore appears that in the Mamas the number of days with substantial rainfall is slightly higher (an estimated 200 to 225 days per year), while the total amount of rain is probably slightly less than in Ketambe.

The average temperature decreases with altitude and van Beek (1982) has calculated, from numerous records taken throughout the Gunung Leuser area, that the average decrease in temperature is 0.625°C per 100 metres of ascent. According to these figures the average temperature should be about 20°C in the lower (1200 m) parts of the study area, falling to 14°C at higher altitudes (2100 m). Every day during the expeditions the air temperature in the early morning (6.00 hour) was recorded, and maximum and minimum thermometers were placed at three locations. The daily minima recorded at daybreak in the camp sites (Altitude 1200-1400 m), varied between 11°C and 19°C , with an average of 16.2°C ($n=255$). Lower temperatures, below 13°C , were relatively rare and occurred only during the rainless periods when the sky at night is often very clear. When the expedition was based in camp Central (altitude 1270 metres), the daily maximum was also recorded. This varied between 20°C and 26°C , with an average of 22.6°C ($n=27$).

The maximum and minimum thermometers showed the following readings throughout their period of operation:

Altitude 1270 m	- minimum 11.5°C	- maximum 26°C	(period 880 days)
Altitude 1620 m	- minimum 11°C	- maximum 24.5°C	(period 599 days)
Altitude 2030 m	- minimum 10°C	- maximum 21.5°C	(period 285 days).

Wind velocities are generally low, although the trees are slightly deformed by persistent winds on exposed ridges and peaks. Before thunderstorms strong winds occur locally, blowing down trees and breaking off branches and occasionally large areas (up to one hectare) are completely flattened. Falling trees caused by gusts of wind are the main hazard in the area, and expedition camps have been destroyed several times by falling trees or branches.

The cloud zone is not very pronounced in the Mamas. Mist can occur at all altitudes, but is much more common and persistent above 1400 metres. But real moss forest, where everything is covered with thick cushions of moss up to several metres above the ground is not found in the Mamas. This type of forest covers extensive areas on the bigger mountain complexes, above 2000 metres.

As long as it is not raining the weather in the Mamas is very favourable for field work. During the day it is not too warm and one can walk far and fast, nor is it so cool that wading and swimming through the rivers becomes unpleasant. At night the temperatures are agreeably cool. Leeches and stinging insects are not abundant, with the exception of horseflies in the dry

periods and pestilential sand flies, that are occasionally so numerous that sleeping is almost impossible. Rain normally does not start before noon in the wet period. It continues generally till late afternoon, but occasionally it rains throughout the night and in the early morning. In the dry periods occasional showers occur, mostly in the late afternoon or early evening. Because the chances of finding clear tracks are dependant on the frequency of the rains, the expeditions were mainly concentrated in the periods with less rainfall, to have a better chance of working during a few dry days before tracks are obliterated.

2.3.4 - Plant cover of the study area

In this chapter only a general and superficial description of the types of vegetations found in the study area will be given. Extensive botanical explorations were undertaken in the Gunung Leuser area by botanists from the Leiden and Bogor herbaria. In 1979 the upper Mamas was visited by a team of botanists, who joined part of our 16th rhino expedition. In the chapters on the food of the rhino (chapters 8.1 and 8.2) more details will be given about the botanical makeup of the undergrowth, the stratum of main interest for the rhino.

Virtually the whole study area is densely forested. In the lower parts of the study area, in the large valleys and on the lower slopes, the forest should be classified as submontane. In appearance it is still decidedly tropical, but the trees are not so lofty as in the lowlands. The highest emergents are estimated to be not much more than 30 metres high, with trunk diameters rarely exceeding one metre. Buttressed roots are common. The Dipterocarps and strangling figs typical of lowland rainforest are not so common and much less imposing. Below the large emergents the forest is composed of a rich mixture of trees, large and small, but all with long straight trunks, with an abundance of small saplings forming most of the undergrowth. Lianas and epiphytes are abundant, as well as rattans and small, stemless or short-stemmed thorny palms. Large high-stemmed palms are absent.

Decomposition of litter is rapid and complete and the soil is generally covered with only a thin layer of dead leaves. Along the rivers and streams and on the lower, moister parts of the slopes, the herb layer is well developed, and there is an almost continuous cover of a mixture of fleshy herbs, one to one-and-a-half metre high. Higher on the slopes and on the ridges thorny palms dominate the undergrowth, forming a dense, prickly layer two to three metres high, in which visibility is very limited.

Ascending the mountain trees decrease and the boundary, at an altitude of about 1500 metres the forest becomes more like a temperate forest. All the trees are less than 15 metres high, and branching from the trunks starts at a much lower level. Lianas other than the cause of the is formed. A covers the where many

These ing condition greater altit shrubs can l small patch: dwarfed wit' of tall fern mass of ant are abundant areas occur. part of the

At warm spring with a gras with a thic' vegetation. the Situkluk the flat pa recent orig is similar l valley has crowns of

tion changes very gradually, the average height of the trees become more uniform. Although there is no clear boundary, at an altitude of about 1500 metres the forest becomes more like a temperate forest. All the trees are less than 15 metres high, and branching from the trunks starts at a much lower level. Lianas other than the cause of the is formed. A covers the where many

These ing condition greater altit shrubs can l small patch: dwarfed wit' of tall fern mass of ant are abundant areas occur. part of the

At warm spring with a gras with a thic' vegetation. the Situkluk the flat pa recent orig is similar l valley has crowns of

INDOCEROS

2.3.5 - The other mammal fauna.

Besides the Sumatran rhinoceros most of the larger Sumatran mammals are found in the upper Mamas, with the exception of the Tapir (Tapirus indicus) and the Javan rhinoceros (Rhinoceros sondaicus). The latter species is probably now extinct in Sumatra, but might once have occurred in some parts of Gunung Leuser. The tapir has never been recorded for Gunung Leuser, but was formerly found in the coastal plains of Langkat, east of Gunung Leuser (Schneider, 1905); now it probably no longer occurs north of lake Toba.

Elephants (Elephas maximus) are mainly found along the Silukluk and Mamas rivers, traveling to one of the saltlicks in the area. But occasionally they wander through other parts of the reserve and signs of elephants can be found everywhere in the upper Mamas, even on the tops of the mountains. Elephants enter the Mamas study area from the Silukluk valley or over the mountains between the Mamas and the Alas. The trail to camp Pawang is an important elephant route, but there is also an elephant trail along the watershed between the Alas and Mamas and probably from the lower Mamas to the saltlicks near camp Uning. From the Mamas area trails lead further north to the Central Leuser Valley. Among the regular visitors to the Mamas were two solitary elephants, one medium-sized and one large, and a group of three with a small calf.

Pigs (Sus scrofa) were only temporarily abundant in the upper Mamas, mainly in the flat area of Silukluk and Tenang. During the first two years very few sign of pigs were found, but later large groups were encountered in the south and also appeared more abundant elsewhere. It seems that they move into the upper Mamas during dry periods, often roving around in large groups (20 or more). The bearded pig (Sus barbatus) was not found in the Mamas, and has so far not been recorded for Gunung Leuser reserve.

The sambar deer (Cervus unicolor) and barking deer or muntjak (Muntiacus muntjak) are both common throughout the area. Sambar are found everywhere, even on the open sub-alpine areas above 3000 metres, while the muntjak seems to be less common at higher elevations. These two species use the same foods, the soft parts of the undergrowth, as the Sumatran rhino. Muntjak are usually found alone, while the sambar deer move sometimes in twos or threes. The serow (Capricornis sumatraensis) is less common and appears to be mainly found in the smaller and narrower valleys and on the steepest parts of the slopes. The mouse deer or kancil (Tragulus javanicus) is apparently very rare. Its tracks were only found once in the Silukluk area. The larger mouse deer or napu (Tragulus napu) was not found in the Mamas. Both species occur in Gunung Leuser, and especially the kancil is very common in the lower parts.

Of the larger carnivores the sun bear (Helarctos malayanus) and the wild dog or dhole (Cuon alpinus) are those most commonly found in the upper Mamas. Signs of both species were found often in the lower parts of the valley. The dhole was usually solitary, and only once were tracks of a small group of three or four found. In other parts of their distribution (Java, India) dholes usually operate in packs, chasing large herbivores. In the dense tropical forest a solitary way of life is probably more appropriate and from faeces, presumed to be dhole's, it appeared that in the Mamas dholes feed mainly on rodents.

The tiger (Panthera tigris) is a regular visitor to the Mamas. Tigers usually follow the network of game trails and their tracks could often be followed for a long distance. Tigers apparently wander around over huge areas, of which the upper Mamas is only a part. One very large tiger, whose tracks were easily recognizable (one toe had an aberrant position), was once found to have entered the study area from the north, traveled through the Mamas valley and left the area, a few days later, in the south near the Kompas river. Once a fresh tiger kill was found, an adult male orang-utan.

Tracks of the clouded leopard (Neofelis nebulosa) were found twice, but this arboreal predator might very well be more common. Borneo (1979) also reported the golden cat (Felis temminckii) from the area and tracks of the leopard cat (Felis bengalensis) were not uncommon. The hog-nosed badger (Arctonyx collaris) was encountered a few times, but it is probably rather common, and elsewhere in Gunung Leuser it was also found on the open sub-alpine blank areas.

In all rivers the small-clawed otter (Aonyx cinerea) is common and occasionally tracks were found of a larger otter (Lutra sp.). These tracks and the tracks of some medium-sized cats and viverrids that were occasionally found, await further identification from the casts made at the time.

The Southeast Asian porcupine (Hystrix brachyura) is common throughout the area. The black giant squirrel (Ratufa bicolor) was heard and seen several times, as well as small non-descript squirrels (Sundasciurus sp.). The three-striped ground squirrel (Lariscus insignis) was seen several times, but it is not very common in the Mamas. A few rats were collected at the camp sites. The large tree shrew (Tupaia tana) was seen occasionally. It was much less common than another small tree shrew (Tupaia javanica?) that was very often seen in the understory of the forest. Once a dead short-tailed shrew (Hylomys suillus) was found.

Among the primates Thomas' leaf monkey (Presbytis thomasi) is the most common species. It can be found at all altitudes, even in the shrubs on the very highest mountains. The whitehanded gibbon (Hyllobates lar) and the siamang (Hyllobates syndactylus) seem to be less

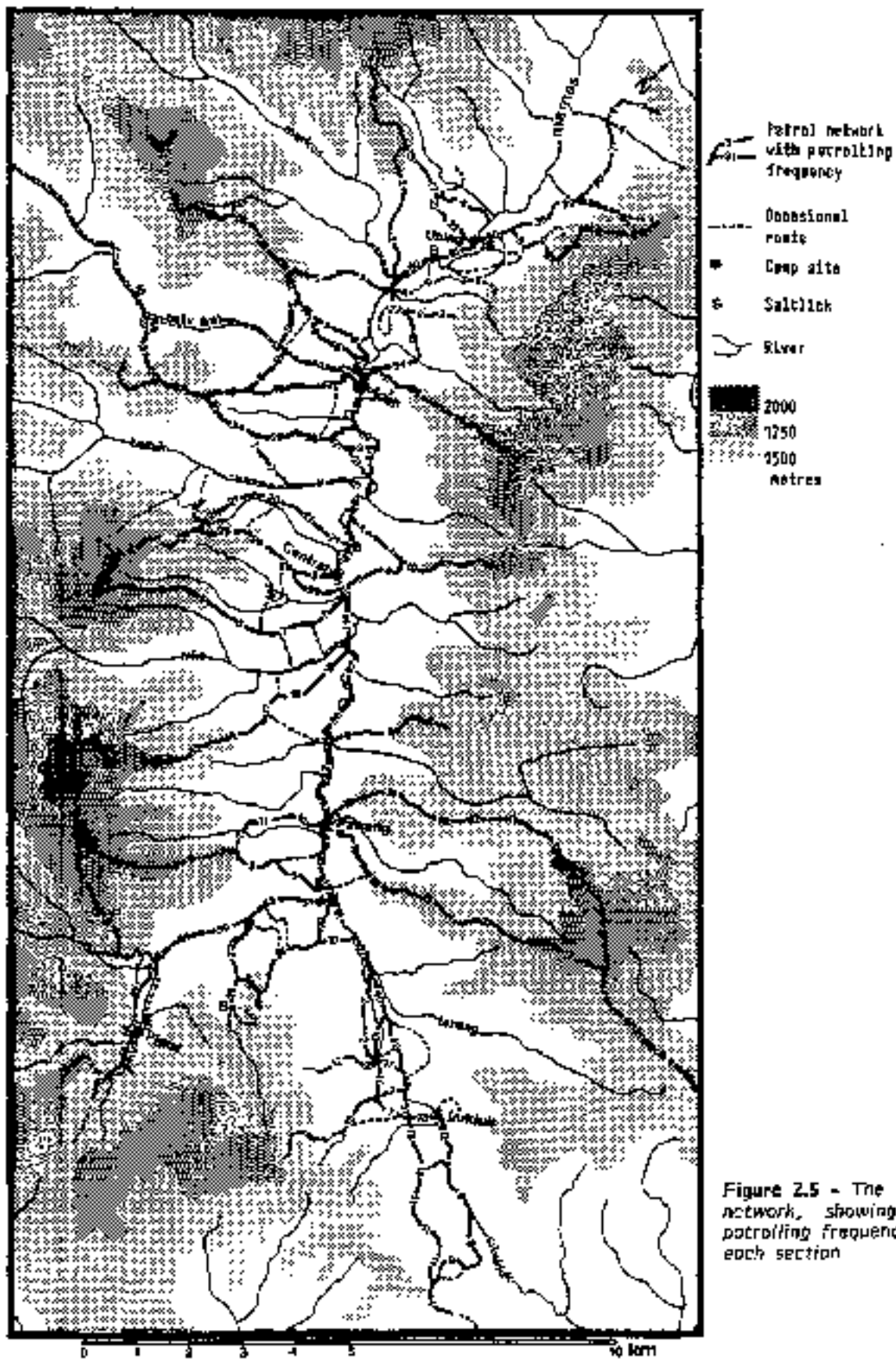

Figure 2.5 - The patrol network, showing the patrolling frequency for each section

common and they do not go so high. The gibbon occurs up to about 1900 metres, while the siamang has been recorded as high as 2200 metres. The orang-utan (*Pongo pygmaeus*) is much less frequently encountered but has been recorded up to 1800 metres. The pig-tailed macaque (*Macaca nemestrina*) is by far the rarest primate. A few groups were encountered below 1500 metres. The long-tailed macaque (*Macaca fascicularis*), essentially a lowland riverine species, was never seen in the Mamas.

2.4 - The patrolling system

Before this study it was generally believed that the Sumatran rhino has a very low density, at best one per 10 sq km, and therefore the study area should be large to increase the chances of finding tracks of more than a few animals. On visiting the future study area it was found that there was an extensive network of wide game trails throughout the area. They follow the major rivers, wherever the banks are flat, cutting off the meanders, and they lead up the mountains along the main ridges. It was decided to survey as many as possible of these trails and to develop a permanent network of patrol routes along these trails on both sides of the Mamas river. Using the game trails is the only way to cover a sufficiently large area in the available time.

The game trails along the bigger rivers and on the major ridges were generally well developed and needed only a little clearing of overhanging twigs and palm leaves, to make them easily passable. During the first six expeditions the network was gradually extended and six permanent camps were erected. The trails were mapped with the use of compass and pedometer, and trails were marked when necessary, by cutting a number in the bark of a tree. A detailed map was made of the area, using the field observations and radar maps, the only maps available at that time. When the new topographic maps, based on aerial photographs, became available in 1979, the working map of the study area could be further improved. By the sixth expedition about 150 kilometres of trails had been mapped, covering an area of about 170 sq km and most of the important saltlicks had been discovered. During later expeditions only minor extensions were made to the patrol network.

Figure 2.5 shows all the patrol trails as well as the other routes that were occasionally followed. Part of the entrance routes west of the watershed is also included in the network. For convenience the trails have been divided into sections of varying length. For section boundaries the contours at 1400, 1600, 1800 and 2000 metres were used, and also landmarks like willows and junctions. The actual length of each section was calculated to an accuracy of ten metres, from the fieldmap and the topographic map, taking the slope into account. In total there are 206 sections, ranging from 260 to 1880 metres, with a total length of 159 550 metres.

The patrolling frequency for each section is also shown in figure 2.5. This is the number of times that the team or part of the team passed a certain section, and it will be clear that large differences in patrolling frequency were unavoidable. The trails connecting the camps were walked many times for transport of stores and collections, while the number of patrols visiting the outward sections was much lower, depending very much on circumstances. Some routes were clearly more popular than others, because they led to important saltlicks or other areas where tracks were likely to be found. Since it was not possible to walk all routes during one expedition, there was never a fixed schedule, and the decisions where to go were made on a day-to-day basis, depending on the prevailing weather and the previous results. Therefore some sections were patrolled many times, while others were only covered two or three times throughout the study period. The differences in patrolling frequency can be compensated for by relating the findings of fresh tracks to the total observation time, which is the accumulated time between the time of the patrol and the last rain, as will be discussed in chapter 3.4.

The patrolling schedule was greatly influenced by the weather. During dry weather we attempted to cover as much as possible of the study area, visiting only the saltlicks and the major trails, before the coming rains would wash away the tracks. Camp was changed every other day, and two or three teams were sent out in different directions. But during periods of daily rains the area was covered more thoroughly, and more attention was paid to surveying new routes and to following rhino tracks. On a few occasions the downstream camps could not be reached because of the high level of the river. Early rain often prevented the completion of the patrol intended for that day.

During the patrols attention was mainly focussed on the finding of rhino tracks, both old and new. When a track was found it was followed until a few good casts could be made. Notes were made on the route of the animal, on the position and nature of signs such as feeding marks, faeces, urine etc., on the use of willows and saltlicks, and foodplants and faeces were also sampled. All signs of other mammals were also recorded and casts made of their tracks. The primates encountered in a 30 metre wide strip on either side of the trail were counted.

CHAPTER 3 - THE STUDY OF THE RHINO'S TRACKS

One of the initial aims of this study was to devise better ways to study the rhino's tracks so that more precise identifications could be made. During the first expedition it was attempted to trace the outline of rhino prints on a transparent plate, laid over the print. This method has been successfully used in the study of tigers (McDougal, 1977; Panwar, 1979). But it was soon discovered that it is not suitable for studies of the Sumatran rhinoceros. There were several practical problems. The transparent plate fogged when it was laid over the track because of the moist atmosphere, and the poor light in the rainforest made tracing very difficult. Furthermore the rhino's foot has a very pronounced profile, with long projecting hoofs, and a tracing shows only two dimensions, length and width, and nothing of the depth of the print.

Since tracing was not useful it was decided to revert to the classic method of casting prints in plaster of Paris, notwithstanding the serious transport problems that were involved in the use of this heavy material. For each cast 300 to 500 grams of plaster is needed, and large quantities had to be carried by back-pack to and from the study area, and carried around between the different locations. In total an estimated 350 kilos of plaster was used.

In the following pages detailed accounts are given of the methods used in the making of the casts and in the subsequent study of the casts to identify the individual rhinos. The technique could be applied with success to studies of other large animals, that are very difficult to observe. With slight modifications much of what will be said in the following pages could be of use in studies of other rhino species, elephants, tapirs, large carnivores, large bovids and probably even crocodiles.

3.1 - Morphology of the rhino's foot

Before the casts were finally sorted in Bogor, a short study was made of the rhino specimens held in the Bogor Zoological Museum (Museum Zoologicum Bogoriense). Skeletons, hides and hoofs of the Sumatran rhino, of which the museum has a substantial collection, were studied to get more insight into their structure to enable a better interpretation of the characteristics of the plastercasts.

The legs of a rhino are relatively short and columnar, ending in a flat sole with three hoofs or nails. In this typical perissodactyl foot the middle or third digit is the best developed, the second and fourth digit are slightly smaller and the first and fifth digit are completely lost. The forefoot carries most of the weight of the animal and is slightly larger; its print is a few centimetres wider and has rounder form than that of the hindfoot. Flynn and Abdallah (1983) found a mean difference of 1.5 cm between the width of the fore and the hindfoot. In normal gait the hindfoot overlaps the imprint of the forefoot almost completely, and only under exceptional circumstances, as on steep slopes or when the animal has made a sudden turn, can complete prints of the forefoot be found. During this study only a small number of casts were made of prints of forefoot. The form of the foot and the hoofs is similar to the form of the hindfoot, but the width is larger and also the nails are broader at the base. Only casts of hind-foot were used to identify individual rhinos.

The tarsus of the hindfoot consists of six bones, that are tightly joined, with each other and with the metatarsals. In this part of the foot very little bone movement appears to be possible. The tarsals and metatarsals act probably very much like a single piece of bone, articulating with the tibia. But between the metatarsals and the first phalanges there are joints that allow for considerable movement. In the third or middle digit the joint is almost cylindrical, allowing articulation mainly in the sagittal plane. The joints in the outer digits are more spherical, allowing movement in all directions. Most movement of the toes apparently takes place in these joints, while the joints between the phalanges appear to be only slightly movable. In figure 3.1 a left hindfoot skeleton is shown, drawn from a specimen in the Bogor Museum.

The extensor and flexor muscles that are attached to the digits generally have tendons to all three digits and between the digits there are strong ligaments (Beddard & Treves, 1889) and the individual toes are probably not meant to move separately. Only extension or flexion of all three toes together seems possible, but considering the weight of a rhino it is very likely that the differences in posture of the foot in descending and ascending (see chapter 3.5.3), are more the result of external forces than of muscle action.

The underside of the foot is composed of an elastic plantar cushion, several centimetres thick, on which the digits and the distal ends of the metatarsals rest and this is covered on the underside by the skin of the sole. This cushion distributes the weight of the animal and functions as a shock absorber. The skin of the sole is rather thin, in dried condition between 3 and 5 mm, with a thin horny outer layer. The flexibility of the plantar cushion prevents it being damaged by sharp objects (A cross section of a rhino's foot is shown in Grassie, 1955).

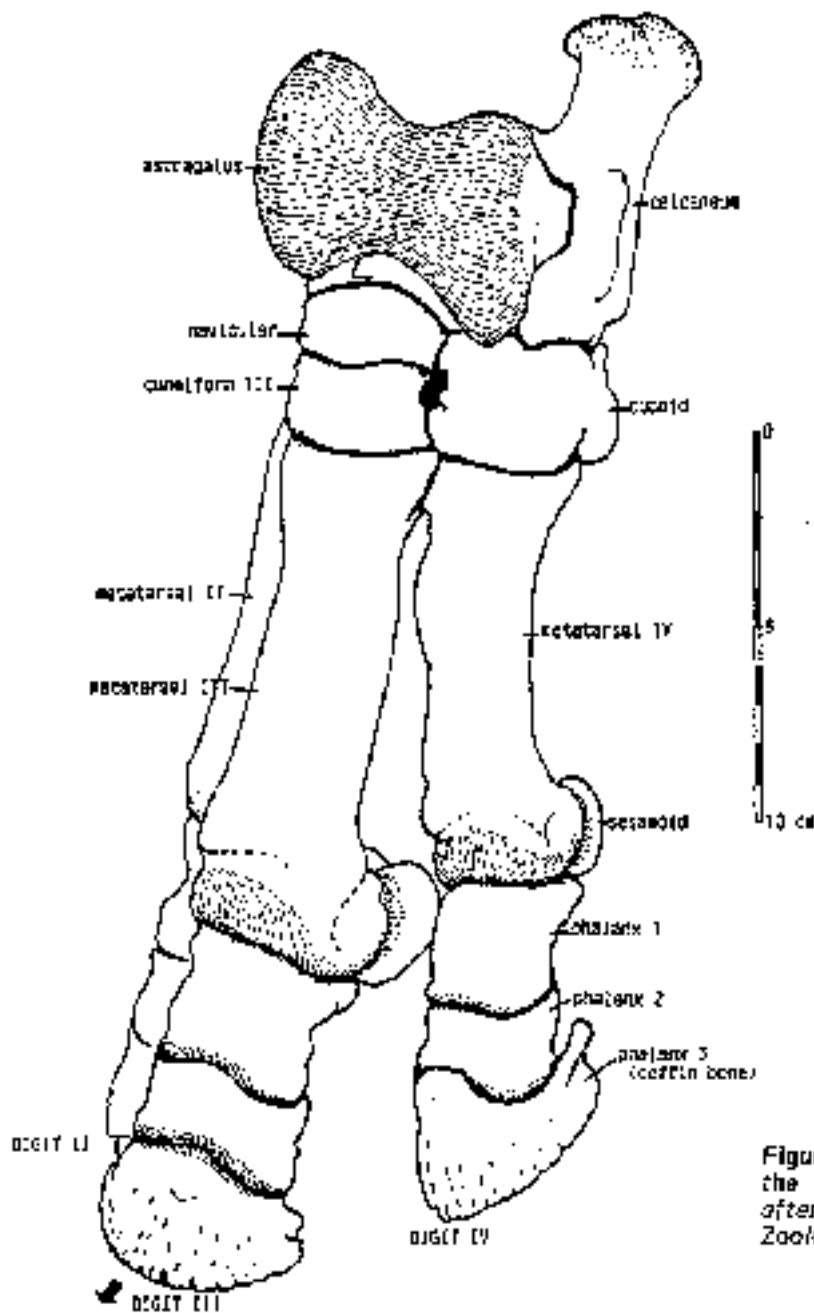

Figure 3.1 - Hindfoot skeleton of the Sumatran rhinoceros, drawn after a specimen in the Museum Zoologicum Bogoriense

The end phalanges or coffin bones are enclosed by a horny hoof, that is semicircular on the middle toe and triangular on the outer toes. The hoofs are made of horn and formed by the underlying horn-producing tissue. The hoof consists of a wall of solid horn that is formed by the coronary band, which is situated where the hoof attaches to the skin of the foot. On the inner side of the wall there are horny laminae for the firm attachment of the hoof. The flat inner side of the hoof, called the plantar surface or subunguis, is less solid and consists of horny tubules, formed by the underlying tissue (Emery, Miller & Van Hoosen, 1977).

In figure 3.2 a drawing of the underside of a foot of the Sumatran rhinoceros is shown, with the morphological names that are used in the text. The drawing is made from a specimen in the Bogor Zoological Museum. To illustrate the impression of the form of a foot in a plaster-cast of a print, figure 3.2 below shows a simulated drawing of an imaginary cast of the same foot. The morphology of the hoofs is shown in figure 3.3 in more detail.

The dorsal or outer surface of the hoof's wall is long and smooth, the inner side is very short, forming the basal ledge. In some hoofs the basal ledge is pronounced, in others the inner wall grades smoothly into the plantar surface. In the front hoof the outer wall curves around the sides of the hoof and forms the side lobes on the inner surface. In some prints these side lobes are thick and distinct, in others they are hardly visible and the inner surface of the hoof is smooth and flat. In the side hoofs the basal ledge has a groove in the middle, separating a posterior and an anterior lobe. The anterior lobe is generally the most pronounced.

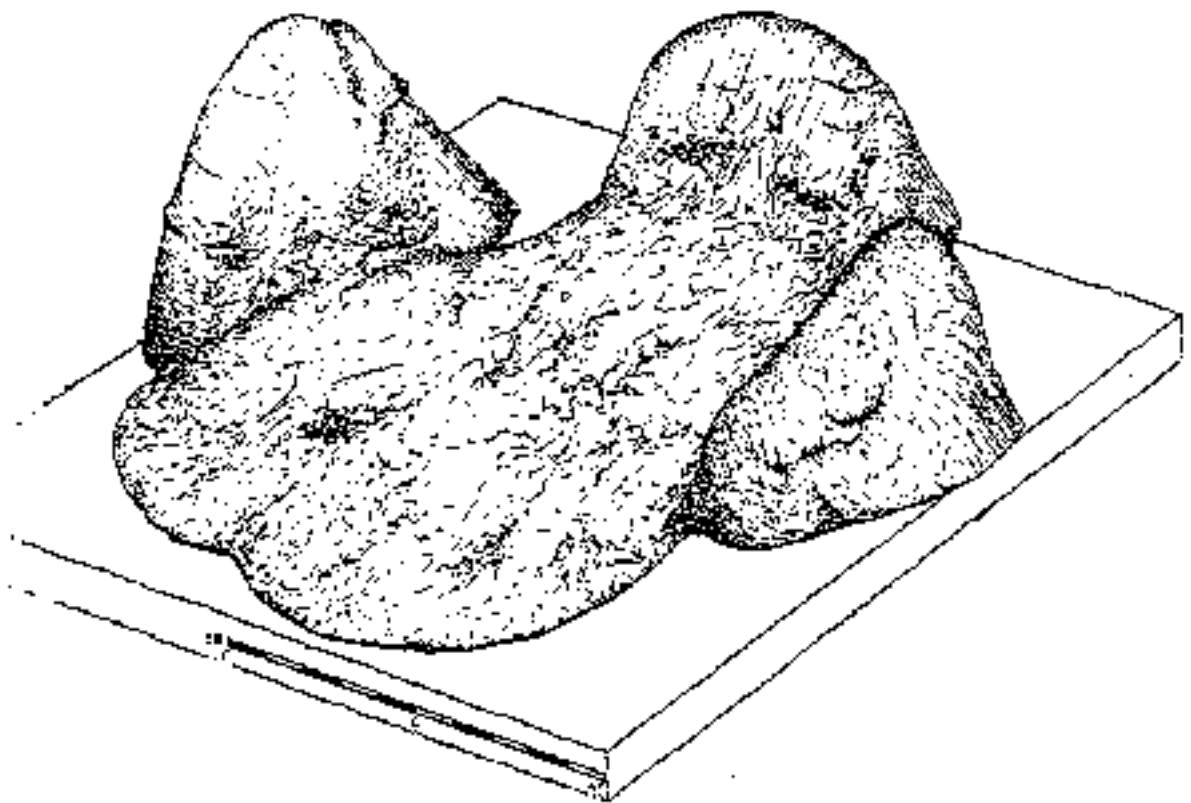
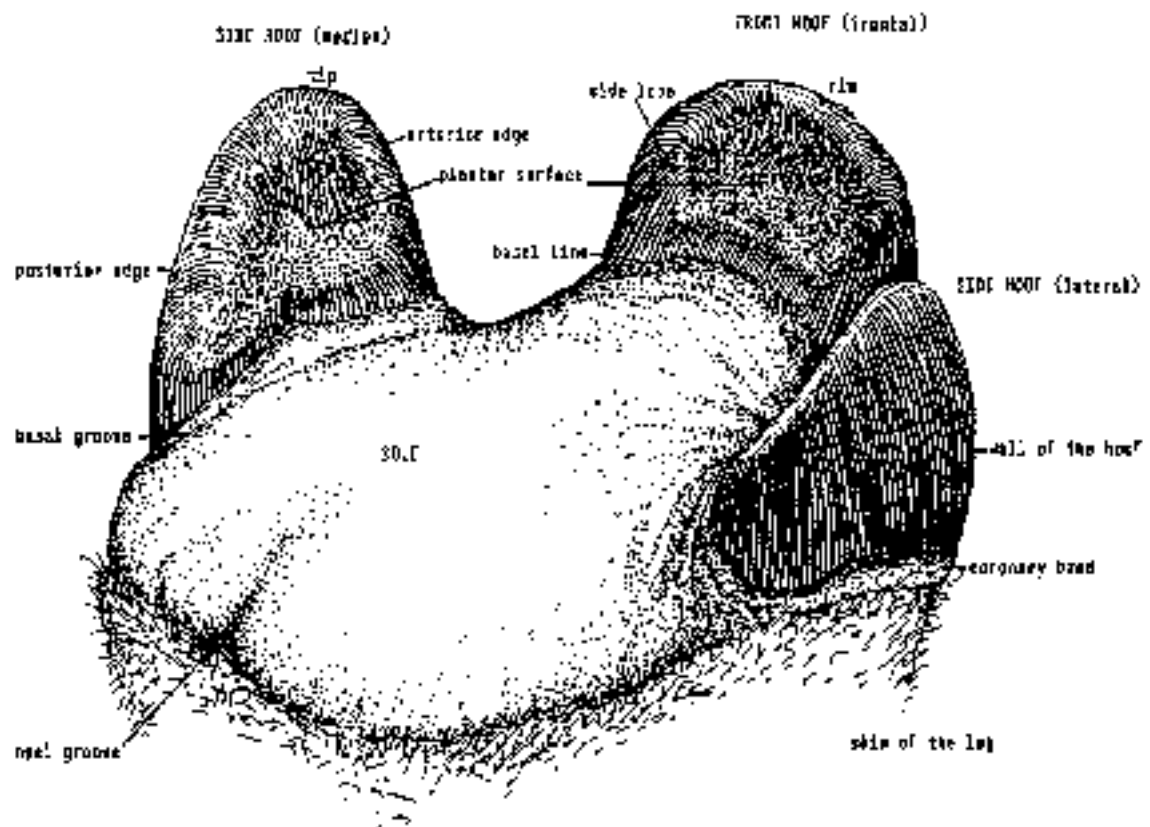

Figure 3.2 - The underside of a hindfoot of the Sumatran rhino (above), drawn from specimen (No 6970 and 8000) in the Museum Zoologicum Bogoriense, and a simulated drawing of a plaster-cast of the same foot (below)

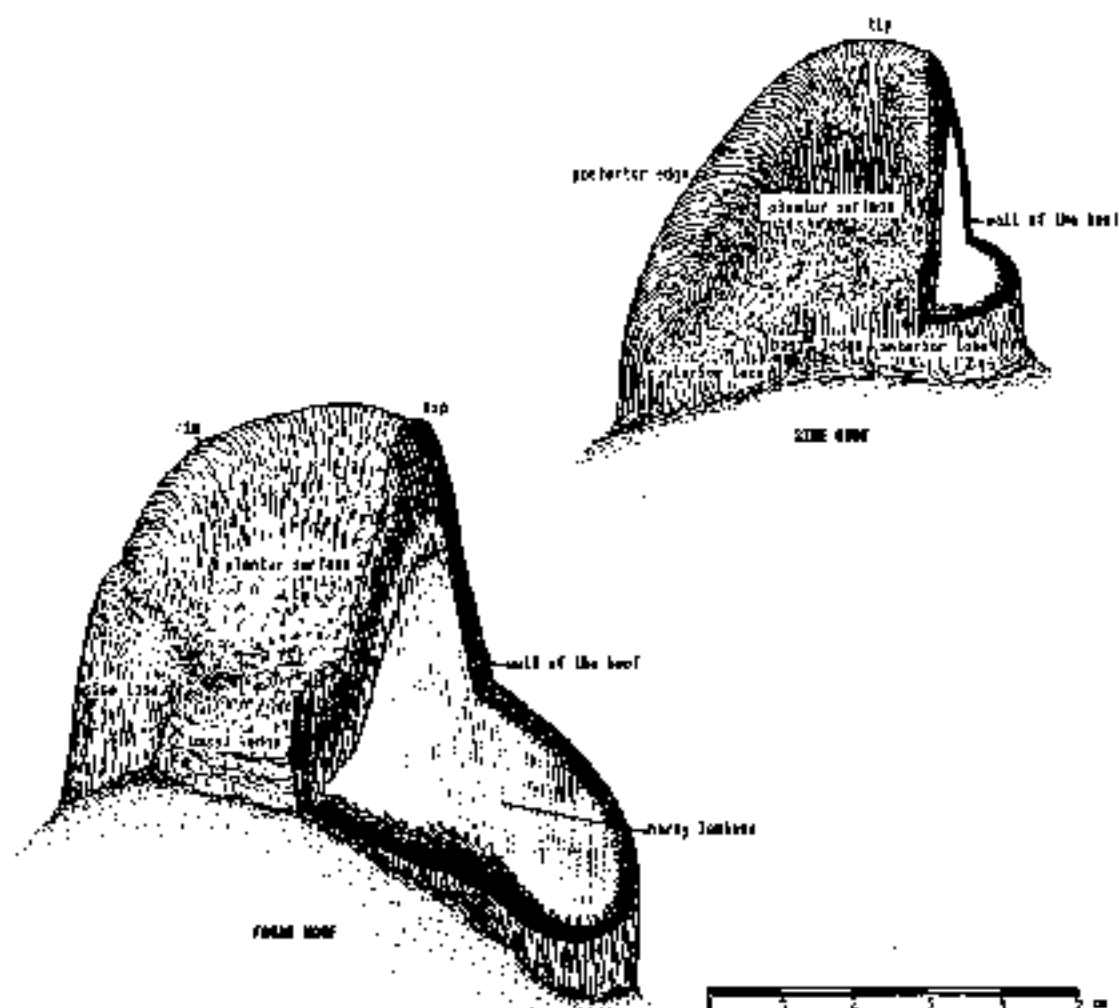

Figure 3.3 - The front and side hoof of the Sumatran rhino, sawn open to show the internal structures. Drawn from a specimen in the Museum Zoologicum Bogoriense

The Zoological Museum in Bogor contains a large collection of hoofs, confiscated by the government in the thirties, after the rhino had been declared protected in the Animal Protection Ordinance of 1931. These hoofs were measured and sketched to get an idea of individual variation, for comparison with the variation found in the actual plastercasts. All sets of hoofs were found to be clearly distinct and there was a great variation of sizes and forms. In figure 3.4 photographs and profiles of a selection of the front hoofs are shown.

It is remarkable that among the front hoofs from the Bogor museum, which originate from various localities in Sumatra and Borneo, many are of large size, well over 80 mm in width, a size that is relatively rare in the Mamas collection. This could indicate that the rhinos in the Mamas are relatively small, which is probably related to their mountainous habitat. Most of the museum specimens seem to originate from lowland localities.

opposite page

Figure 3.4 - A collection of outline drawings and photographs of front hoofs of the Sumatran rhino, to show the individual variation. Taken from specimen in the Museum Zoologicum Bogoriense

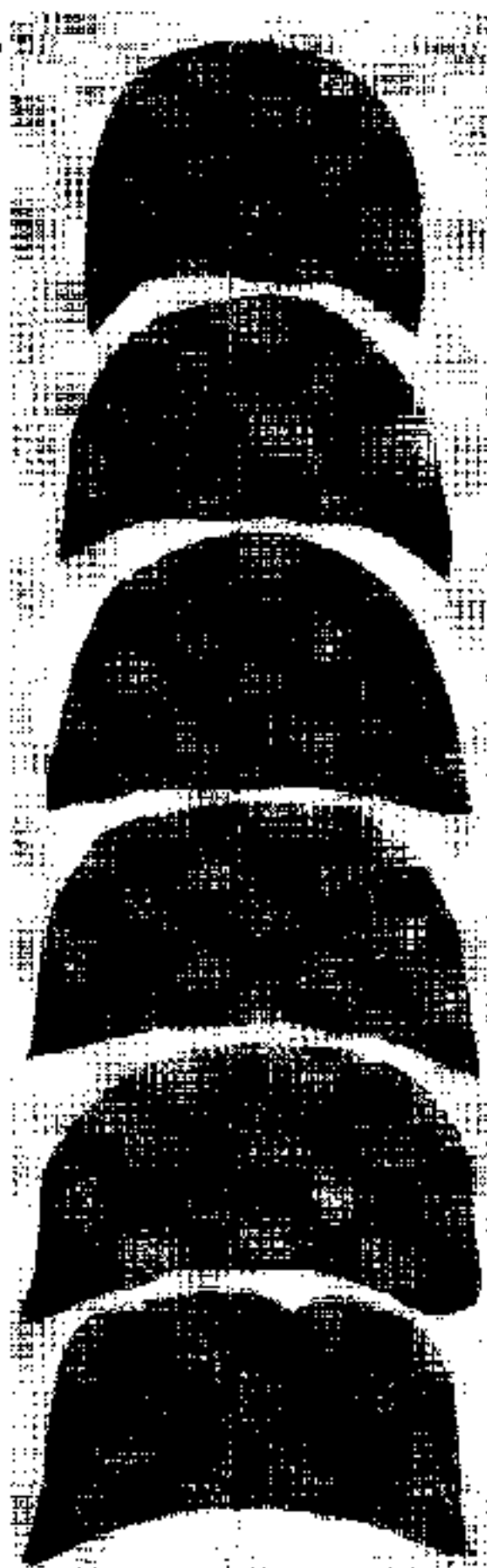
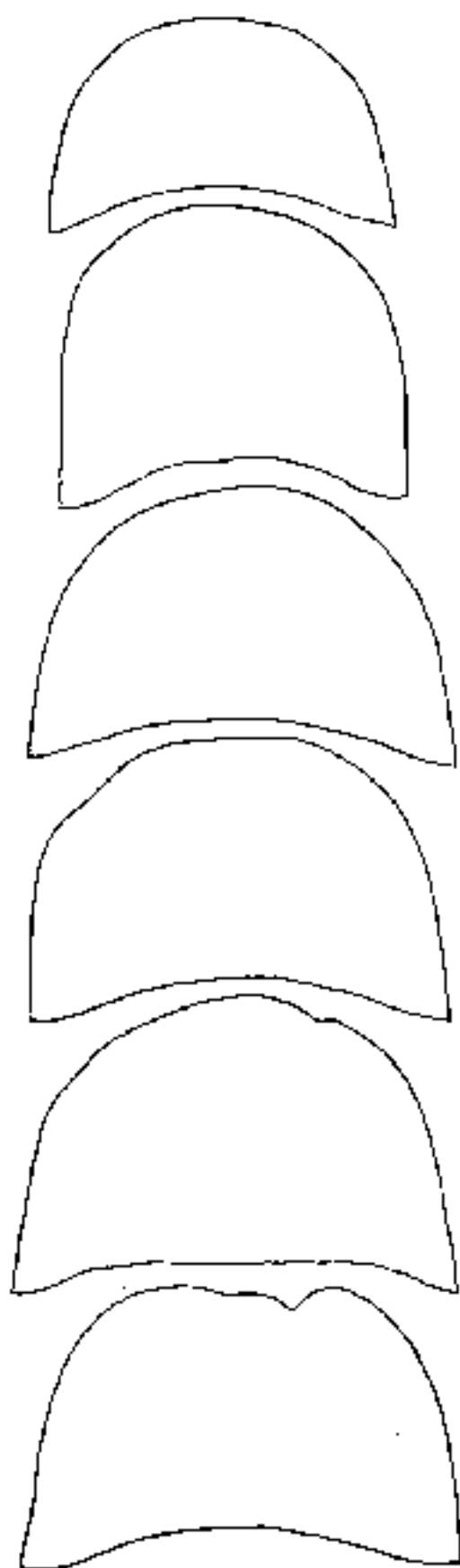
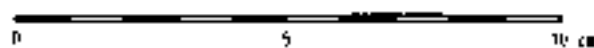

3.2 - The art of plastercast making

Rhino tracks are rare and good, clear and complete prints are rarer still, even in a good rhino area like the upper Mamas. Plaster is heavy and therefore always in limited supply in the field. Plastercasts are not only heavy, but also rather fragile. All of these factors together make working with plastercasts a craft, requiring much patience, experience, skill and a good organization. In this chapter the different techniques employed in the finding, making and presetting of the plastercasts will be described in detail, also as guidance to others who might wish to attempt a similar study.

The following figures serve to illustrate the frequency with which we encountered tracks of sufficiently good quality to make one or more casts. Plastercasts were collected from the second till the seventeenth expedition. During these expeditions 358 days were spent in the study area during which period 3816.42 kilometres were patrolled. During that period plastercasts were made from 360 different tracks, of which 166 were fresh. This means that on average one set of casts could be made per day in the field with an average 10.6 kilometres walked to find a suitably clear impression. Considering fresh tracks only, it takes about 23 kilometres of patrolling and a little over 2 days to find one fresh track.

Per expedition these figures vary widely, mainly depending on the weather conditions. The largest number of casts were obtained on the fourteenth expedition, when in 23 days and 295.4 kilometres of patrolling, casts were made of 53 tracks, 33 of which were fresh. The weather was very favourable during this expedition, with only two days with substantial rain. The poorest results were obtained on the fifth expedition, when in 24 days and 210.4 kilometres of patrolling only 3 tracks were found, in the first week of the expedition. In the last fourteen days of the expedition not one track, nor anything else worth recording, was found. During this expedition there were only five rainless days.

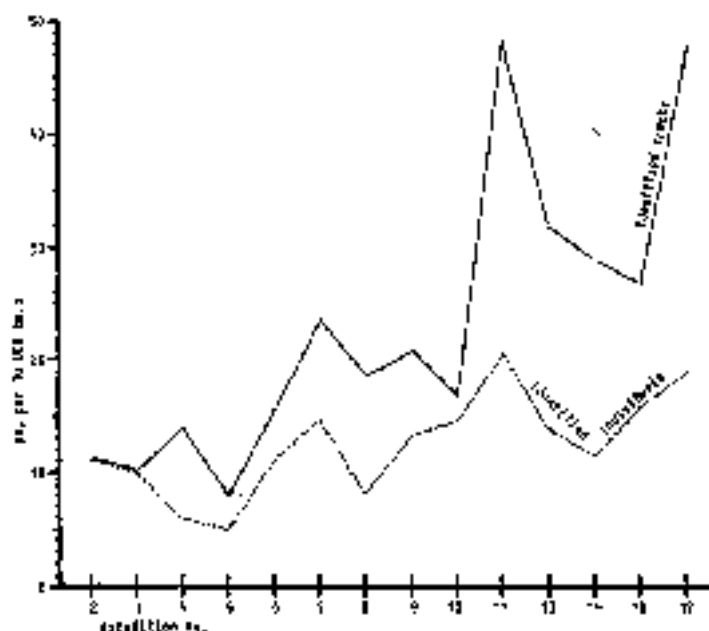

Figure 3.5 - The results of the track analysis per expedition, expressed in the number of tracks and the number of individuals that could be identified, against the km.h score for each expedition. The km.h score is a measure for the intensity of the patrolling (see chapter 5.4)

Experience is an important factor in identifying individuals from plastercasts of their tracks as is shown in figure 3.5, where the results for each expedition, expressed in the number of tracks that could be identified and in the number of different individuals that could be identified, are plotted against the km.h score (\rightarrow length of patrol in kilometres \times hours since last rains or previous patrol. This score is a measure of the probability of finding fresh tracks. See chapter 5.4). Both curves show an increase in numbers of useable casts and identified individuals from the earlier to the later expeditions. Some of this might be attributed to the gradual extension of the study area, during the first six expeditions, but most is due to increasing skill in the finding, selecting and casting of footprints, especially of older and less perfect ones.

3.2.1 - Finding the tracks

The first step in making plastercasts is to find the rhino tracks in the field. Under normal circumstances, and in the Mamas that means frequent rains and a moist soil, the tracks of a rhino are not easily missed. Even on relatively hard soil the sharp impressions of the hoofs are clearly visible and the track can be easily followed. But after a few rainless days the soil dries out, especially on the ridges, and rhino tracks become much less noticeable. The hoofs hardly leave any impression in the hard soil and the print is further obscured by the layer of fallen leaves which cover the soil. The longer the dry weather conditions last the more difficult it becomes to follow a rhino track, unless one proceeds on hands and knees and carefully moves the leaf layer to look for the shallow impressions of the hoofs underneath. Under these conditions it becomes increasingly difficult to find prints that can be cast.

Although the tracks are often surprisingly faint for an animal as large as a rhinoceros, they are not easily missed by the trained eye, especially when the animal follows the trail for some distance. Most patrols were made with groups of three or more people, each alert for rhino tracks. The one walking in front may miss faint tracks, because his attention is mainly concentrated on the area ahead, but the second and third person generally pick up the tracks missed by the front man. Most patrols go up and down along the same route and on the return journey we rarely found new overlooked tracks.

Prints are best preserved in places where there is no litter and the soils are clayey, around saltlicks, wallows and on worn out sections of the trails, or where the prints are somewhat protected against the rain by rocks, tree trunks or big leaves. During the study it was found that old rain-blurred tracks can sometimes be restored and useable casts made. The techniques to restore old prints will be described below.

3.2.2 - Selection of the prints

After a track has been found the prints to be cast have to be selected. In principle two right and two left prints should be cast for each rhino, but often this was impossible because four good prints could not be found or the plaster was in short supply. Sometimes when enough plaster was available more than four casts were made from one track, to get a longer series from which to study variations caused by the terrain. It is often not easy to judge the print before the cast has been made and lifted. In the dim light of the tropical forest fine details are difficult to see, especially in deep prints. A small mirror or a torch can be very useful for inspecting prints that appear to be suitable for casting. But even after careful selection of the prints, the casts often show deformations that were not noticed in the prints.

From old tracks it is often only a single print or just one or a few hoof prints that are suitable for casting. But fresh tracks suitable for casts are also generally rare. Prints left in normal forest soil are seldom good. The soil is crumbly because of the high content of organic matter and the layer of dead leaves obliterates the details of the print. Places with soil that leaves clear sharp prints are relatively rare in the forest. Generally good prints can be found only in those places where organic material cannot accumulate, as on saddles and narrow ridges or on steep slopes, or where organic material is removed, along rivers and streams or on the more frequently used game trails. When a rhino visits a saltlick or a major wallow, a fair number of suitable prints can be found, but when it wanders through the forest away from the large game trails, it is often very difficult to find enough good prints, and on several occasions not one suitable print was found although the track was followed for a considerable distance.

The type of movement of the animal influences the shape of the print (see chapter 3.5.3) and it is therefore important to select those prints, that are made on level ground, by a rhino moving calmly in a straight line. This is seldom possible in a mountainous area and one often has to take prints that were made under less ideal conditions.

When a larger number of apparently good prints were found, a number of them were cleaned out before a selection was made. Selected prints should be as complete as possible, showing a clear and complete imprint of all three hoofs and the hoofs should not have been forced into an unusual position by underlying stones or tree roots. Too shallow prints will not show the base of the hoof and too deep prints are difficult to inspect and are generally partly deformed with the sides caving in.

3.2.3 - Preparation of the selected prints

It was rare to find fresh prints that could be cast without being cleaned out first, and old prints generally needed extensive cleaning and restoration before a useful cast could be made. When the rhino lifts its foot in walking, particles of the loose top layer of the soil are dislodged and fall into the print. These particles should be carefully removed before the plaster is poured in. Even a few soil crumbs can prevent the plaster from filling the deeper parts of the print and important areas will be missing in the cast. The largest particles can be removed with the fingers. For smaller fragments a pointed twig or a pair of tweezers, made on the spot from a split twig (preferably a palmleaf stalk). The very finest particles can be blown out. To prevent more particles falling into the print the loose top soil is removed around the print.

In clayey soils removal of the soil particles is generally very easy, as the compacted clay forms a fairly hard layer around the print, but cleaning impressions in sand is more difficult, as the edge of the print is easily damaged. Generally some leaves or twigs are pressed into the print. If they are firmly embedded in the soil they should be left, but otherwise they should be carefully removed or the loose parts trimmed away. While cleaning tracks one should not tread on the soil immediately next to the print. In very sticky soils parts of the wall of the prints are partly or completely torn out when the foot is lifted, especially by the outer edge of the hoofs. These should be pushed back gently with the fingertips into the original position.

Cleaning and restoring of old prints needs more skill and patience, and often half an hour or more has to be spent on one print. Prints in sand or loose forest soils are very quickly leveled by the impact of the raindrops, but prints in clayey soils can withstand light rains and occasionally also survive heavy tropical rains. Light rain softens and joins the soil particles that have fallen in the print, gradually filling up the deeper parts of the prints. But usually this soil can be dislodged with gentle action by a pointed twig. In a way the soil fill protects the print against the mechanical impact of the rain. If the soil fill is very moist and the soil around the print still hard, it is best removed by washing with water. Water is poured into the print and the soil fill is loosened with a soft twig, or better still a soft brush. The soil-water mixture is then pumped out of the print with a syringe, which is used also for the final cleaning.

Only under exceptional circumstances can a print survive hard tropical rain. In very sticky and rather dry clayey soils, prints that are shaded from the rain by leaves, rocks, tree trunks or other objects can sometimes remain relatively unaffected and suitable for casting. Sometimes a thin layer of leaves is pressed into the prints and by gently pulling out these leaves, together with the soil fill, the form of the print can be clearly revealed.

Sometimes there were more good tracks and prints than there was plaster available to make casts. The prints that could not be plaster cast immediately were covered with a few large leaves or a piece of plastic, supported by a few twigs, to protect the prints against rain till the next day. Sometimes a film of clay was built around the print to prevent surface water from filling the print.

3.2.4 - The casting

The casts were made with medical or dental plaster of Paris, derived from the mineral gypsum ($\text{CaSO}_4 \cdot 2\text{H}_2\text{O}$). When the powder is moistened it becomes hard or sets. The dental plaster is more expensive, but finer and hardens better. If properly mixed the cast made from dental plaster is fairly strong and can be made thinner, thus saving weight. Dental plaster is sold in Indonesia in convenient 1 kilogram packages. Depending on the size of the print, between 300 and 500 grams of plaster are needed for one cast. Each patrol group usually carried 2 or 3 kilograms of plaster and during the study an estimated 350 kilogram of plaster was used in the field.

The plaster is mixed in an old tin, generally a two-liter cooking-oil tin, with a spatula cut from a branch. Water is taken from a nearby stream or puddle or from water flasks. First the plaster powder is poured into the mixing tin and then water is added gradually, stirring vigorously, until the mixture has the consistency of a smooth light batter. With too little water the mixture will not pour easily, but more water can be added quickly. If too much water has been added hardening takes a long time and the cast will be soft and brittle. In this case more plaster can be added, but it is difficult to make a smooth mixture before it starts to set.

The less water added to the mixture the better, as the cast will harden faster. But the mixture soon starts to set and it must be poured quickly, within one minute of mixing. When the plaster mixture is ready, the impressions of the hoofs are filled first, using the mixing spatula to direct the flow. Then the rest of the print is covered with a thin layer of plaster. When the first layer has thickened somewhat, a second layer is poured on the basis of the hoofs, to reinforce the cast.

When water or very soft mud is left in the prints, the mixture should be made as thick as possible and mixed with the water or mud remaining in the print, using the pumping action of the syringe. If the print is full of water that cannot be pumped out, a very thick plaster mixture is poured in and later more plaster powder is added and left to sink and settle. Casts made in this way remain very soft. Once the plaster has set it will not soften again and the cast can be left in the print and collected later. When the plaster is properly mixed it hardens in 15 to 25 minutes, but maximum hardness is only reached after one or more hours and thorough drying.

After the cast has hardened sufficiently - when a finger nail leaves only a superficial scratch - the cast must be lifted carefully from the print, and the necessary data are scratched on the back. It is generally necessary to dig out the soil surrounding the cast, with a stick or bushknife, then dislodge the casts with one's fingers. Pulling gently upward with both hands will dislodge the cast, but part of the hoofs may break off. The casts were wrapped in soft leaves and carried to the camp, for cleaning with water, using the fingertips to rub off the soil and a pointed twig to clean out hollows. It was then dried as thoroughly as possible. Casts were carefully wrapped in paper and plastic and put in the empty food tins for carriage out of the study area. Each 20-liter tin can hold about 12 casts.

All casts were numbered in the field, and the number with the side (right or left) were scratched on the back of the sole and on each nail. After the casts had been mounted for further study, a new number was given. All casts from one track were given the same number, with a decimal number for each cast, eg. 12.1, 12.2 etc.

3.2.5 - Preservation of the casts

After the casts had been transported out of the study area, they were preserved and prepared for further study. Most of the casts were broken, either when they were lifted from the print, or later in transport. Sometimes they were even deliberately broken to allow tighter packing in the tins. It was generally not possible to dry the casts in the forest and therefore they were later dried in the sun for a few days, until the plaster was thoroughly hard. The data originally scratched on the back of the cast was copied on the front, in china ink, and each cast was mounted on a piece of wood, roughly 21 x 27 cm. The broken off pieces were carefully replaced in the original position, and the whole cast was glued firmly to the wooden base with synthetic neoprene wood glue.

When necessary the back of the cast was planed with a kitchen rasp, and protruding parts were supported with pieces of wood or plaster or white cement. Mounting the casts is very precise and time-consuming work. One of the local assistants developed a special skill for this work and mounted most of the casts.

When the casts were mounted they were dried once more, the last soil particles were removed with a needle and a brush, and they were coated with clear varnish, two or three times. Collection numbers etc. were painted on the wooden base. The finished prints were stored in special boxes, long enough for 10 to 12 casts. Three of these boxes fit like drawers in a wooden crate. To protect the tips of the nails of the casts a piece of foam rubber was glued to the back of the wooden base of each cast. All casts were transported from Sumatra to Java in these crates, wrapped in paper, plastic and foam rubber.

3.3 - Aids for comparison of the casts

Several techniques were developed to describe, recognise or quantify the characteristics of the casts. It is impossible to capture every aspect of a cast in a set of numbers or pictures, but some characteristics can be expressed in measurements or drawings and this makes comparison easier. After some trials three techniques seemed the most useful; stereophotographs, outline drawings and sets of standard measurements. The stereophotographs were made as backup material in case the cast is lost or damaged. Outline drawings on tracing paper were used to compare the dimensions of the various casts by overlaying them on a light table. The standard measurements were not used in the sorting process, but only afterwards to find out which measurements on a print are most useful for a simplified identification system.

3.3.1 - The stereophotographs

Although stereophotographs were primarily made as backup material, occasionally they were also used to check the features of certain casts. The stereophotographs were made on normal 35 mm black-and-white film, with a 50 mm lens. The cast was positioned in a calibrated frame at the bottom of a special wooden stand, supported by three sliding wedges. By moving the wedges the cast could be placed in a standard position.

The camera was mounted in a slide on the top of the stand, allowing the camera to move parallel with the focal plane. The distance from the focal plane to the film was 83 cm and the best stereobasis (the distance between the positions where the two fotos were taken) was experimentally established as being 50 mm. The pictures were exposed with the help of an automatic electronic flash. The prints were mounted as stereo pairs and filed by collection number. Some are used to illustrate the ensuing chapters. For the stereoscopic effect a pocket stereoscope can be used.

3.3.2 - The outline drawings

From each cast an outline was drawn to scale on thin tracing paper. These drawings show the precise contours of the sole and the hoofs, with the hoofs folded out in the plane of the sole. On a light-table several of these outline drawings could be viewed together superimposed one upon another and easily compared. Next to direct comparison of the casts this was the most useful method of comparison.

The drawings were made with the help of a drawing compass and a profile gauge, an instrument consisting of a row of parallel metal bars that slide in a holder. How the profiles and outlines are taken from a cast is shown in figure 3.6. First the points between which the outline will be constructed are indicated with a fine-tipped marker on the cast. The points A form the two base points from which the rest of the outline is constructed. They lie on the basal groove of each side hoof, where this groove is crossed by the contour of the posterior edge of the side hoof, when looking vertically down on the plantar surface of that hoof. The points B are constructed similarly with the frontal edge of the side hoofs.

Point C lies in the middle of the basal line of the front hoof and point D in the heel groove. The other points are placed on the hoofs, point E in the middle of the rim of the front hoof, and the points F on the tips of each of the side hoofs. The tip of the side hoof is that point furthest from the middle of the basal groove. Finally two points are selected on the plantar ledge, the points where the ledge is thickest in the posterior and anterior lobe, of each side hoof. Now the distances between the points A and between the points A and the other points on the sole are transferred to the paper with the drawing compass, fixing the position of each point (A' to D'). The lines between the points A' and D' and between the points B' and C', the contours of the sole in an imaginary transversal plane, are then sketched in.

The outlines of the hoofs are made separately. The outline of the rim or edge is taken with the profile gauge, pressed against the rim of the hoof, parallel to the plantar surface of the hoof, until the rods close nearly around the cast. The rod that rests against the points B or F is pushed back to indicate the position of these points (E' and F') on the rim, and the profile is transferred to paper. For the side hoofs two overlapping profiles are taken, one from the posterior and one from the anterior edge. On the outline of the side hoofs the position of point A' is fixed with the drawing compass and from the points A and F the position of the points B and G are fixed and finally the plantar ledge is sketched through the points G'. On the profile of the front hoof the position of point C is taken over (G'). When all profiles are finished they are drawn again and joined in the points A', B' and C', on another paper, with the line A'A' in a standard position. Collection numbers, measurements and other data are written on the sketch.

3.3.3 - The standard measurements

Five measurements were taken from a cast, because they give the most consistent and complete characterization of its overall form, and because the measuring points can normally be located fairly precisely. They can also be taken from a print in the field.

Two of the five standard measurements are taken from the cast, the others from the outline drawings. On the cast the width between the tips of the side hoofs - the points F - is measured with a pair of compasses, and the width of the front hoof is measured with calipers.

The width of the front hoof is measured between two points on the sides of the hoof, as close as possible to the tip, because the base of the front hoof is often not clear in the cast. Because the selection of these points is critical for the outcome of the measurement, a whole series is usually measured together to reduce bias. Figure 3.7 shows some different front hoofs and the positions where they should be measured.

On the outline drawings the width of the sole is measured between the two base points A' and $A'E'$ is measured on both side hoofs and added with the width of the sole to give the distance $F'A'A'F'$, called the span. The distance from the middle of the line $A'A'$ (aa) to the point C' and the distance $C'E'$ are also measured, and together give the length of the sole. All measurements were taken to the nearest millimetre and recorded with the outline drawings.

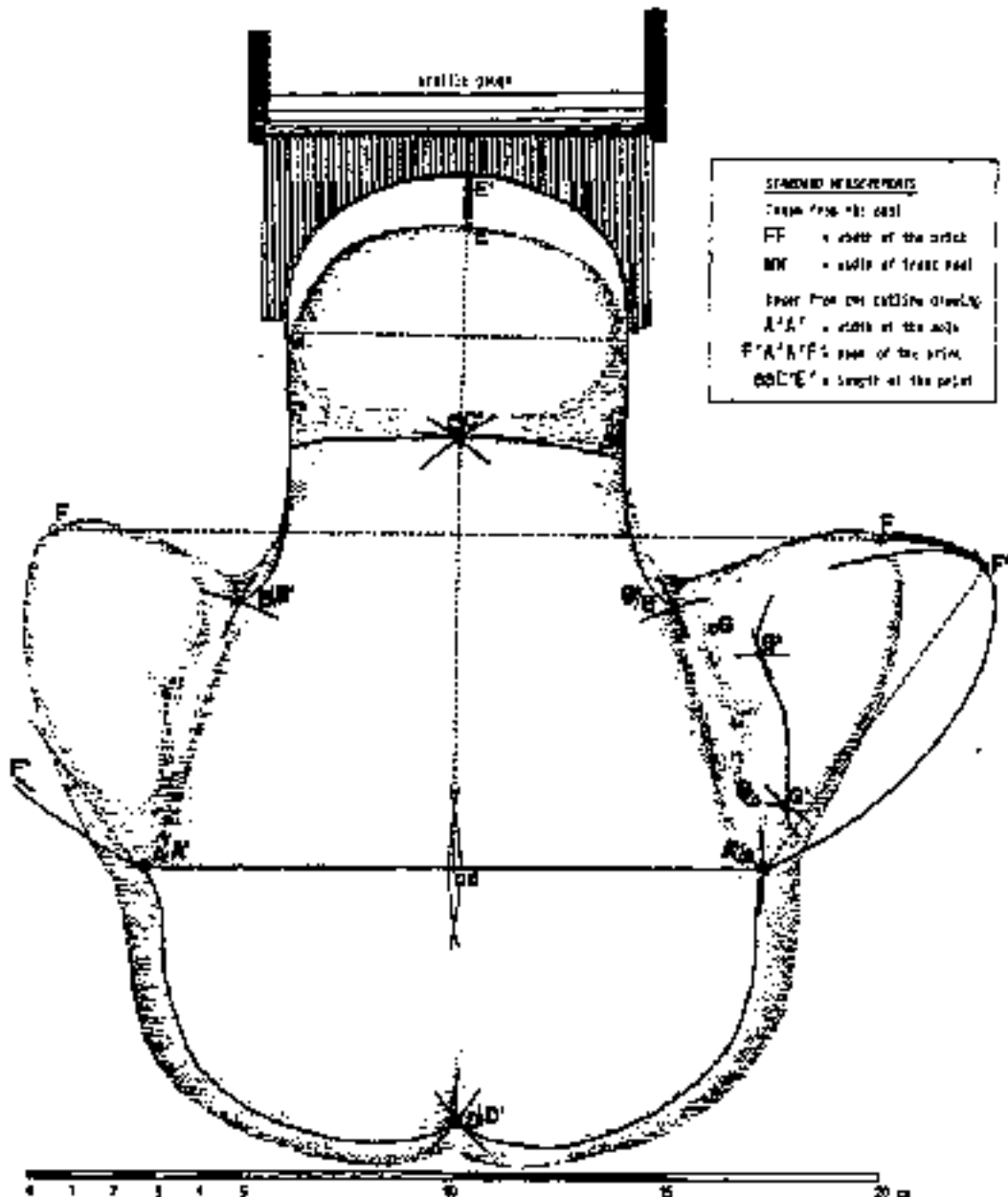

Figure 3.6 - The technique of making the outline drawings and taking the standard measurements of a plastercast. A drawing of a plastercast (no 45.7 L) with the measuring points A - G is superimposed on the outline drawing, constructed around the measuring points A' - G' . The position of the measuring points are taken over from the cast to the outline drawing with a drawing compass, and the profiles of the hoofs are made with a profile gauge. The complete procedure is described in chapters 3.3.2 and 3.3.3

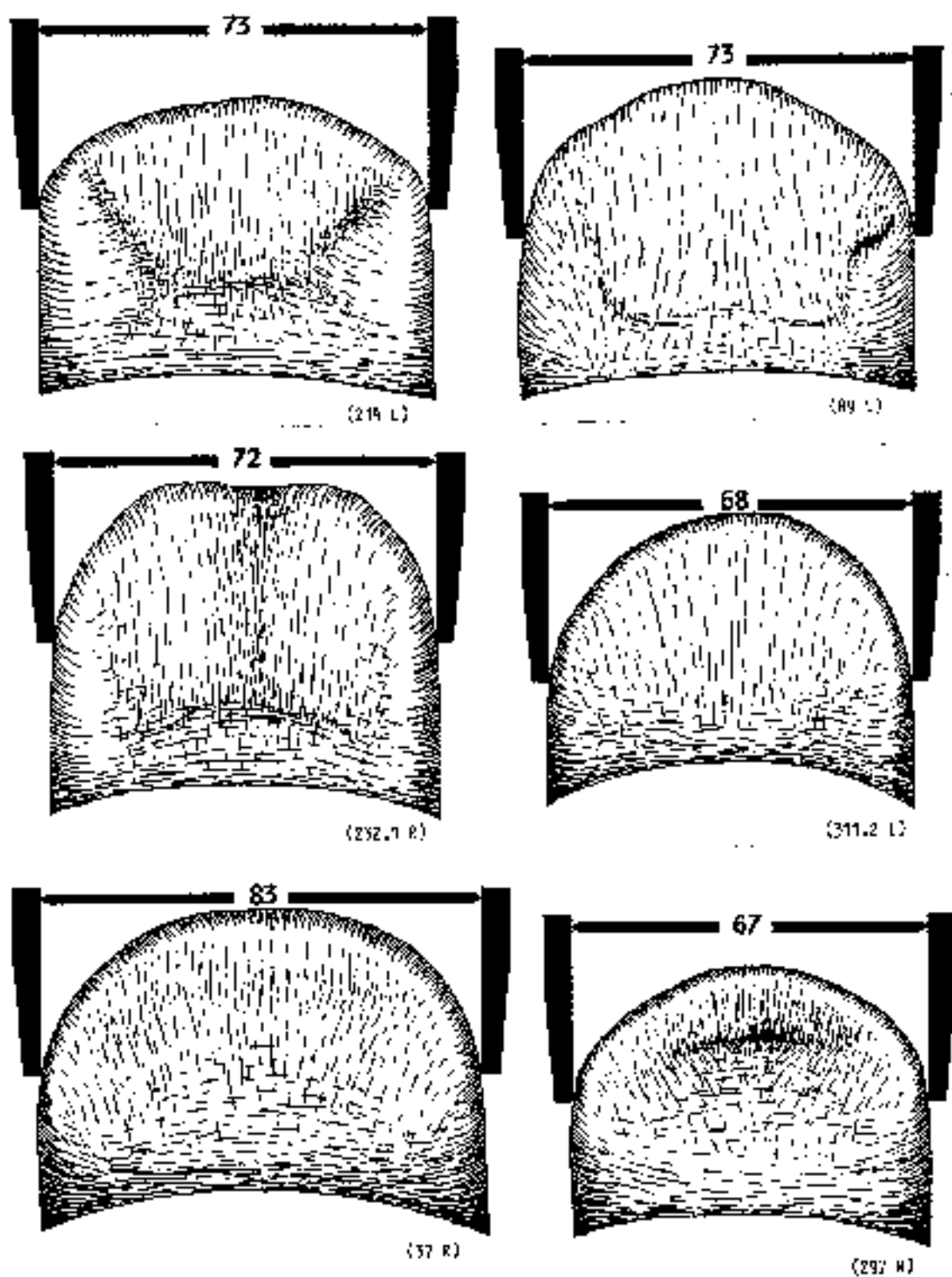

Figure 3.7 - A selection of front hoofs of plastercasts to illustrate the points on the rim where the width of the front hoof is measured

3.4 - Procedure of the sorting and identification of the casts

From the very beginning of the study with plastercasts it was clear that there are characteristic differences between the prints of different tracks, and that prints from the same track are similar in appearance. Some prints, those which show special characteristics in the form of the foot or the hoofs, could be sorted out easily, and these were often already recognised from the print or the cast in the field and given names such as 'flatfoot', 'square', 'chickbase', 'sharp' etc. But the majority of the prints are all rather similar and more difficult to identify to individual rhinos. The casts from one expedition could generally be sorted to different individuals without too much difficulty, but it was much more difficult to decide on sets of casts from the same individual rhino found on different expeditions.

As soon as the first casts became available for further study, attempts were made to identify the different individual rhinos, and gradually the collection was extended. Gradually more insight was gained into the characteristics of the rhinos' feet and how these are expressed in a plastercast, influenced by external factors like soil, weather, position, mode of movement etc. Through lengthy comparisons of large numbers of casts it was learned which part of the physiognomy of each cast reflects the form of the foot and the hoofs, and what is only a deformation caused by external forces or the result of less perfect casting. Perfect prints and casts, showing all parts of the foot with the same detail and sharpness, are extremely rare, and most casts are somewhere deformed or have some parts obscured by objects such as leaves, twigs, stones, tree-roots etc.

Although working with a large number of plastercasts is cumbersome - they are heavy and take up a lot of space - there is no suitable alternative method for identifying casts. Much of the identification work can be done with the outline drawings, but in the end it was always necessary to go back to the casts themselves and compare them one by one, looking for important and often crucial characteristics that do not show in the drawings.

Because correct identification of the casts is vital for interpreting the rest of the study, much attention and time was given to this problem. After the end of the fieldwork the definitive sorting and identification of the casts took place in Bogor, a process that took almost two years or an estimated 2000 hours of part-time work. Casts were spread out on the floor or on special racks, so that they could be compared easily.

Plastercasts were arranged in sets, each set containing all the casts from one track and thus undoubtedly made by the same rhino. Sets with sufficient similarity throughout the study were placed into series, so that a series contains all sets made by the same rhino. Each series was given a three digit number that was recorded on the cast, on the outline drawing and in a logbook. A small number (47) of sets could not be assigned to a series or were of questionable identity, because the casts were incomplete or too bad to show distinctive characteristics.

The whole process of the sorting out and identification of the plastercast collection can be split into two main stages. During the first stage attention was mainly focussed on the sets, the complete collection was systematically reviewed and the outline drawings and standard measurements were made. The first preliminary series were formed, containing casts of a certain general type rather than casts made by one particular rhino. As more sets of casts were examined, the series were further split up. At the end of the first stage, when all measurements and drawings were made, it was clear that the system of series was still far from perfect. Consequently the second stage concentrated on further comparisons until all good sets of casts were assigned to homogeneous and distinct series.

In the first stage of the sorting process the whole plastercast collection was systematically examined three times. The first time all casts from one expedition were laid out set by set, and from each set the best casts were drawn in outline. The second time each preliminary series was laid out, set by set, and the remaining outline drawings were made. More comparisons of casts and drawings were made and the series were further split up in a first attempt to identify individual rhinos. From each series the three best prints of left and right foot were set apart for comparison with other series. These best series were placed on special standing racks for easy reference. The third time the standard measurements were taken from each cast and further modifications were made to the series. This time also other factors, like the place and the time of finding were taken in account. Once casts had been associated to series (belonging to individual rhinos) it was possible to make preliminary distribution maps, showing the movements of individual rhinos.

Initially it was estimated from previous rhino surveys (Kurt, 1970; Borner, 1979), that no more than about ten rhinos would live in an area the size of the upper Mamas. New series were created only reluctantly, but soon there were more than ten series and it became clear that, although the sorting and identification was far from completed, that there were considerably more rhinos in the study area than was previously thought and the number of different small tracks indicated that several births had occurred during the study.

In the second stage the series were checked for homogeneity within the series, and they were compared with other series. Whenever a set was removed from one series to another the complete series were reviewed again, and most series have been scrutinised many times. Careful examination was made of the cow and calf pairs, to find out which sets formed the continuation of the series after the cow and calf had separated.

At one time there seemed to be more than 60 series (apparently representing 60 different individuals) but closer examination revealed that some series were very similar and occurred in the same area, and others seemed to replace one another in the course of time. After close examination several series could be combined, because the differences could be explained by differences in soil condition or position of the foot, or by gradual changes of the shape of the hoofs, and the total number of series was reduced to 39.

When sets or series of casts were compared, the procedure aimed primarily at checking the casts for similarity, that is to show that the casts could have been made from prints of the same pair of feet. When the differences were such that the casts could not have been made by the same feet, the consistent distinctive characters were sought. The main criteria used to show similarity were those of dimension and form. The dimensions show most clearly in the outline drawings, that were compared by overlaying them on a light table. Form was further compared by laying the casts side by side. The standard measurements were not used, because they show a large individual variation (see chapter 10) and are, in essence, also incorporated in the outline drawings.

The overlayed outline drawings were checked for a "good fit", not only of the whole outline but also for the form of the plantar surfaces of the hoofs. The outline of the foot was considered to have a good fit if the lines followed the same curve, deviating not more than a few millimetres to either side, especially along the hoofs. The variation on the soft parts of the foot, between the hoofs and the heel part are of course much wider. Because the hoofs are not fixed on the foot, moderate shifts in position of one or more of the hoofs was allowed. The front hoof might be shifted to the left or right and the side hoofs can be rotated for 5 or 6 centimetres around the centre of the foot and can also be shifted one or two centimetres in- or outward (see the figures 3.19 and 3.20, showing outline drawings that were considered to have a good fit). These variations in the position of the hoofs are mainly caused by soil type and the animal's movement (see chapter 3.5.2 and 3.5.3). By moving the sheets of outline drawings on top of one another one can see fairly easily whether differences in position are within reasonable limits or not. Especially on the sharp posterior edge and around the tips of the hoofs, the lines should not deviate more than one or two millimetres and only for part of the curve, in good casts.

When the outline drawings of casts were considered to have a good fit their condition was reviewed to see if the casts were of comparable quality and made under comparable conditions. If there was no good fit, the casts were checked to see if this could have been caused by imperfections or deformations in the casts. The form of the sole and the hoofs, and the position of the hoofs are important criteria, as well as minor features like the development of the basal ledges and the curvature of the plantar surface.

When comparing outline drawings or casts, the condition of the casts is of prime importance, to judge whether differences reflect real differences in the foot that made the print or are caused by external factors such as soil condition. The variation in size between casts from the same track can be considerable and many aspects of the form of the foot can only be seen in some of the casts. Whether a difference in size or form of the cast is significant will depend very much on the quality of the plastercast. For example a difference of only 2 mm in the width of the front hoof might be significant when the casts are very good and sharp, but with less good casts tracks from the same animal might vary by as much as 10 mm.

Therefore one can never rely on just one characteristic, but must consider all aspects of dimension and form before deciding whether or not the casts could have been made by the same pair of feet, i.e. by the same rhino. Here experience helps with judgement. Sorting and identification of plastercasts is a slow and exacting process with some casts identified easily and others allocated to a series only after long and continuous examination.

When sets were recognised to be similar they were allocated to the same series. If a set of casts was found to be different from the rest of the series, it was removed from the series and checked against other series. Series were continuously re-assessed and several times other evidence indicated that one series contained tracks of two animals. For example, in a certain period tracks of this series were found with a calf, while other tracks without a calf were found, or tracks were found at widely separated locations at about the same time. Circumstances like this proved that certain sets could not be from the same animal and that the series should be split, even though the tracks were similar. Morphological differences alone were sometimes insufficient to justify splitting a series. Sometimes as better casts became available minor differences were detected between sets and a series was split.

The process of sorting and identification came to an end when further comparisons failed to reveal more aberrant sets or series that should be split or merged. All aspects had been considered and weighed carefully and repeatedly. All good sets were placed in series that showed

good homogeneity or reasonable modification with age, and were unambiguously distinct from one another. At the end of the process it were always the same sets, mostly incomplete and made from very old tracks, that posed problems in the identification. During the last review, when all series were laid out and compared for the last time, a decision was made concerning all doubtful cases and from that moment on the identification was not changed anymore.

In total 39 different series, representing tracks of 39 individual rhinos, were represented in the plaster collection and from these records information was obtained on distribution and ecology of the Sumatran rhino as described in chapters 4 to 8. It is impossible to describe all sets of casts with reasons for the identification, but in the next chapters the formation of one exemplary series will be described in detail and its characteristics will be compared with a number of other series.

In chapter 3.9 some recommendations will be given for future studies in which plastercast identification may be attempted.

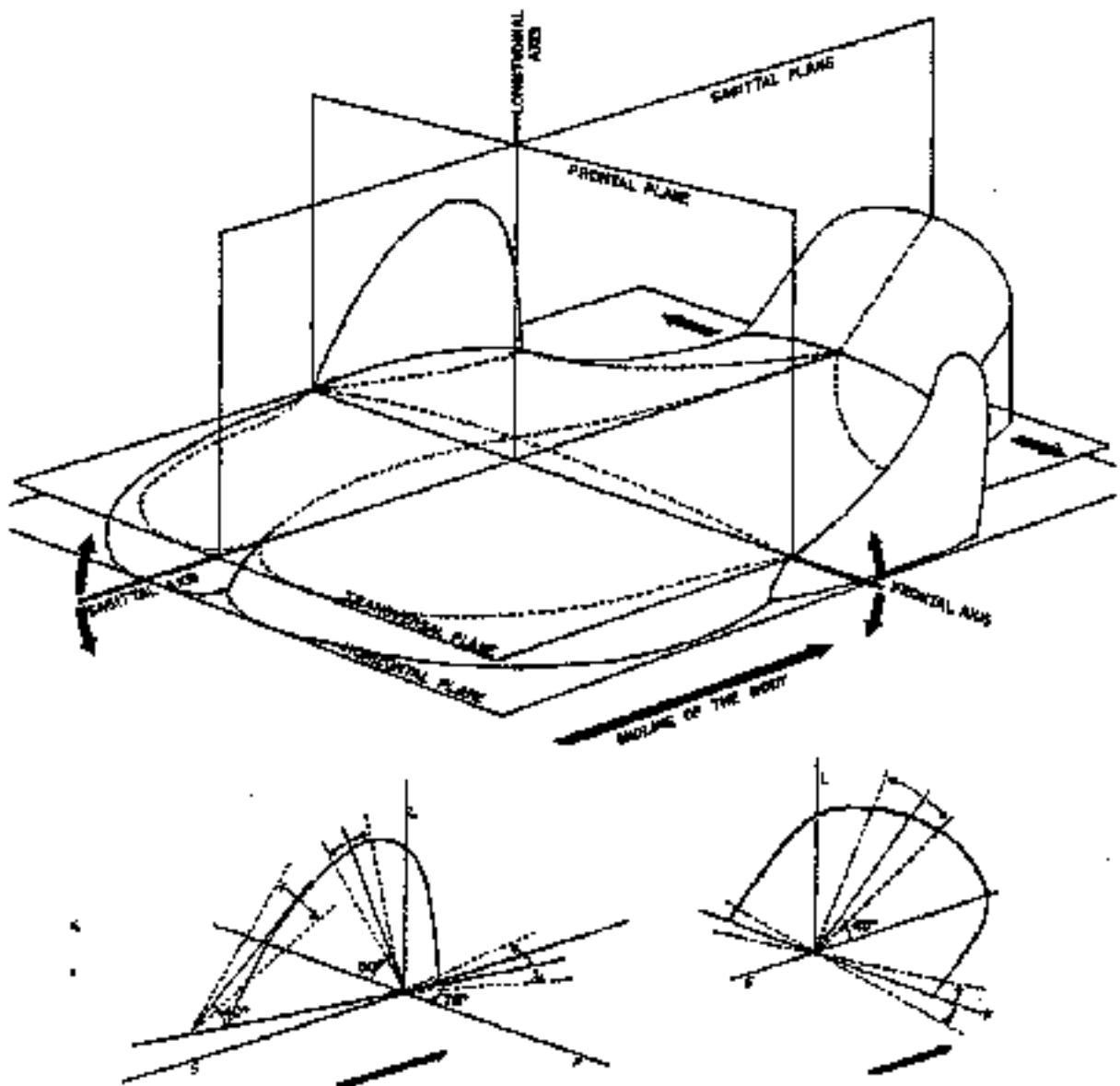

Figure 3.6 - Stereographic model of a foot and hoofs, illustrating the planes and axes that can be used to describe the form of the foot and showing the usual or normal positions of the sole and hoofs

3.5 - Characteristics and variability shown in the casts

3.5.1 - General characteristics

In this chapter the various characteristics of size, shape and position of the foot and the hoofs, as visible in the casts, will be described. Some of the different forms and postures are illustrated with stereophotographs and drawings of example casts. Since no previous study had attempted to identify individual animals from plastercasts it was very much a question of trial and error to develop a suitable technique for comparing casts taken at different times and on different soils and places. The technique of comparison and the importance of the various characteristics of the casts were learned during the sorting of the casts and therefore the sorting procedure has been explained first.

Size is an important characteristic and in the tracks in the field one can easily distinguish four to five size classes, besides the very small prints of calves. This is about as much as can be distinguished by measuring the width of the print. The casts themselves could easily be separated into size classes. Later the size and dimensions of the casts were used by comparing the outline drawings (see the previous chapter and chapters 3.6.1 and 3.6.2, where a whole series is discussed). Another aspect of size, the standard measurements, were not used to identify the casts, but only afterwards to evaluate their usefulness in compassing rhino.

The type of the soil and the movement of the animal affect the form and the size of the cast. Within one set the values of the standard measurements vary between the casts and within one series the variation is even larger. In figure 10.4 in chapter 10 the variability found in one set (49) and within the series (520) is shown graphically. The differences between the largest and the smallest values in one set may be as much as 10% (6 mm for the width of the front hoof, 39 mm for the span, 28 mm for the sole, etc.) and the variation in the whole series lies between 15% and 30%. For the comparison of individual casts these values are not very useful.

Figure 3.8 is a stereographic model of a typical cast and of typical hoofs in the most common or normal position, showing the planes and axes that can be used to describe its form. The arrows indicate deviations from the normal position. An abnormal position of the foot or hoofs in the cast can often be explained by the terrain or the movement of the animal, but in some series there are more consistent deviations in the position of the foot. In some the transversal plane is generally not parallel to the horizontal plane (the flat backside of the cast is the horizontal plane). In a few series the foot appears to be either more inclined towards the front hoof, with the fore part of the print being deeper, or towards the heel. In other series the foot shows an inclination towards one of the side hoofs or the front hoof is shifted sideways with respect to the sole and the side hoofs. These deviations from the normal position, probably caused by differences in gait or in the way the animal puts weight on the foot, are relatively rare and often of limited importance for the identification, because larger deformations can be caused by terrain or movement and mask the supposed asymmetry of the foot.

The print of the flexible sole of the foot is not very distinctive; its form is largely determined by the soil and the type of movement. The only useful characteristic is the ratio of length to width. Some prints have a rather long and narrow form (See the stereophotograph of cast 78.2 L (series 140) in figure 3.24), with a long narrow portion in front of the side hoofs; others are short and broad, with a short, somewhat tapering, front portion (See the stereophotographs of cast 38.1 L (series 840) in figure 3.24).

One of the most important characteristics of the foot is the position of the hoofs, with respect to one another and to the midline of the foot. This position is fairly constant, even when the foot is deformed. It is also one of the few characteristics generally visible in bad prints, and it is therefore of great importance for the identification of the less than perfect prints, that form a substantial part of the collection.

The front hoof generally makes an angle of about 45° with the transversal plane (See figure 3.8 and the stereophotographs of casts 49.7 L (series 520) in figure 3.9 and 38.1 L (series 840) in figure 3.24). But in some series this angle is considerably smaller (See the stereophotograph of cast 78.2 L (series 140) in figure 3.24), in others larger (See the stereophotographs of cast 71.3 R (series 196) in figure 3.24 and casts 26.3 L (series 440) and 200.2 L (series 440) in figure 3.14). In most series the midline of the front hoof is more or less in the sagittal plane, but in a few series the front hoof is tilted towards the side (See the stereophotograph of cast 58.3 R (series 296) in figure 3.25).

The side hoofs show more variation in position. In most series both side hoofs lie symmetrically on either side of the midline of the foot (See the stereophotographs of casts 276.3 R (series 192) in figure 3.25, set 49 (series 520) in figures 3.9, 3.12, 3.14, cast 38.1 L (series 840) and cast 78.2 L (series 140) in figure 3.24). In others there is clear asymmetry, with one hoof lying in a different position from the other (See the stereophotographs of casts 58.3 R (series 296) in figure 3.25, cast 71.3 R (series 196) in figure 3.24, cast 26.3 R (series 440) and cast

200.3 R (series 440) in figure 3.14). Sometimes there is also a difference between the right and the left foot.

The most common or normal position of the side hoof is shown in figure 3.8. The plantar surface of the hoof makes an angle of about 50° with the transversal plane, and an angle of about 75° with the frontal plane. The tangent line at the middle of the posterior rim makes an angle of about 40° with the transversal plane. The normal position of the side hoofs is best demonstrated in the stereophotograph of cast 276.3 R (series 192) in figure 3.25.

In some series the tangent of the posterior edge is smaller, and the side hoofs are pointing forward (See the stereophotographs of cast 27.2 R (series 700) in figure 3.25), in others it is larger and the hoofs are pointing sideward or upward (See the stereophotographs of casts 58.3 R (series 296) in figure 3.25 and cast 71.3 R (series 196) in figure 3.24). If the plantar surface makes a smaller angle with the transversal plane the prints are flat (See the stereophotographs of casts 38.1 L (series 840) in figure 3.24 and 259.1 L (series 610) in figure 3.26), if the angle is large the hoofs protrude more than usual from the plane of the sole (See the stereophotographs of the casts 58.3 R (series 296) in figure 3.25 and cast 71.3 R (series 196) in figure 3.24).

The most significant aspect of the position of the side hoofs is the angle with the frontal plane, because this angle is apparently fairly constant and under most circumstances clearly visible in the prints and casts. In the most common or normal position the plantar surface, in particular the tip half, makes an angle of about 75° with the frontal plane, which means that the plantar surfaces of both side hoofs converge slightly toward the front hoof (See the stereophotograph of cast 276.3 R (series 192) in figure 3.25). In some series the plantar surfaces of one or both of the hoofs converge more strongly (See the stereophotographs of casts 58.3 R (series 296) in figure 3.25 and cast 71.3 R (series 196) in figure 3.24), in other series the plantar surfaces of the side hoofs are almost parallel to each other or there can even be slight divergence toward the front hoof (See the stereophotographs of casts of set 49 in figures 3.9, 3.12, 3.14).

The form of the hoofs is very variable. Apart from size the front hoofs vary in the ratio between length and width, in the general outline of the nail, in the thickness of the rim, in the development of the basal ledge and the side lobes. Some show peculiarities like a point or notch in the middle of the rim, very thick side lobes, a hollow plantar surface or asymmetry. To illustrate the differences and the rate of variation encountered, a front hoof from each series is shown in appendix A.

The side hoofs show very much the same sort of differences, and drawings of a selection of these are also shown in appendix A. All drawings of the hoofs are to size and based on the outline drawings of the best casts from each series, with the structure of the plantar surface shaded. The drawings are idealised, and sometimes details were taken from other casts. Generally less detail is visible on one single cast.

No two casts are identical, not even those in the same set and made by the same foot. Even between two good casts of the same foot there are always some differences in size and shape and for sorting it is very important to know how the form can be influenced by external and internal factors. One should be able to see how the cast might have been deformed and to what degree the cast still reflects the original shape of the animal's foot. In the following chapters a general account will be given of the kind of differences that were noted due to environmental factors, e.g. soil condition, and the gradual changes in shape that can be attributed to growth and aging or other factors that influence the shape of the rhino's foot. Some characteristic series will be described in detail.

External factors that influence the shape of the print and the cast are the soil - texture, composition and moisture - and the type of movement of the animal - speed, slope, direction. Changes in shape take place in young animals through growth, but were also found in full-grown individuals, apparently caused by changes in balance between growth and wearing of the hoofs. Occasionally injuries to one of the hoofs caused changes in shape.

3.5.2 - Influence of the soil

Some remarks on the influence of the soil on the prints have already been made in the chapters on the selection and cleaning of the print (chapters 3.2.2 and 3.2.3). Here the effects will be described in more detail and illustrated with some characteristic examples from the collection.

All the best casts came from prints that were made in moist clayey soils, in places where there was no litter or stones. A fine example of such a cast is shown in figure 2.9 (Set 49, series 520). This is one of the most perfect casts ever made and it can be assumed that the form of the cast is a fairly precise copy of the foot of the rhino. Suitable soils with the right degree of plasticity were only found in certain places and the predominant soils in the

Figure 3.9 - Stereophotographs of three plastercasts made in different types of soil

A - An unidentifiable cast made in forest soil heavily mixed with plant remains. Soils of this type are common in the study area and good clear prints are rarely found there

B - A cast (series 195) made in sand along a riverbank. The roofs appear to be more massive and fine detail cannot be seen

C - A near perfect cast (series 520) made in fine moist clay. Soils with the right degree of plasticity and free of litter and stones are only found in particular places, for instance around wallows, softlicks and on the major trails

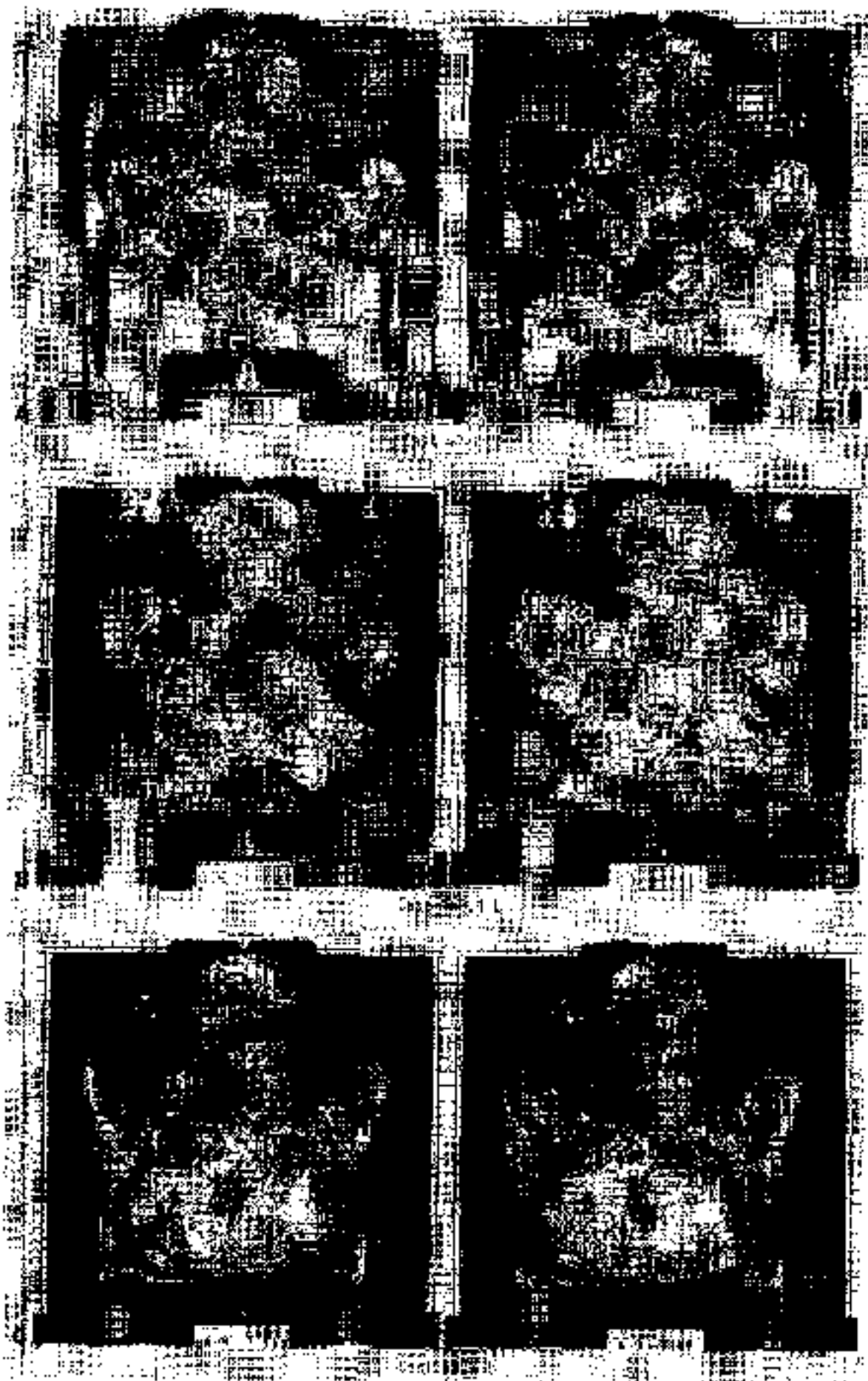

Figure 3.10 - Stereophotographs of three plastercasts of the same animal (series 460) made in soils with a different degree of firmness

A - A cast made in hard chalky soil near a saltlick. The print is very flat with the hoofs protruding little from the plane of the sole

B - A cast made in much softer soil. The hoofs are in the usual position. Whenever possible prints like this were selected for casting

C - A cast made from a very deep print in very soft soil. The hoofs project far from the plane of the sole and are in an unusual vertical position



Mamas were much less suitable for good and clear prints. These dark forest soils are superficially heavily mixed with plant humus and covered with a thin layer of dead leaves. They are generally crumbly and rather spongy and casts taken there show little detail; often also the form is blurred because of the nature of these soils. A typical example of a cast taken in such a soil is shown in figure 3.9 (set 47, unidentifiable). Casts of this quality were generally unidentifiable and were only made in desperation when better prints could not be found.

Prints left in the coarse sand by major rivers appear to be very good, because of the uniformity of the sand, but generally the casts turn out to be not very useful. The prints are difficult to clean without disturbing the print and the fine details do not show in the coarse sand. Because some sand is cemented to the plaster the hoofs appear to be much more massive on casts made in sand than on casts made in finer soils. A typical example of a cast made on a sandbank along the river is shown in figure 3.9 (Set 162, series 195).

The firmness of the soil plays an important role in the form of the print. The firmer or harder the soil the shallower the print and the more the hoofs are forced into the same plane with the sole. On really hard soils, like dried-out clay or saltcrusts round salticks only the tips of the hoofs are visible as short crescent-shaped imprints and the central part of the sole forms a shallow impression. These prints are useless for identification, because the base of the hoofs are not visible. The softer the soil the more vertically the hoofs are placed and the more they appear to project from the plane of the sole. In fairly firm soil the front hoof has its plantar surface in a close to horizontal position, and the forepart of the sole is flat. The softer the soil, the more the front hoof is placed in a vertical position, and ultimately virtually vertical. In very soft soils the forepart of the sole becomes strongly concave.

The influence of soil firmness is well demonstrated by the prints shown in figure 3.10 made from two sets found on the same expedition and assigned to the same series (sets 142 and 144, series 460). Cast 142.2 R was found in the hard chalky soil around one of the salticks, showing a very flat print, with the hoofs protruding little from the plane of the sole. The middle picture shows a cast - 144.2 R - of the foot in normal position, in moist and moderately soft soil. The third picture shows a cast - 144.4 L - of a print that was made in deep, wet and very soft soil. Here the hoofs are striking out very far from the plane of the sole and they are in an unusual vertical position.

In figure 3.11 the three outline drawings of the same casts are shown superimposed (The left foot reversed). Apart from the fact that the hard soil print is slightly narrower and longer, all three outlines are very similar, showing that the different positions of the hoofs are largely compensated for when outline drawings are made. In general the use of outline drawings allows for easier comparison of prints made under different soil conditions.

It will be clear that this can have a great influence on the dimensions of the cast, especially on the width of the print. Flynn & Abdullah (1983) reported that tracks made in soft, muddy soil were significantly larger than tracks made on firm ground, by as much as 2 to 4 mm. For the Indian rhino (*Rhinoceros indicus*) Laurie (1978) reported differences of up to 10 cm in the width of footprints of rhino tracked through wet and dry areas. However, measurements taken from the same animal's tracks made in hard and soft soil in the Mamas showed only very slight differences. This can probably be explained by the different ways of measuring in the two studies. Measuring the width of the print between the tips of the hoofs with a pair of callipers is likely to reduce the influence of the soil, except in extremely wet or dry soils.

Often one of the hoofs is forced into an unnatural position by a stone or tree root under the foot. Sometimes very peculiar prints are made, but it is generally obvious what has caused the deformation and these casts do not pose special problems in identification. Similarly overlapping imprints of fore and hindfoot can create front hoof casts that appear to be unusually wide to the casual observer.

The form of the hoofs as well as of the whole print is influenced by the firmness of the soil. In soft, wet soils, the hoof prints are considerably narrower and thinner, with a sharper edge. This is probably the result of a sucking action when the foot is lifted from the wet soil and collapse of the soil especially in very deep prints.

The reduction in size of prints in soft soils is most noticeable in the width of the front hoof, where the variation can be several millimetres. A good example is illustrated in figures 3.9c and 3.12a, showing stereophotographs of several casts from the same set. Cast 49.2 L (figure 3.12a) is a typical example of a print made in rather deep and soft soil, whereas cast 49.7 L (figure 3.9c) is made by the same foot in firmer soil. The hoofs of the cast in wet soft soil are slender and sharper than those from the firmer soil. In the outline drawings of these casts, shown in figure 3.13, the difference in width of the front hoof is apparent (almost 10 mm).

Because the width of the front hoof is one of the standard measurements, a simple experiment was carried out to demonstrate the influence of the soil on this parameter. A model of a front hoof was fashioned from wood, attached to a pole with a footstep. By standing on the footstep the hoof model could be pressed into the soil, and then lifted out with the pole, thus suggesting the walk of a rhino. Several series of imprints were made in suitable places, and casts made from the best imprints. After drying the casts were measured in the usual way.

The width of the artificial front hoof was 69.0 mm. The first series of casts was made in rather dry yellow clay, and the average width of the casts was 66.98 mm ($n=5$, s.d. 1.73). In a second series made in wet sandy clay the average width was 64.44 mm ($n=16$, s.d. 1.19). The last series was made in rather dry, hard sand and the average width was found to be 69.87 mm ($n=18$, s.d. 1.14). The lowest value in all three series was 61.2 mm, the largest was 73.2 mm.

Even prints made with an object of known size - the wooden hoof - vary considerably in width, variations which can be attributed to the character of the soil and probably also the animal's movements. The prints made in drier soils are fairly close in size (± 2 mm) to the original hoof, but the casts from soft soil are narrower - sometimes by 1 cm or more - than the original. Usually the surface of the cast shows the soiltype where it was made.

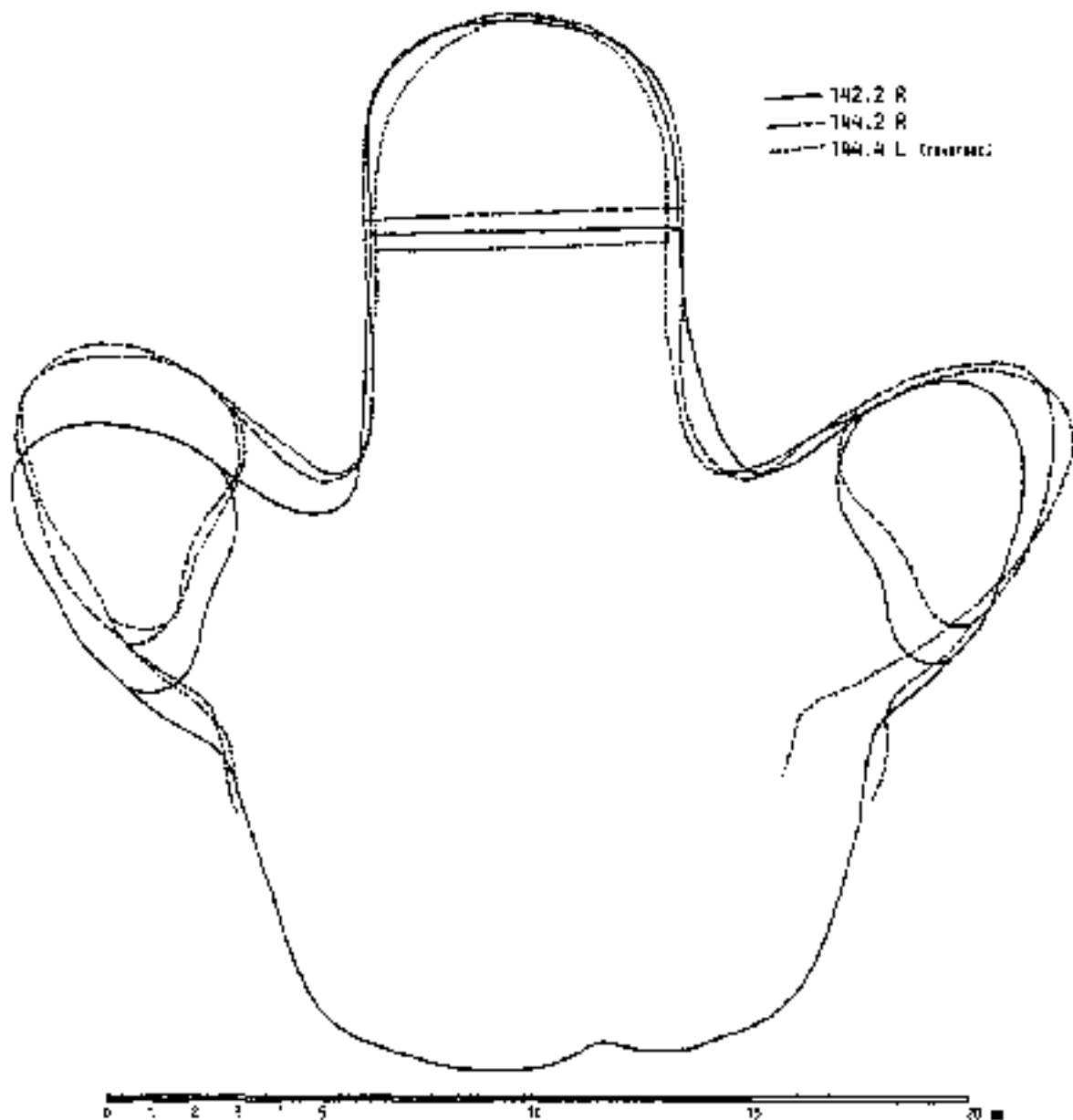

Figure 3.11 - The superimposed outline drawings of the same three cast shown in the stereophotographs in figure 3.10. The large differences in position of the hoofs seen in the casts show only little in the outline drawings. Differences caused by varying soil conditions are largely compensated for when making outline drawings, making comparison of prints more easy.

3.5.3 - Influence of the type of movement

The most important influence on the form of the print is that of slope of the terrain. There are clear differences in the position of the hoofs in relation to the slope. When a rhino is descending the side hoofs are spread outward and backward. When it ascends the side hoofs are much more vertical, much closer to the sole and more forward. The steeper the slope the more pronounced the effect is. Prints made on level or slightly sloping terrain are intermediate. Prints on ascending tracks are much narrower and prints on descending tracks are wider than those on level ground.

When a rhino changes direction in its walk the symmetry of the foot can be distorted with the front hoof shifted in the direction of the turn. Also the speed of walking influences the shape of the print. Most prints were taken from rhinos that apparently walked at leisure, but some were taken from animals that were running. In the latter case the hoofs are more than usual splayed and projecting, while the sole is flatter or even concave, probably due to greater pressure on the foot.

Good examples of the influence of soil and movement are found in set 49, series 520, stereophotographs of which are shown in figures 3.9c, 3.12 and 3.14a. Cast 49.7 (figure 3.9c), one of the most perfect casts ever found, was made in very fine plastic clay. Cast 49.3 L (figure 3.12b) is a good cast, but made in softer soil, showing the more pronounced profiles. Cast 49.2 L (figure 3.12a) was made in very soft soil, and shows the protruding hoofs and the slender and sharp rimmed appearance of casts taken from too soft soils. The front hoof is also considerably narrower than in the other prints. Cast 49.5 L (figure 3.12c) was made in rather firm soil, but on an ascending track. The shortening and narrowing of the print during climbing is obvious. Cast 49.6 R (figure 3.14a) was made in firm soil, but on a left bend of the trail.

In figure 3.13 the outline drawings of these casts are shown. The differences between 49.7, from firm clay, and 49.3, from the softer soil, are slight, with only a shift in position of the hoofs probably due to a meandering walk. The cast from very soft soil (49.2) is slightly wider with narrower hoofs. Twisting caused by turning (49.6, in reverse), and the compression caused by climbing (49.5), are also reflected in the outline drawings.

The type of movement influences the print width. Flynn & Abdullah (1983) analysed several series of print width measurements made under different conditions. In a track series of animals walking uphill the width measurement distributions tended to be skewed to the right, and when walking downhill the distributions tended to be skewed to the left. Similar results were shown by a series of print width measurements made during this study. Some examples are shown in table 1 below. For each series the measurements were made on different parts of the same track.

Table 1: Influence of slope on the width of rhino footprints. (sizes in mm)

		number	mean	standard deviation
series 168	descending	9	222.6	4.4
	horizontal	12	221.7	10.7
	ascending	18	182.7	5.3
series 520	descending	5	217	7.4
	slightly asc.	18	207	10.5
	strongly asc.	10	189.6	13.4
series 196	descending	10	219.3	4.9
	slightly asc.	5	203.6	10.0
	strongly asc.	10	196.1	10.0

Descending tracks are slightly wider than horizontal or ascending tracks on a slight slope, and climbing tracks are considerably narrower. This is clearly visible, also in the field, and is explained by the varying burden on the hoofs, that forces them apart in descent and into a more forward and inward position for ascent. For track measurements one should therefore select level or gently sloping terrain if possible. For choice no tracks should be casted or measured on slopes steeper than about 10 degrees.

Figure 3.12 - Stereophotographs of three plastercasts of the same animal, showing differences in size and shape attributable to differences in soil and movement. The stereophotographs in the figures 3.9c and 3.14c are part of this series (Series 520).

A - A cast made in very soft soil, showing the typical form with outstanding hoofs that are narrow and sharp-edged. The profiles of the hoofs are often unreliable in these casts

B - A cast made in soft soil, showing a pronounced or sharp profile, but to a lesser extent than in the photograph above. This is a good casts showing most characteristics

C - A cast made in rather firm soil from a print in an ascending track. The shortening and narrowing of the foot while climbing is clearly visible



Camp 49, L



Camp 49, L

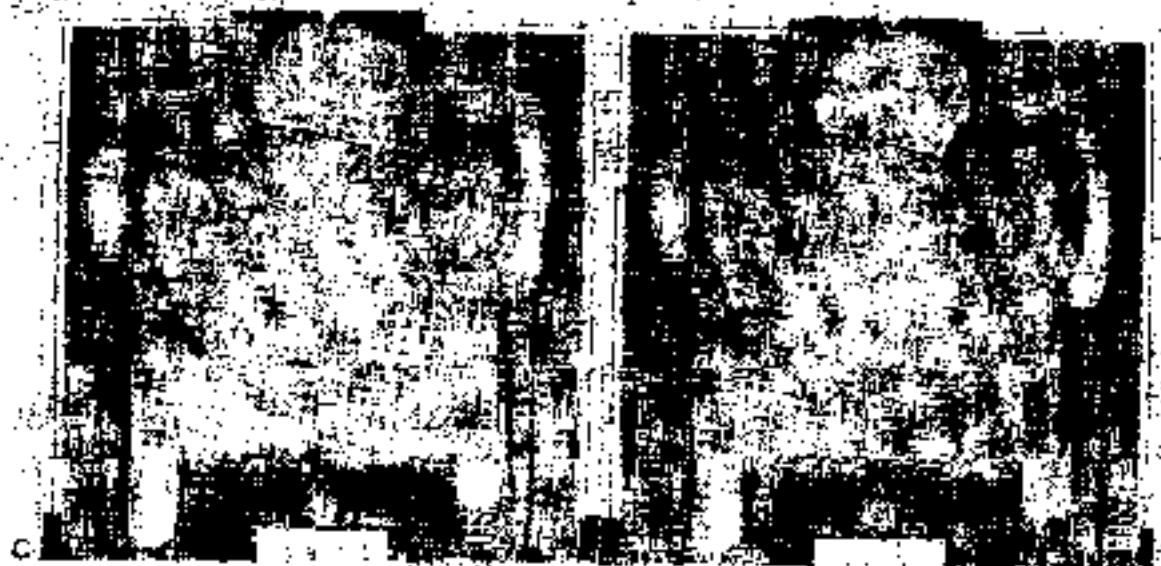

Camp 49, L

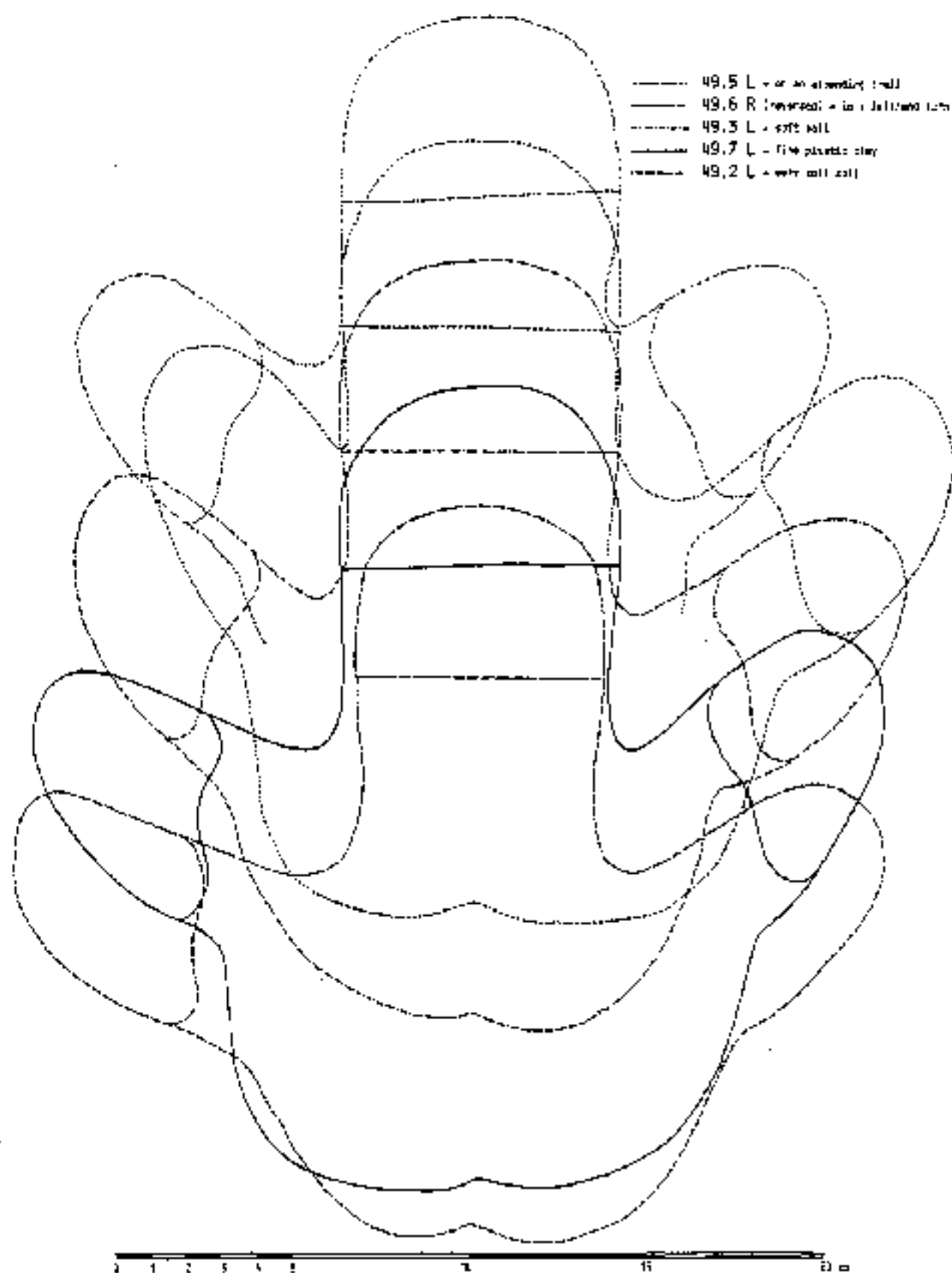

Figure 3.13 - The outline drawings of the same casts shown in the stereophotographs of figure 3.9c, 3.12 and 3.14c. All casts are from the same track, showing differences caused by soil and movement. The differences between the lower three profiles, made in soils of varying plasticity are slight, the one made in very soft soil (49.2) is slightly wider with narrower hooves. The torsion because of the turn in the trail (49.6) and the compression of the foot while climbing (49.3) are clearly visible in the outline drawings too.

3.5.4 - Gradual changes in size and shape

The changes in size and shape of the footprint of the growing calf are discussed in chapter 4.1. Here the changes that were observed in the footprints of full-grown rhinos will be analysed. From the beginning it was anticipated that certain changes might occur. The form of the hoof is the result of its growth and the rate of wearing down through contact with the ground. When both counteracting forces are constant the resulting shape of the hoof will also be constant, but when they are not constant, changes in shape can be expected. The growth of the hoof will be influenced by the condition of the animal, and wear will be influenced by ground conditions and by the activity pattern of the rhino. Although it was expected that the shape of the foot of full-grown rhinos would remain essentially the same over the relatively short period of the study, changes in certain aspects of the print were anticipated and during the final sorting it became obvious that this was so.

Such changes are best illustrated in series 440, one of the females that nursed a calf in the northern corner of the study area. From this rhino several complete sets, with generally good casts, were available and identification was aided by the presence of a calf from the 7th till the 10th expedition. Two sets, that undoubtedly belonged to this series, were found from before the calf was born. All material until the 10th expedition was very uniform and showed several typical features, establishing the animal's identity beyond doubt. But initially it seemed we had no casts from this female after the 11th expedition, when her infant had become independent. Good rhino prints were found later in the same area, virtually on the same trail leading north from the saltlick at camp Uning, but they seemed sufficiently different to be classified as another rhino.

Closer examination revealed that there were real differences (the casts were of such quality that the differences could not be explained otherwise), but that they were caused by only one parameter, the length and form of the side hoofs. In all other aspects (overall size, front hoof, the rather peculiar position of the side hoofs) they were identical and it seemed likely that they were made by the same female, but that the length and form of the side hoofs had changed over the course of time. When the shape of the side hoofs in the older sets was studied more carefully, it was found that the length of the hoofs showed a gradual reduction in length from one expedition to the next and the later series was merely a continuation of this process. It was therefore concluded that the earlier and the later sets were made by the same rhinoceros, and both series were merged.

In figure 3.15 the outlines of the best side hoofs from each set are pictured. The left foot prints were chosen because they form a more complete sequence of good casts. It is clear from the figure that the lateral hoof shows marked changes in shape, while the median hoof remains more or less constant. In the earliest sets the lateral hoof is long and has a very wide tip, becoming more triangular on the 9th and 10th expedition and shorter and broader in the later expeditions. It appears that it becomes more rounded again in the 16th expedition. In figures 3.14b and 3.14c a stereophotograph of an early print of series 440 (26.3 L, expedition 4), and one of the later casts of this series (200.2 L, expedition 13) are shown.

Series 440 is by far the best documented series in which an apparent change in shape has taken place, but it was also found in other series. In series 158 a very large change in the length of the side hoofs was found, in the lateral as well as the median hoof. A similar effect was noted in series 296, but only in one hoof. Prints belonging to both series were only found at long intervals. Some of the sequences of side hoof profiles are shown in figure 3.16. All show an extreme shortening in the length of the hoofs. In the right foot of series 158 the tip of the lateral hoof has apparently broken off. This is also visible on the other casts of this set. Most of these casts were kept in separate series until good proof of the occurrence of changes in size in side hoofs was found in series 440. Then these other casts were also re-examined and several problems of identification could be cleared up.

Injuries to the hoof were found relatively seldom. In series 155 the left foot shows a notch in the posterior rim of both the side hoofs from the 10th expedition. In subsequent expeditions this developed into a straight or slightly hollow section in the edge, but on the 16th expedition the edge again showed the usual curve. Sequences of profiles of series 155 are shown in figure 3.17. Similar notches were seen in some of the hoofs from the Bogor Museum. One of the calves had a large chunk, the median quarter, of the front hoof broken off when it was about 6 months old. On the next expedition, about three months later, this injury was still faintly visible as a flattened off part of the rim, but two months later the front hoof had a normal rounded profile.

For comparison in figure 3.17 (lower row) an arrangement of side hoof profiles of all the casts of set 49 is included, demonstrating once more the variability in casts from the same hoof. All lateral hoofs, of both left and right foot, are pictured (Those of the right foot are reversed for comparison). The curve of the edge is very similar in most drawings, except for the lower part of the hoof. The base of the hoof is usually less well preserved in the print, and this part is more flexible. The chin edge of the hoof is usually fairly constant, but the basal part

varies in curve and length. In cast 49.2 the basal ledge appears to be much higher, but that is probably an error, because the ledge is hardly visible in the cast (See figure 3.12a). Also the profiles of 49.1 and 49.4 are different. Cast 49.1 has a little point near the tip and 49.4 is longer and more forwardly curved. Both aberrations are caused by a forward drag of the foot from the place of rest. This is fairly common and the hoofs cut a furrow in the soil, that is also filled with plaster during the casting. The tip and the anterior edge of the side hoofs are then often not clearly visible, causing aberrations in the outline drawings as demonstrated here.

Because substantial changes in shape of the side hoofs are apparently not unusual, sequences of side hoof profiles were also made for some of the better series that did not show clear changes. Two of these are shown in figure 3.18 (series 520 and 610). Series 520 was found to show a slight shortening of the side hoofs, and at one stage of the sorting process this led to the splitting up of this series (see chapter 3.6.1). In series 610 no change in length can be detected, but it appears that the profile is more triangular in the older casts and more rounded in the later sets.

A few of the outlines do not fit very well in the series. In series 520 cast 66.3 is longer and cast 120 shorter than the rest. Both are cast from old tracks, cast 66.3 made in rather moist soil and the tip of the hoof is not very well preserved. Cast 120 was made in hard soil and required much cleaning and restoration before the casting, and the tip of the hoof was probably not cleaned out sufficiently. In series 610 cast 79.1 is longer with a broader tip, but this hoof is a double print with parts of the print of the forefoot also preserved and it is difficult to see where the tip of the hindfoot hoof should be located.

It seems that large changes take place only in the side hoofs of some of the individuals. In no series was a notable change observed in the size or shape of the front hoof. It also appears that changes in shape of side hoofs are more common in females than males, and were never seen in the tracks of young or sub-adults. Such changes might be related to pregnancy, because both series 440 (figure 3.15) and 158 (figure 3.16) have the longest hoofs before birth or when the calf is still young and much shorter hoofs by the time the young is independent and in series 440 it seems that the hoofs are again a little longer later. The females have different ranges when they are with a calf and probably their activity pattern is also different then (see chapter 5.1.1); this could shift the balance between growth and wear of the hoofs.

The climate probably also plays an important role in the trends in hoof shape described above. It is well-known that the growth and resiliency of the horse's hoof is greatly influenced by moisture. In a moist climate, when the ground is soft and muddy, the hoofs appear to grow more rapidly, but they also become weaker, more pliable and less elastic than normal, and they tend to lose their most efficient shape. The moisture causes the horn tubules to loosen and the hoof is subject to injury. Also the type of food available to the horse is known to influence the quality of the horn and thus the shape of the hoofs (Emery, Miller & Van Hoesen, 1977).

The amount of rainfall and the duration of the dry periods varies considerably from year to year in the Gunung Leuser area. In some years the soil will probably never dry out, in others the soil can be dry and hard for a few months at a time. The very long side hoofs were only found in the first half of the study, but since detailed weather records are not available, no correlation can be made. In the first half of the study there was certainly more rain during the expeditions than in the second half, but that could be coincidence. Rainfall in Kotambe was fairly high in 1974 (c.a. 3450 mm) and 1975 (3591 mm, 221 rain days), about average in 1976 (3260 mm, 211 rain days), 1977 (3199 mm, 212 rain days) and 1978 (3126 mm, 193 rain days) and low in 1979 (1980 mm, 206 days). It could be that the occurrence of excessively long side hoofs is caused by a prolonged period of uninterrupted wet soil conditions in 1974 and 1975.

Figure 3.7^a - Stereophotographs of plastercasts

A - A cast made on a left bend of the trail, showing distortion of the foot. This is a rather exceptional cast, normally torsion is much less obvious (Series 520)

B - A cast of an early print of series 440, showing long and slender broad-tipped side hoofs. Compare with the photograph below

C - A cast of a later print of the same series 440, with much shorter triangular hoofs. Compare with the figure above. From the period in between a series of casts is available, showing a gradual change from the long and slender hoofs to the shorter triangular type (see figure 3.15)



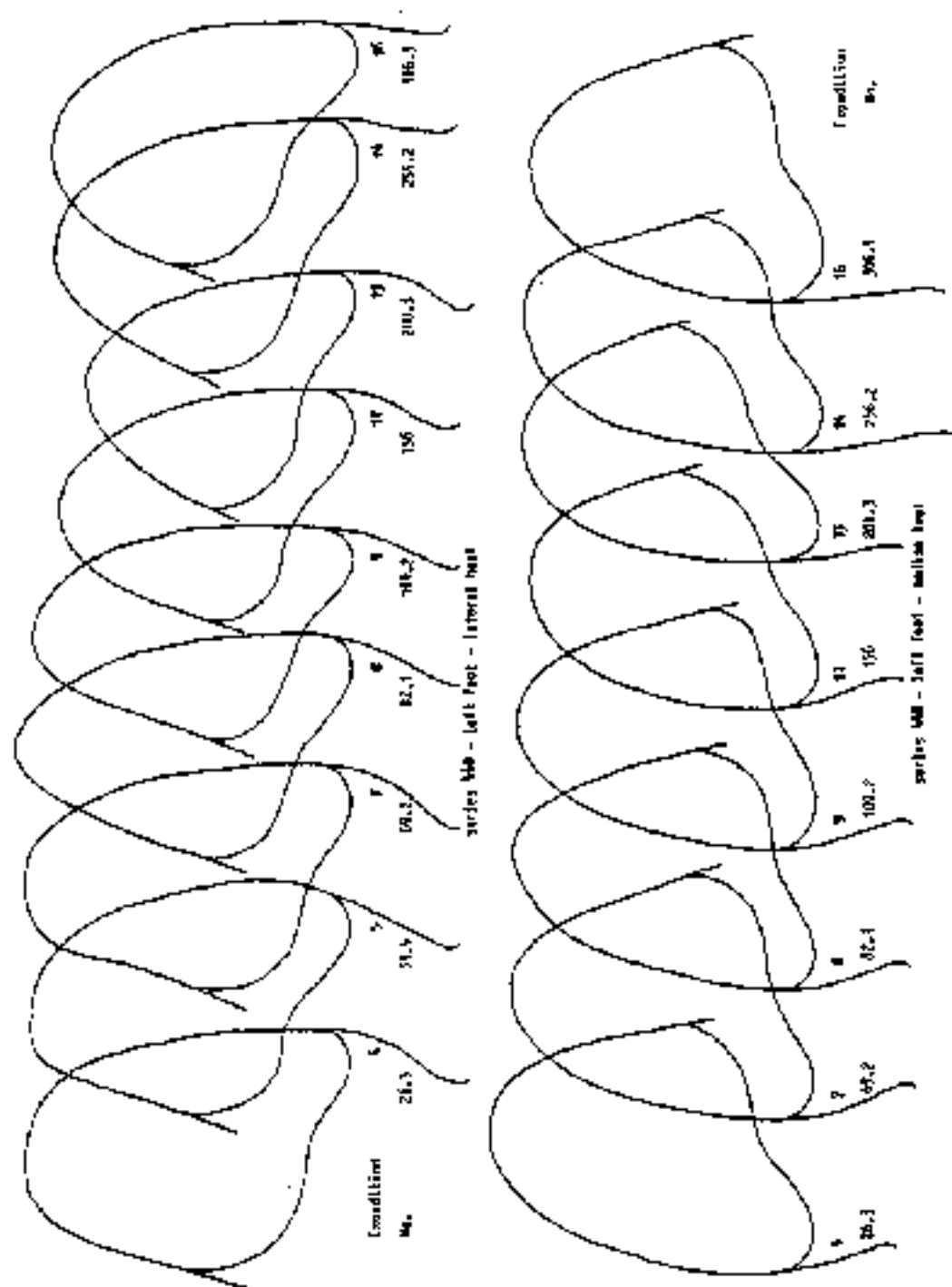

Figure 3.15 - Chronological series of side hoof profiles of the left foot casts of series 800. All median hoof profiles are very similar, but the lateral hoof shows a marked change in shape, from long broad-tipped to short triangular and later again somewhat longer, in all other aspects the casts are identical and were certainly made by the same animal. Stereophotographs of the casts 26.3 and 200.2 are shown in figure 3.14

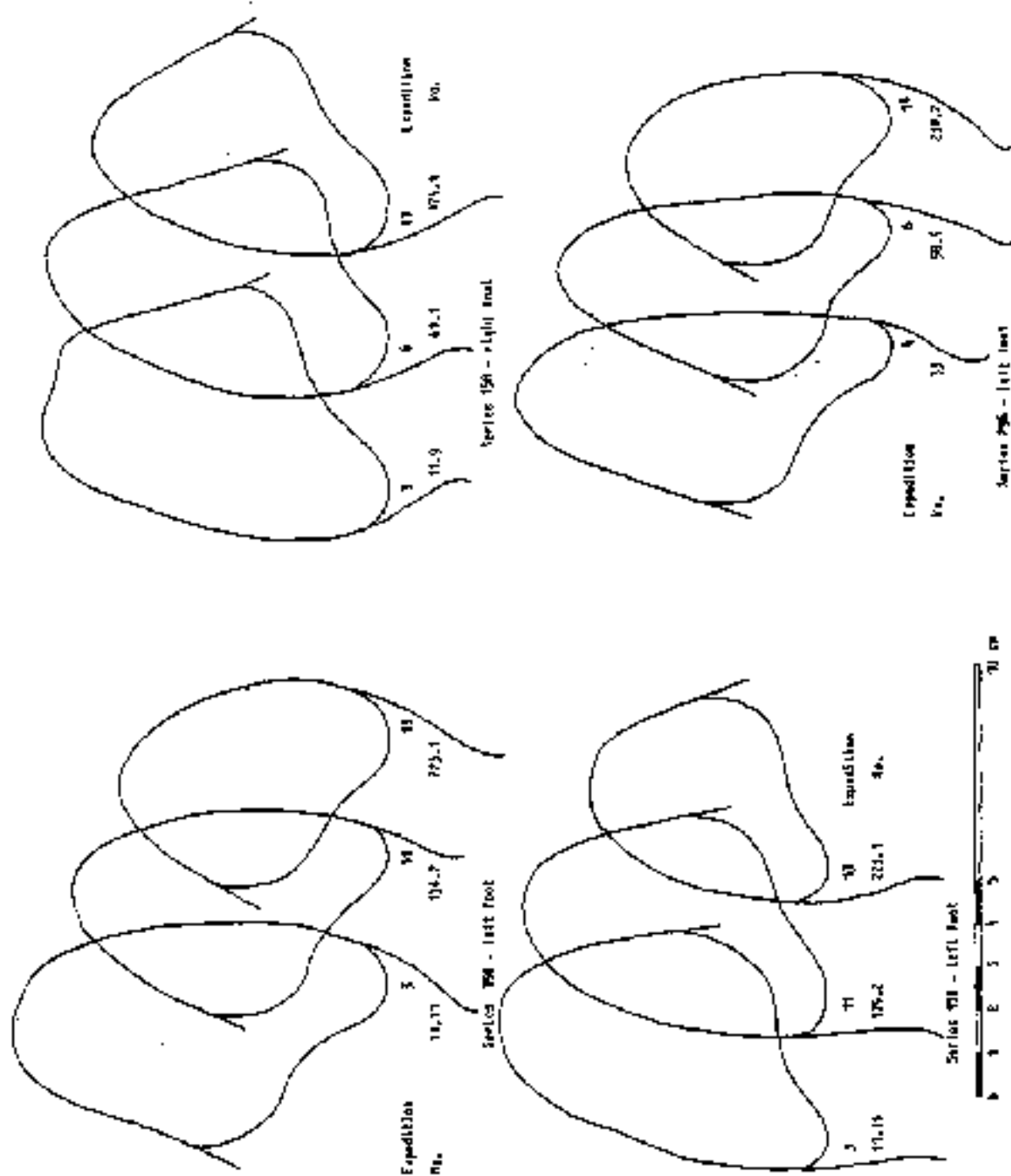

Figure 3.16 - Chronological series of side hoof profiles showing extreme changes in shape with time. In series 158 the shortening of the side hoofs occurred in all hoofs, in series 255 only in the lateral hoof of the left foot. The tip of the lateral hoof of the right foot of series 158 has apparently broken off shortly before the third expedition.

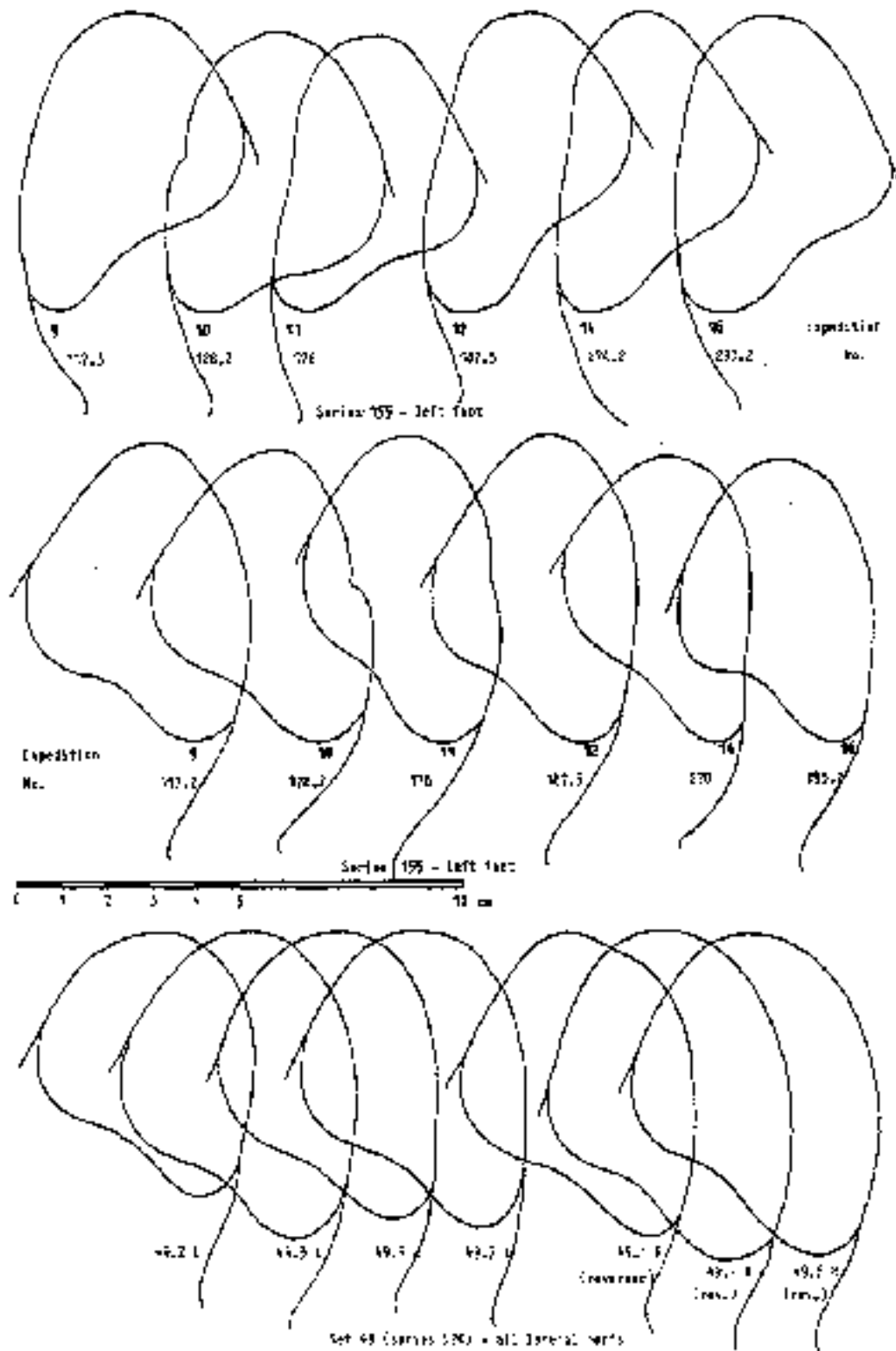

Figure 3.17 - Chronological series of side hoof profiles of series 155, showing a change in shape caused by an injury to the hoofs. A conspicuous notch is visible in the rim of both side hoofs of the left foot during the tenth expedition. In subsequent expeditions it is gradually worn away. The lower row shows all lateral hoof profiles of set 45 for comparison. All casts were made of one track, demonstrating the variability of the profiles in casts made of the same foot. Stereophotographs of most of these casts are shown in figures 3.9c, 3.12 and 3.14a. The major differences between the profiles can be explained by imperfections in the casts

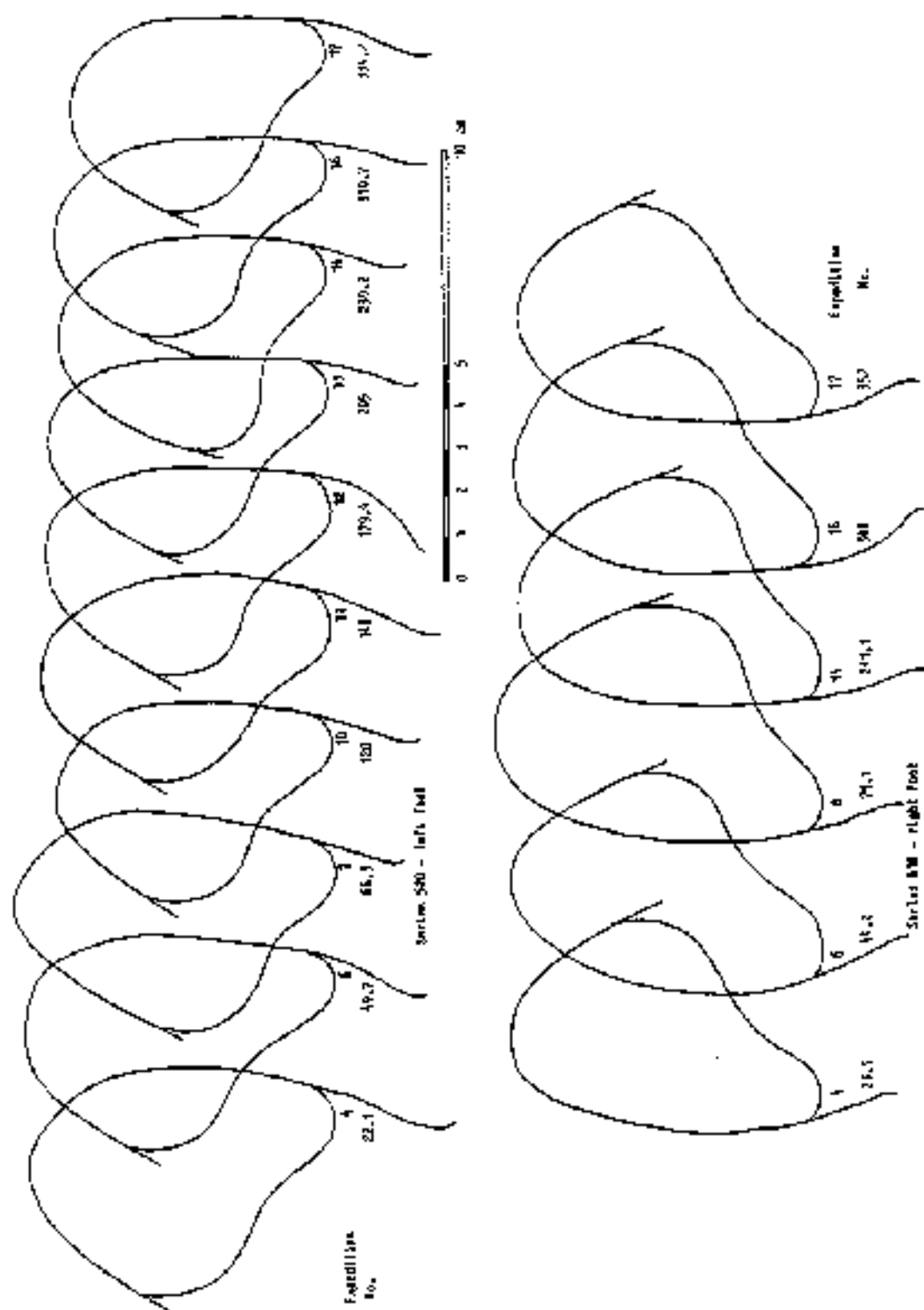

Figure 3.18 - Chronological series of side hoof profiles of two series that did not show a large change in shape. In series 520 there appears to be a slight shortening of the hoofs (This led initially to a splitting of this series - see chapter 3.6.1), and in series 610 the hoof appears to be more triangular in the earlier and more rounded in the later casts. The few gerront profiles are caused by imperfections in the casts

3.6 - An illustrative example

3.6.1 - Formation of an exemplary series

Some aspects of what has been written in the previous pages will be illustrated here with a description of the process of formation of one series. The selected series - 520 - is one of the largest and most complete series available. A number of stereophotographs of casts from this series are used for illustration in the previous chapters. In this and the following chapter the formation of this model series is described and compared with several other series, to illustrate the nature of the differences.

Rhino 520 has been found on all expeditions, with the exception of the 3rd and 5th, in the area east of Camp Aceh. The animal's footprints were called "square" because of the squarish form of the foot and the front hoof (see the stereophotographs of set 49 in figures 3.9c, 3.12, 3.14a) and already in the early stages of the study these casts were recognised as being distinct and probably made by one and the same rhino. They were often recognisable in the field, mainly because of the parallel or even slightly diverging position of the side hoofs, a comparatively rare phenomenon. The casts were easily picked out during the preselection and during the sorting process this series has been laid out many times for comparison with other series or to check the homogeneity of the series. Because this series is so well represented in the collection and tracks were often found in different places during one expedition, the possibility of more than one rhino with similar prints could not be ruled out. Therefore this series was scrutinized for slight differences between the sets that would justify the separation into two or more different series.

The only differences that could be found were slight differences in the position and the length of the side hoofs, and in the width of the front hoof. Based on these differences at one stage three different series were made. One sub-series (A) had rather long and thick and slightly diverging side hoofs and a large squarish front hoof. The second sub-series (B) differed in having slightly shorter side hoofs, that were less diverging and more parallel to each other. The third sub-series (C) had a narrower and less square front hoof, and contained most of the sets. The ranges of all three sub-series were completely overlapping.

The differences between the series were so slight that it was often difficult to assign a set to one of them, and in some cases that was even impossible. This is illustrated in figure 3.19, that shows outline drawings of the best casts, three of each sub-series. The solid lines are from earlier sets of the sub-series A, the long dashes are from later sets of the sub-series B, and the small dashes are from casts of the sub-series C. Apart from the slightly greater length of the side hoofs in sub-series A, the outlines are very similar in size and shape. With increasing insight into the influence of soil and movement on the prints, and after the study of other series had shown that the length of hoofs can change in the course of time, a revision was needed. The series were laid out once more and casts and outline drawings were compared again.

It was found that differences in length of side hoofs do exist, but the longer hoofs are found only in the older sets, and the later sets do not show a difference in side hoof length between the sub-series. The differences in position of the side hoofs are so slight that they are often less than the variation that is found between casts of one set, and the differences in width of the front hoofs are also not significant. All casts with a narrow front hoof were obviously made in rather soft soil, which accounts for the reduced width (see chapter 3.5.2). Therefore it was concluded that all sets were probably made by one rhinoceros and the three series were merged into series 520, in which the side hoofs show a small reduction in length throughout the study (see figure 3.18).

In figure 3.20 the amount of variation that was found in the outline drawings of series 520 is illustrated. In the lower drawing the outlines, without the plantar ledges and the basal line, of the ten best casts of the left foot are superimposed, so that they show the most complete overlap. The outline of the front hoof was placed in the same position and the outline rotated around that position until the best overlap of the side hoofs was attained. The left foot casts were chosen because in some sets they are better and more complete than the right foot casts. In the upper figure the outline of the best cast (cast 49.7 L) is drawn with the tips of the hoofs from all 37 complete left foot prints in the series (the dots). They were superimposed in the same way as the outlines in the lower drawing.

From this figure it will be clear that there is considerable variation in the position of the side hoofs, as has been explained already in chapters 3.3.2 and 3.5.3, probably caused largely by external forces. But the variation in the direction of the length of the hoof is relatively small, compared to the variation in the direction perpendicular to the length axis. Most dots are located in a more or less crescent-shaped area, 5 - 6 centimetres long and 1 - 2 centimetres wide. The shaded area in the upper figure covers 50 % of the tips that are closest to the middle or medial axis of the whole group of dots. The outline and the shaded area are shown also in the figures 3.21 to 3.23, where this series is compared with other series.

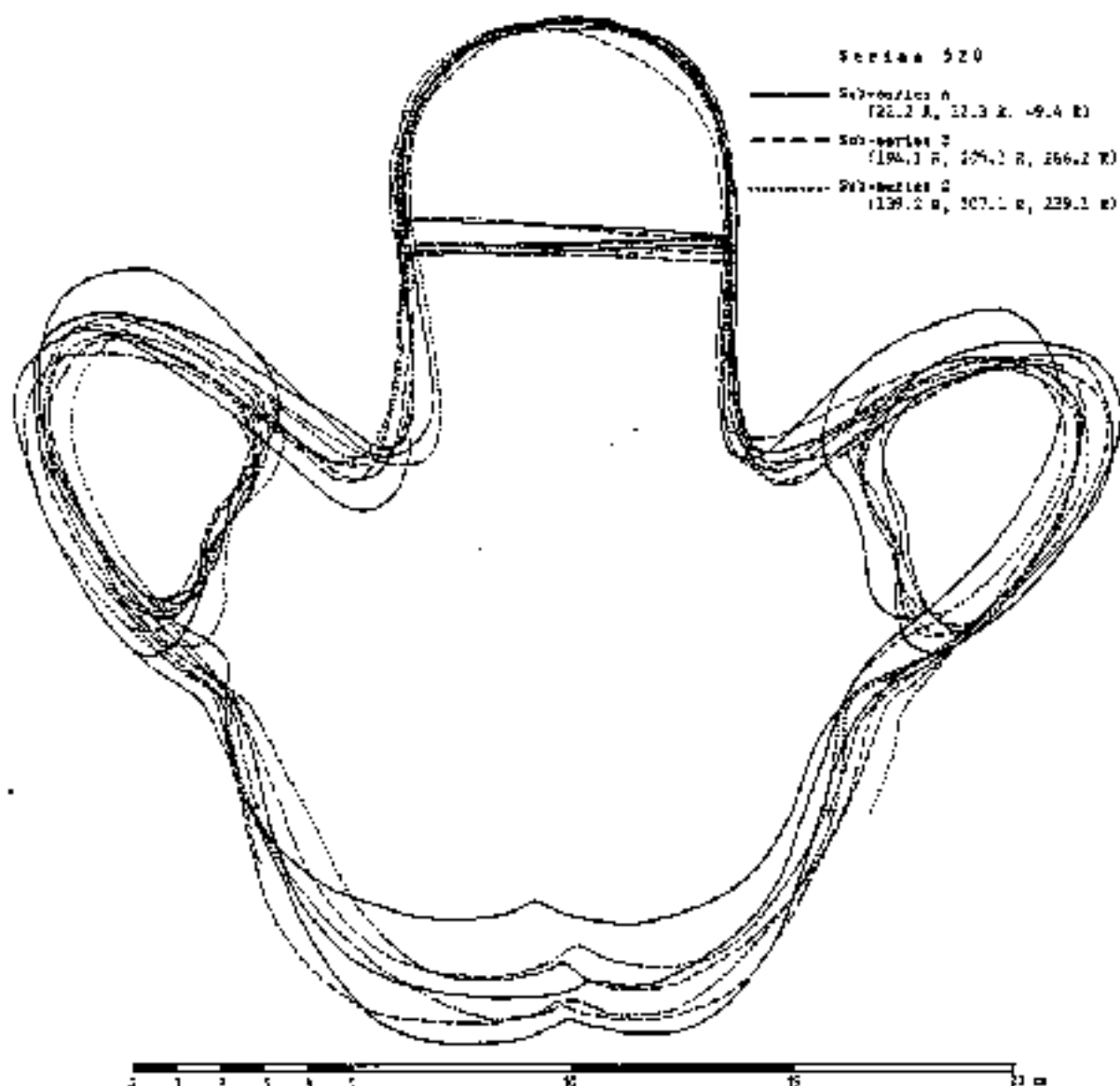

Figure 3.19 - Superimposed outline drawings of the three sub-series that were initially formed from the casts that were later grouped as series 520. This is the largest and most complete series and was chosen as a model series to explain the differences that exist between the different series of casts. The only difference between the three sub-series was a slight difference in the length of the side hoofs (see also figure 3.18). Later the differences were found to be inconsistent and most likely caused by a gradual shortening of the hoofs (see also chapter 3.5.6), and all casts were merged into one series.

3.6.2 - Comparison with other series

To illustrate the nature of the differences found between the series, the model series 520 is compared with those series with which it has a superficial resemblance, and with those series that have an overlapping range in the study area. The comparison of the outline drawings is illustrated in the figures 3.21 to 3.23 where the outline of the best cast of series 520 (the thin line) is overlaid with the outline of the best cast of the compared series (the bold line). The shaded area covers the middle half of the positions of the tips of the side hoofs, as in figure 3.20, of series 520. The dots represent the positions of the tips of the side hoofs of the other series.

Figure 3.21 shows the outline of series 520 in comparison with three series that show a superficial resemblance to the model series, in the form and position of the hoofs. Series 191 is the most similar series and the prints appear identical on first sight. The front hoof is very similar, rather thick rimmed, squarish, without thickened lobes or ledges, and also the form of the side hoofs is very similar. The outlines shown in figure 3.21 do not show any clear differ-

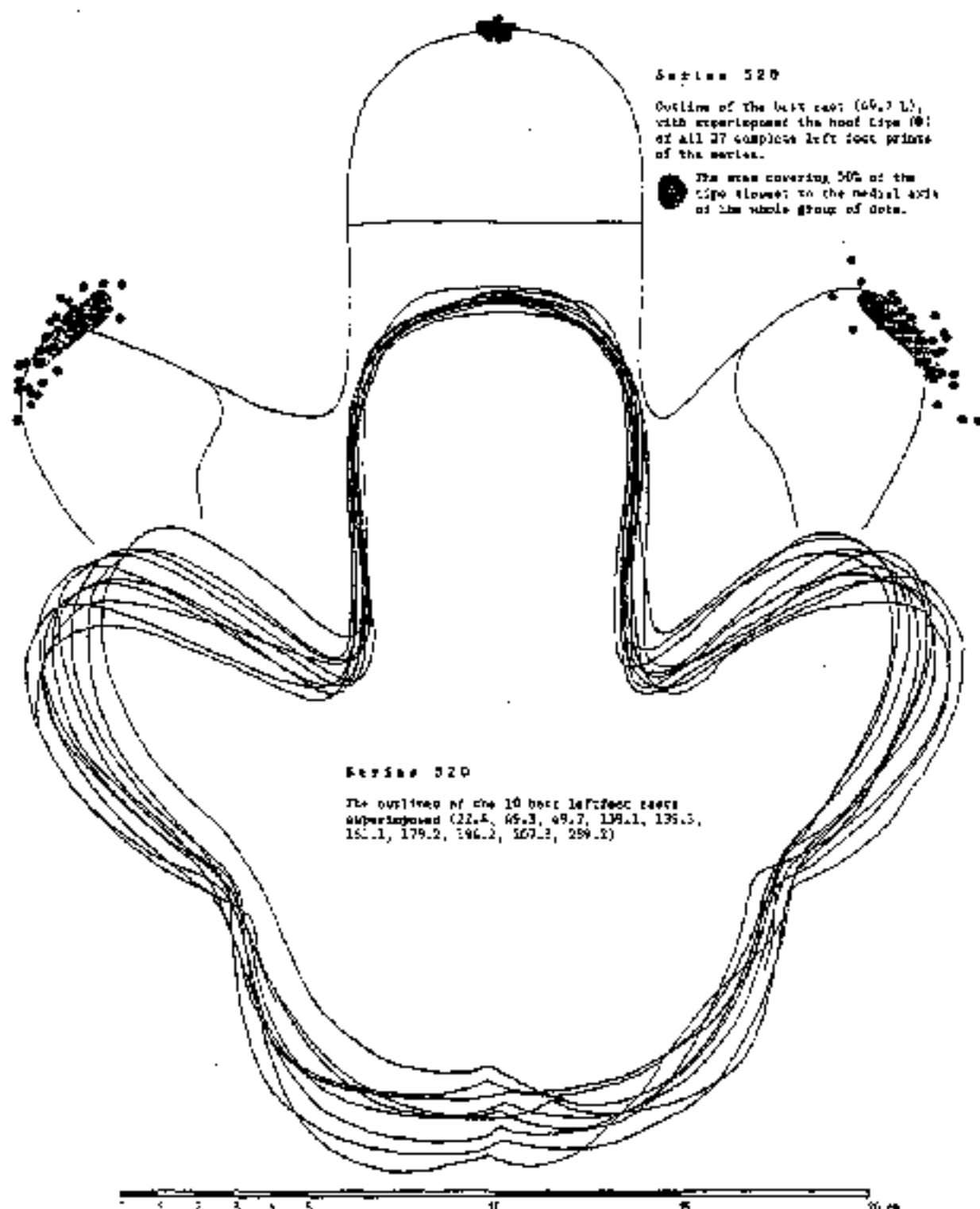

Figure 3.20 - Outline drawings of the model series 520, as used for comparison with other series. The lower figure shows the superimposed outline drawings of the 10 best casts of the series. The differences within one series are mainly in the position of the side hoofs, caused by external forces (see chapter 3.5). Similar pictures were obtained during the process of sorting by superimposing the outline drawings on a light table. Small series of outline drawings could easily be compared in this manner.

The upper figure shows the compound outline drawing of series 520, with the outline of the best casts and the tips of the hoofs of the other casts, that were made to illustrate the differences between the various series, as described in chapter 3.5.2. The same figure is shown together with the compound outline of other series in the figures 3.21 to 3.23

ence. The left side hoof appears to be much broader in series 191, but that is only so in this cast, and is most likely an aberration. The only consistent point of difference between these two series is the position of the median side hoof, that is parallel to slightly diverging in series 520 (see the stereophotographs of set 49 in figures 3.9, 3.12, 3.14) and that is in the more normal converging position in series 191 (see the stereophotograph of cast 35.1 L in figure 3.26). A difference like this cannot be seen on the outline drawings, but it is clearly visible on the casts, even on the poor ones.

In the multiple analysis of variance of the standard measurements (see chapter 10) these series were found to be significantly different in the width of the front hoof only (Series 520: mx 73.0 sd 2.4. Series 191: mx 75.0 sd 1.4). Another indication that these series are made by different rhinos is their distribution in the field. Series 520 is found in the northern half of the study area, while 191 is found in the southern part, and between these two distribution centres there is a distance of three kilometres where tracks of this type were never found (see chapter 3.1.3).

Series 192 was found only around the Pinus saltlicks, and is clearly different from series 520 in the position of the side hoofs, which are converging, and by the form and width of the front hoof (see the stereophotograph of cast 276.3 R in figure 3.25b). The front hoof is clearly broader (mx 78.8 sd 1.5) and much more rounded in shape. Series 192 shows more resemblance with series 191, and also their ranges are overlapping, making it difficult to separate the two. It is only the shape and the width of the front hoof (the difference was found to be significant) together with a more diverging position of the lateral side hoof on the left foot that has led to separation of these two series.

The third series that shows some resemblance in general appearance to series 520, is series 880, found in the extreme north of the study area. The front hoofs are similar, but the prints are much smaller, which is also clearly shown in the outline drawings (see also the stereophotograph of cast 155 L in figure 3.26b). Differences between these two series are clear and unmistakable. These series differ significantly in the span of the print (series 520: mx 320.2 sd 9.7. Series 880: mx 305 sd 4.6).

Six other series have a range that overlaps with the range of model series 520. The outlines of these series are shown in the figures 3.22 and 3.23. In general these series are all clearly different from series 520, and this shows in the outline drawings. Series 610 is much larger in all aspects (significant differences in all standard measurements), with very flat hoofs (see the stereophotographs of cast 259.1 L in figure 3.26c). Series 110 has a smaller width (not significant), but a peculiar and remarkably large front hoof (mx 83 sd 2.5. See the stereophotograph of cast 198.1 L in figure 3.27a), which distinguishes it from all other series. Series 460 has wide and flat prints, resembling series 610, but with much smaller front and side hoofs (front hoof mx 69.0 sd 1.9. See the stereophotographs of the casts from set 142 and 144 in figure 3.10). The differences with the model series are clear (significantly differing in the width of the front hoof), but the distinction between this series and the other series that have small hoofs is much less clear.

Series 199 has a much smaller front hoof (mx 70 sd 1.1) than series 520, but resembles this series in the form and the position of the hoofs. In size it resembles series 460, but can be distinguished on the form of the front hoof, which is squarish in form (especially on the right foot) and in the position of the side hoofs. In series 460 the lateral side hoof is strongly convergent, while in series 199 it is almost parallel. The width of the print was found to be significantly different (series 460: mx 206.7 sd 12.7. Series 199: mx 221 sd 5.7).

The series 140 and 146 are both clearly different in size from series 520 (see the stereophotographs of casts 78.2 L in figure 3.24a and 210.1 L in figure 3.27b), but these small prints are difficult to separate because they show few special characteristics. Small differences in shape and position of the hoofs are often the only characteristics available for distinguishing between individuals. The series 140 and 146 can only be separated with difficulty, on the front hoof, which is slightly broader and shorter, more rounded and with a hollow planar surface in series 146 (The front hoofs differ significantly in width. Series 140: mx 66 sd 1.5. Series 146: mx 68.2 sd 2.1). For the rest they are similar. The ranges of these two series are adjoining, but on two occasions tracks of both series were found far apart, while in the area in between no tracks of this type were found, another indication that there are indeed two rhinos with almost identical footprints.

(Figure 3.21 - continued)

that is clearly broader and more rounded (see stereophotograph 3.25b and the front hoof drawings in appendix A). Series 191 and 192 are found in the same area and are difficult to separate. They can be distinguished only on the size and shape of the front hoof and on the different position of one of the side hoofs.

Series 880 - The front hoof and general appearance are similar to series 520, but the casts in this series are clearly much smaller (see stereophotograph 3.26b).

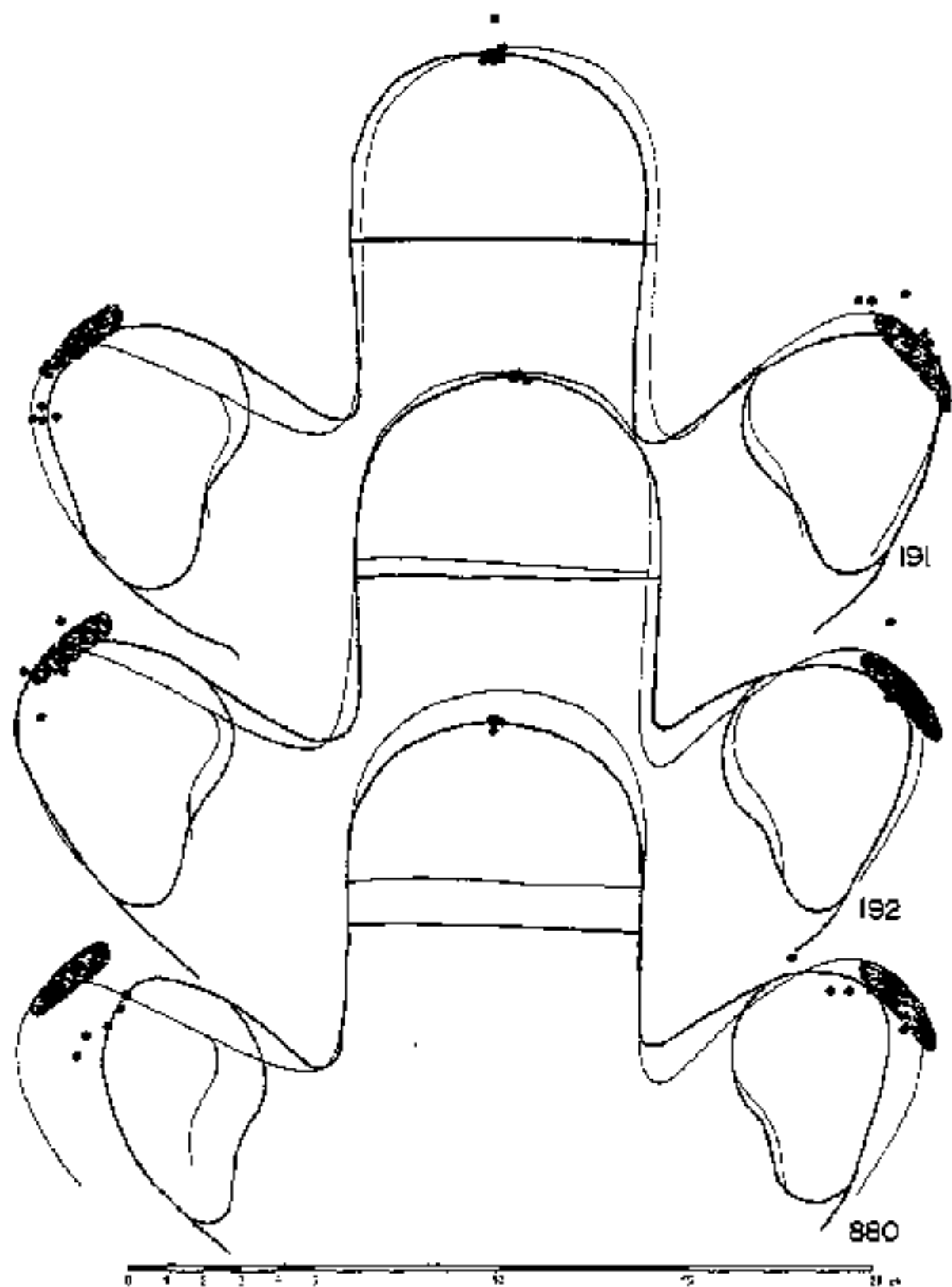

Figure 3.21 - Comparison of model series 520 with three other series that are superficially similar in form. Compare also the stereophotographs of series 520 in figure 3.9c and those in the figures 3.26 and 3.27

Series 191 - This series is most similar to series 520, and the outline drawings show no consistent differences. But in the position of the side hoofs they clearly differ. In series 520 the plantar surfaces of the side hoofs are slightly diverging, while the side hoofs in series 191 are in the standard position (see the stereophotograph in figure 3.26c). Both series were also found in different areas

Series 192 - Differs from series 520 in the position of the side hoofs and in the front hoof.
(continued opposite page)

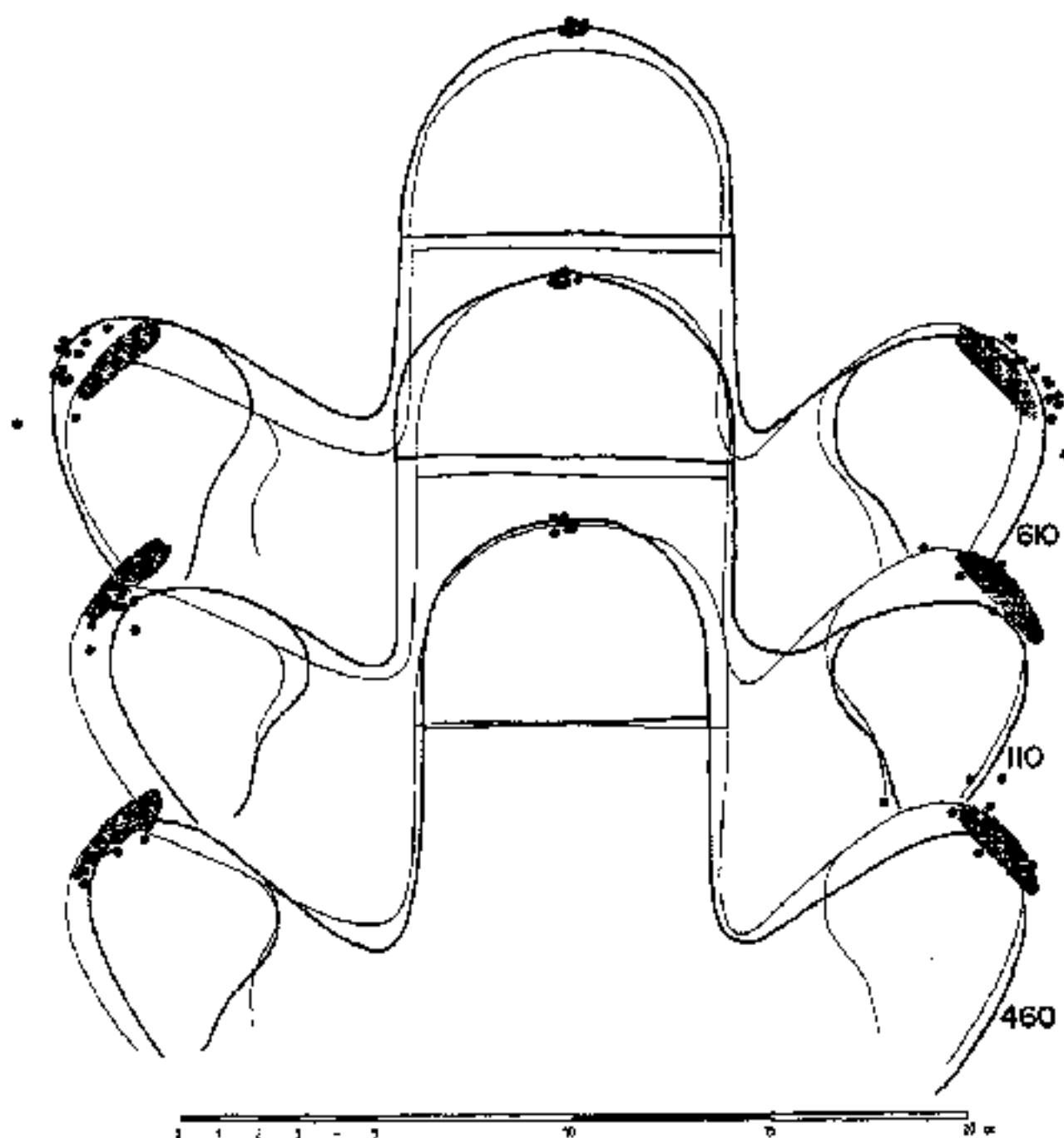

Figure 3.22 - Comparison of model series 520 with three other series that have overlapping ranges. See also the stereophotographs of series 520 in figure 3.9c and those in the figures 3.26 and 3.27

Series 610 - much larger than series 520 in all aspects and with flat outstanding side hoofs (see stereophotograph 3.26c)

Series 110 - A series with an extremely large front hoof (see the front hoof drawing in appendix A and stereophotograph 3.27a)

Series 460 - A much smaller front hoof and flat outstanding side hoofs (see the stereophotographs in figure 3.10). In general appearance this series resembles series 610, but the front and side hoofs are much smaller

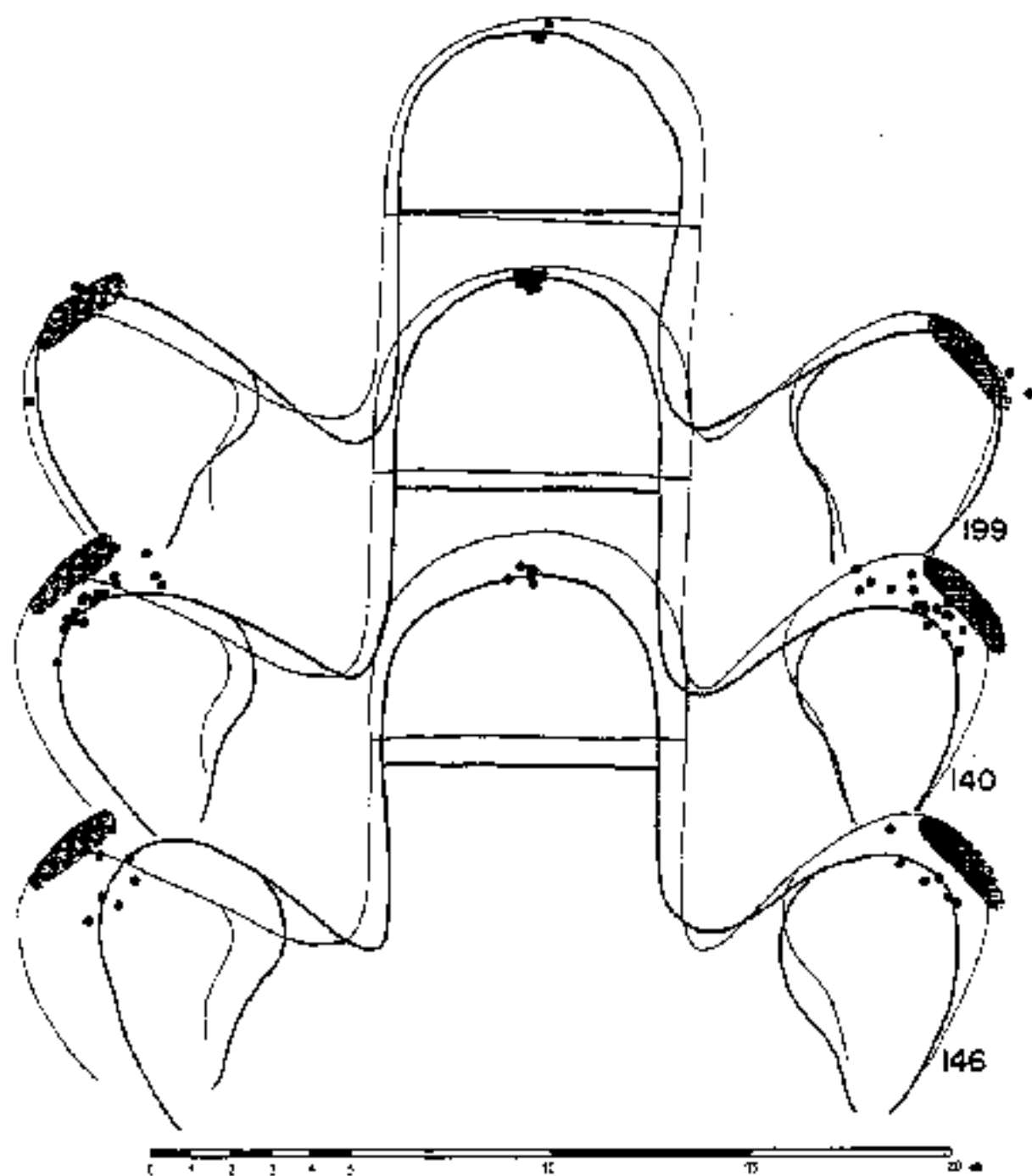

Figure 3.23 - Comparison of model series 520 with three other series that have overlapping ranges. Compare also the stereophotographs of series 520 in figure 3.9c and those in the figures 3.26 and 3.27

Series 199 - This series is rather similar in form and position of the hoof(s), but the front hoof is much smaller (a stereophotograph of this series is not available). In size this series resembles series 460 (figure 3.22), but they can be separated on the form of the front hoof and on the position of the side hoofs

Series 140 - in all aspects much smaller than series 520 (see stereophotograph 3.24a)

Series 146 - in all aspects much smaller than series 520 (see stereophotograph 3.27b). The small prints like those of series 140 and 146 are difficult to separate because they lack clear distinctive characteristics. There are only small differences in the shape of the front hoof and in the position of the side hoofs

Figure 3.24 - Stereophotographs of plastercasts, illustrating different shapes and sizes

A - Series 140. A foot with a relatively long and narrow sole, with a long and slender portion before the side hoofs. The front hoof is in a more horizontal position than is normal. The side hoofs are in a symmetrical position with respect to the midline

B - Series 840. A foot with a relatively short and broad sole with a short tapering portion before the side hoofs. The front hoof is in the normal position, making an angle of about 45° with the transversal plane. The side hoofs are in a symmetrical position with respect to the midline, but they are more inclined towards the transversal or horizontal plane than is normal

C - Series 196. A foot with the front hoof more vertical than is normal, making an angle of more than 45° with the transversal plane. The side hoofs are asymmetrically positioned with respect to the midline, they are in an unusual vertical position and the plantar surfaces converge strongly towards the front hoof

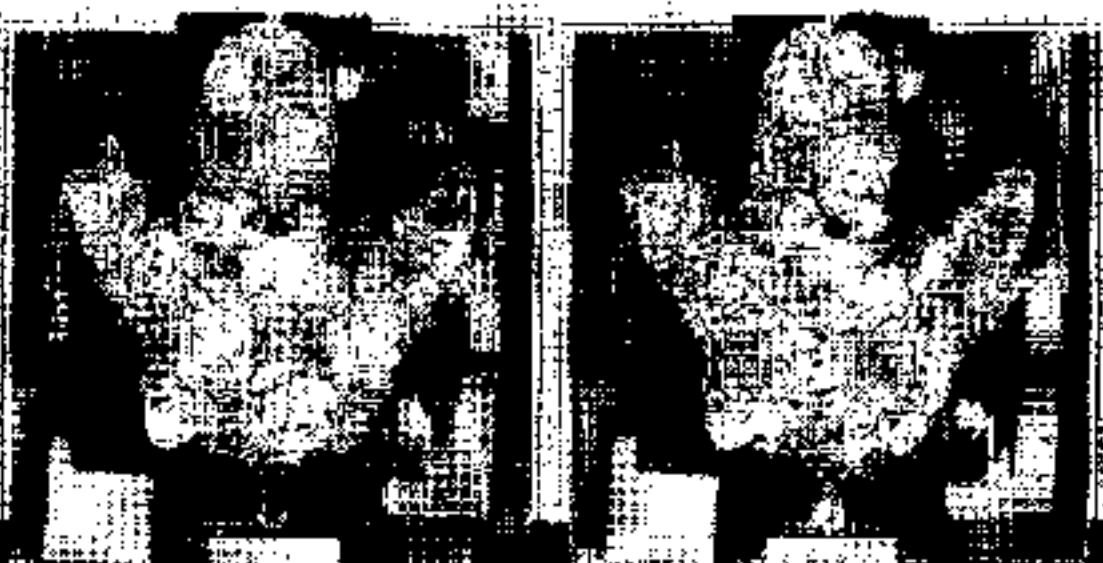

A

B



C

D



E

F

Figure 3.25 - Stereophotographs of plastercasts, illustrating different shapes and sizes

A - Series 296. A foot hoof strongly tilted towards the side. The side hoofs are in an asymmetrical position with respect to the midline, they are more vertically placed than is normal and the plantar surfaces converge strongly towards the front hoof

B - Series 192. A foot that in all aspects comes closest to the standard or average hind foot. The hoofs are in the normal position and there are no peculiarities in form or shape. This cast was used as a standard for comparison with other casts

C - Series 700. A foot with the side hoofs pointing more forward than is usual. The basal ledges of the side hoofs are extremely thick. This is one of the most distinct series and easily recognizable from the casts as well as from the prints in the field

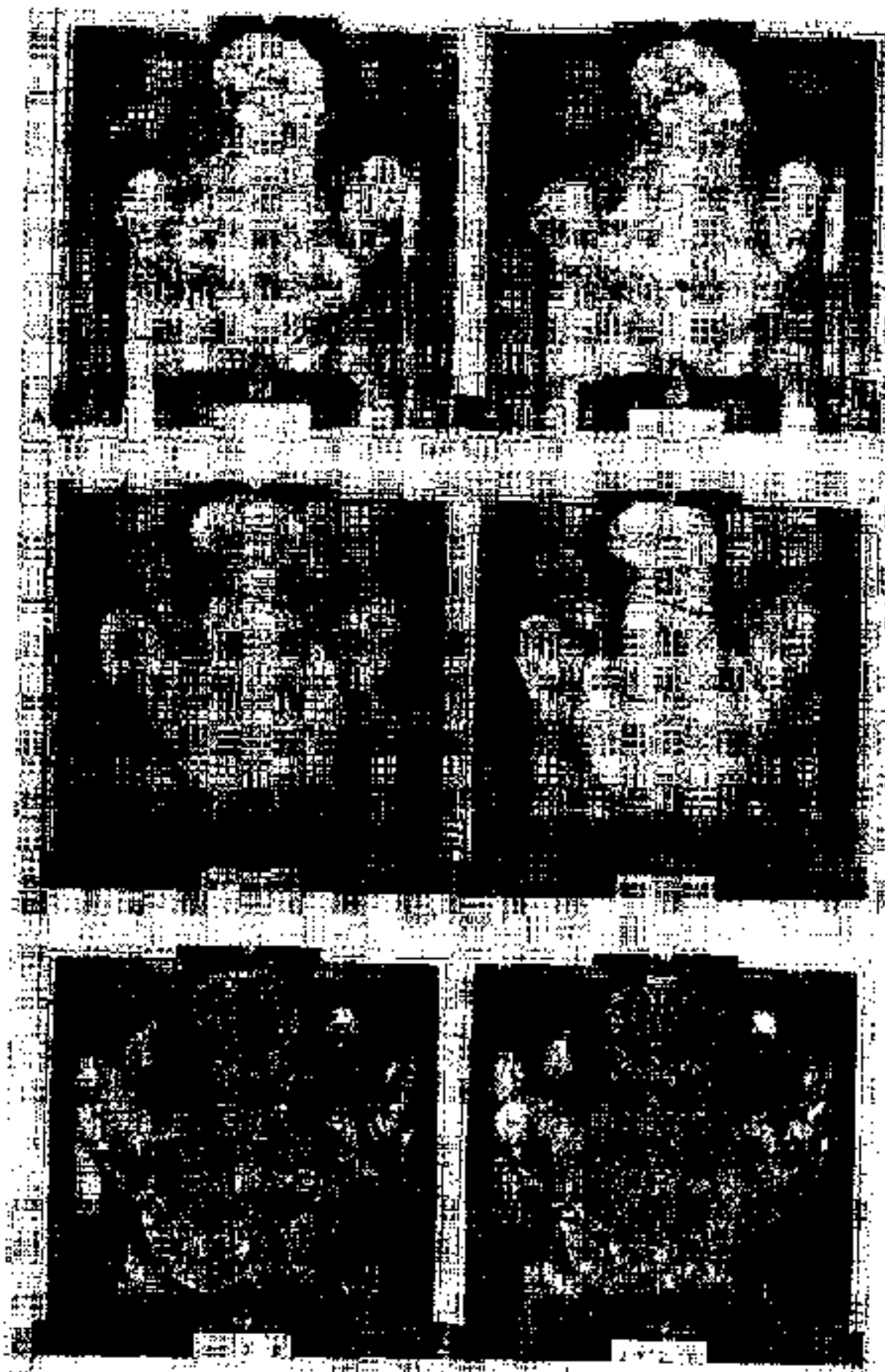

Figure 3.26 - Stereophotographs of plastercasts for comparison with the model series 520. Compare with the stereophotograph of series 520 in figure 3.9c and see also the outline drawings in the figures 3.21 to 3.22

A - Series 131. Differs from series 520 mainly in the position of the side hoofs. The plantar surfaces of the side hoofs of this series are almost parallel, and in series 520 they clearly diverge

B - Series 880, in general appearance rather similar to series 520, but with a different front hoof and much smaller span

C - Series 670, in all aspects larger than series 520, with characteristic flat outstanding side hoofs. This rhino was called 'Flatfoot', in general appearance this series is very similar to series 880 (see figure 3.24b), which is smaller in the width and length of the print. Both series could only be separated after rhino 840 was found with a calf

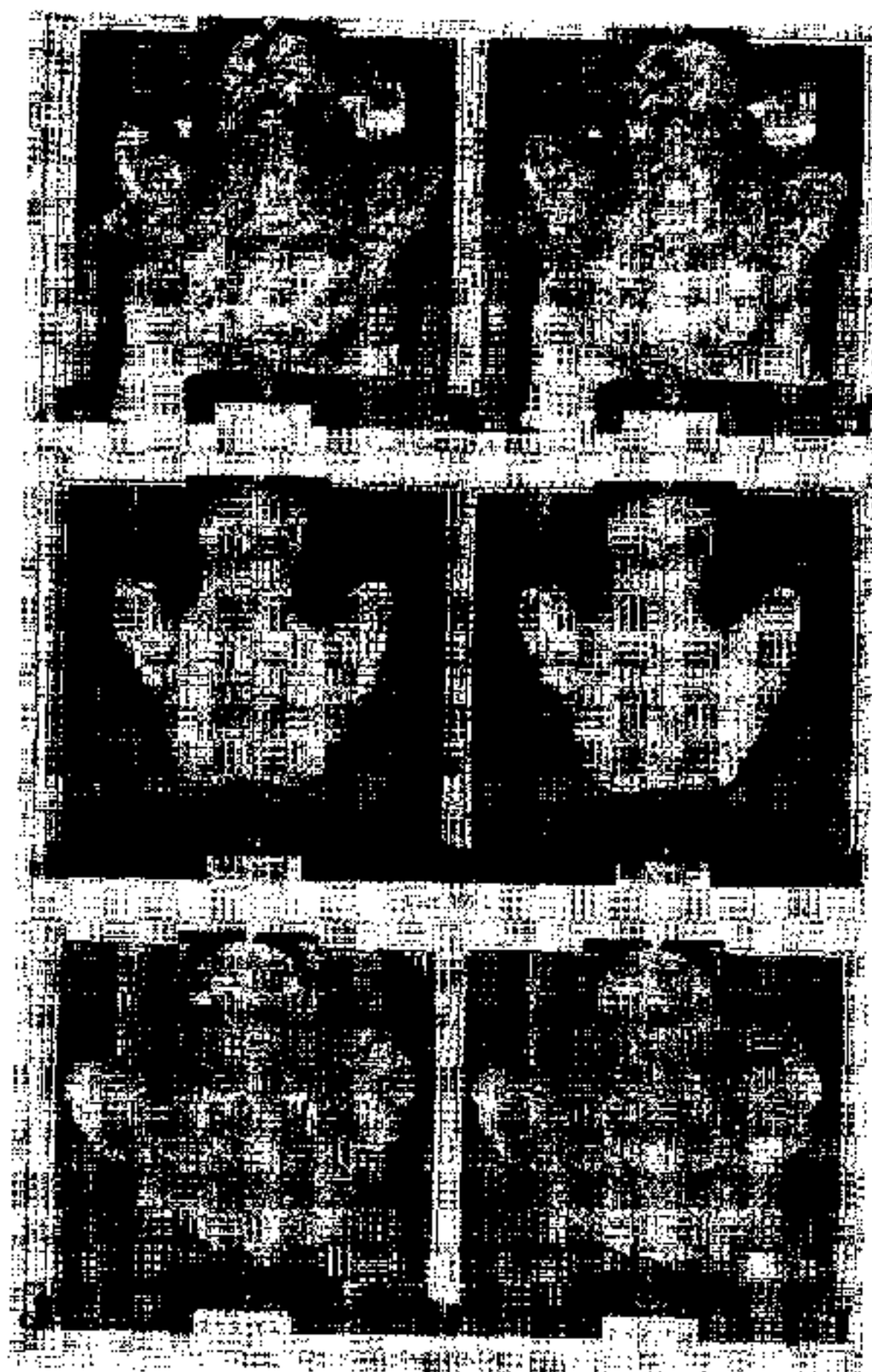
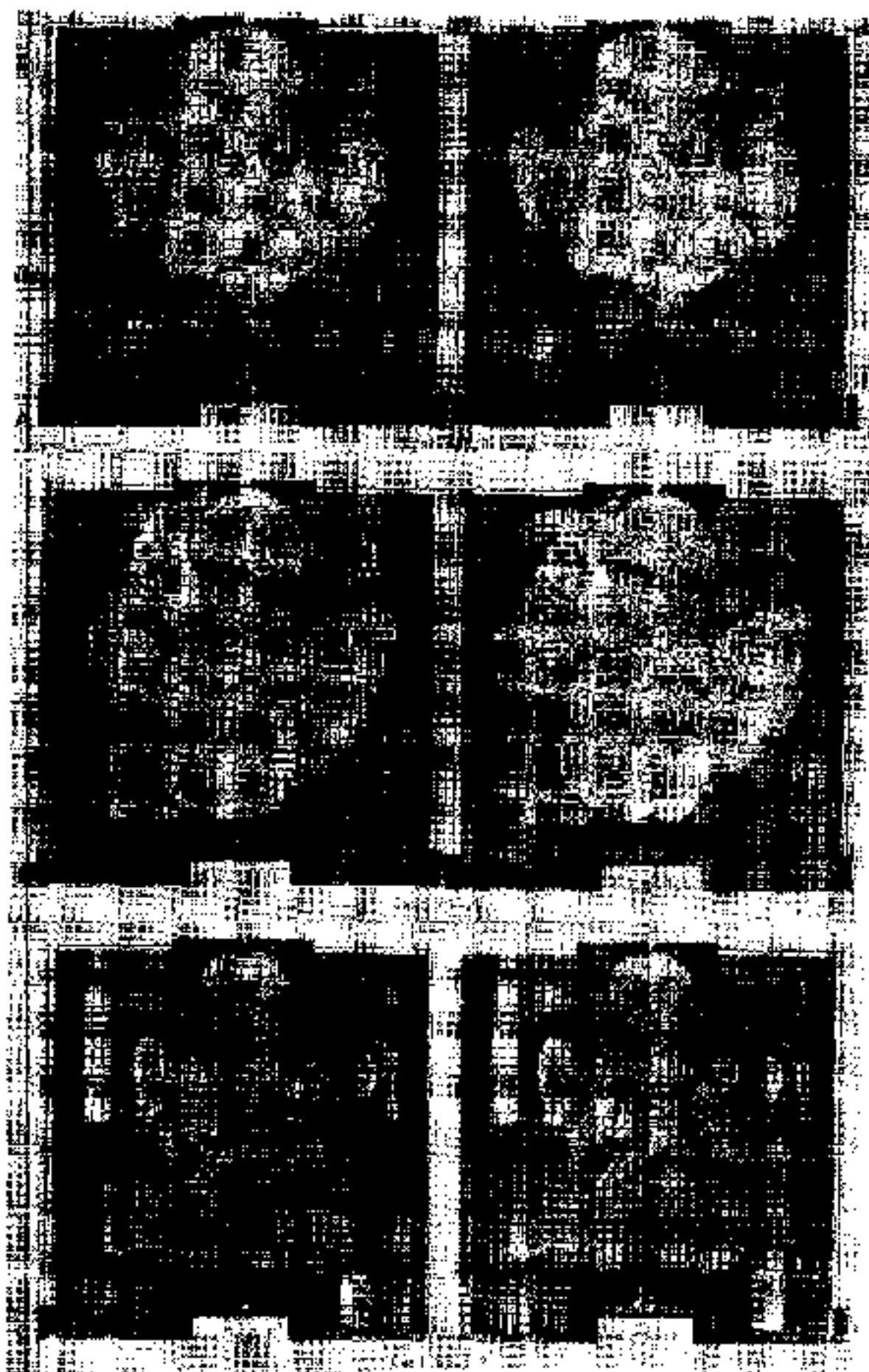

Figure 3.27 - Stereophotographs of plastercasts for comparison with the model series 520. Compare with the stereophotograph of series 520 in figure 3.9c and see also the outline drawings in the figures 3.21 to 3.23

A - Series 110. A series with a very characteristic broad front hoof. See also the front hoof drawings in appendix A

B - Series 145. In all aspects much smaller than series 520. In general these small prints are more difficult to identify than the larger prints. They lack diagnostic features, and can only be separated on small differences in the form of the front hoof and in the position of the side hoofs

C - Series 400. A cast of a calf about 9 months old. See also the drawings in chapter 4



3.7 - Final results of the plastercast identification

By the end of the sorting and identification process there were 39 different series, representing 39 different rhinos, in the plastercast collection. Among these there were 8 cow and calf pairs, with the calves born during the period of the study. In figure 3.28 the record of each rhino throughout the period of the study is shown, arranged by sex and age class (For this arrangement see chapters 4.2 and 4.3).

Most individuals were found on a number of expeditions, but there were often large gaps between successive records. A few animals were found only once in 17 expeditions. The few doubtful records in this table concern sets of poor quality that could not be assigned with certainty to a series.

From the total of 371 sets of casts collected during the study, 324 (87%) could be identified with certainty. The rest were either classified as unidentifiable (22 sets) or were tentatively assigned to a certain series (25 sets). These were invariably incomplete sets, sometimes consisting of just one hoof cast, or cast of very poor quality that did not show any distinctive characteristics. After identification of the casts a distribution map was made for each individual rhino, showing the course and direction of all the identified tracks, the wallows and the saltlicks visited and the dates. The growth of the foot of the young was studied and the possibilities of sexing and ageing based on footprints were considered. Of the 39 animals 8 were identified as females and 4 as males, there were 9 adults of uncertain sex and 17 sub-adults, 12 of which were born during the period of the study.

In the rest of the study the animals that made each series of tracks will be described as 'rhino', or 'male', 'female', 'sub-adult' or 'calf', followed by the series number.

3.8 - Evaluation of the method of plastercast analysis

Individual rhinos can be recognized from the form and size of their footprints. Using the techniques described above with experience one can judge casts for possible aberrations and deformations, and from comparisons determine whether two sets of casts from different tracks were made by the same rhino or by different rhinos. Although there are slight changes in form and growth of rhinos feet, most animals tracks could be readily identified.

Each of the 39 series is based on good plastercasts that clearly show distinctive characters and often supported by other evidence. In fact the number of 39 rhinos in the study area is a minimum. Although a few casts could not be allocated to a series and might belong to rhinos not included in the 39 animals in the study area, with the existing large collection of plastercasts it is unlikely that a regular resident of the study area could pass unnoticed. Any rhinos other than the 39 recognised individuals can only be rare visitors to the study area.

Because so much time and energy was spent on finding the tracks there was temptation to try and identify them all as far as possible. If a set is not assigned to a series, that record is lost. If a cast is wrongly identified the rest of the conclusions will be based on false data. Doubtful cases were reviewed several times but some sets of casts had to be excluded as it was impossible to assign them with any degree of certainty to a series.

Proper identification of all individuals can only be successful when a substantial number of casts have been collected. Some rhinos' feet are similar in form and size, and can only be distinguished after comparison of several casts of good quality. For a few animals the form or the position of the hoofs is distinctive, but most casts do not show any striking features, and the differences between individuals are subtle. Since good prints are rare track analysis requires long periods in the field. Quick results are not possible.

This is well illustrated by a preliminary sorting carried out after the 12th expedition (progress report nr 8, 1978). The 400 plastercasts that were available at that time were sorted by sight and comparing outline drawings of hoofs. Then 15 different series were made, among which three were cow and calf pairs. During the final sorting of the whole collection, from the same material (see figure 3.28) 30 individuals could be recognised, among them 7 cow and calf pairs. Partly this was due to the primitive method of comparison, but it was only after many expeditions that there was sufficient good material to warrant separation of series.

The feet of the Sumatran rhinoceros are variable enough to make individual recognition possible, even on poor plastercasts. Once the tracks have been identified the whereabouts of the different rhinos can be pinpointed. In a habitat where visual observations are almost impossible this is a very valuable tool. Because tracks are preserved for some time if it does not rain, footprints give information on what happened in the recent past. Studying rhino movements from plastercasts of their tracks does not require expensive equipment or intricate organization, but it does require a large amount of plastercasts and a lengthy study. The method could be used to study other large animals that are otherwise difficult to locate. The procedure followed in this study was very time consuming, but it may be possible to simplify the track analysis (see chapter 10).

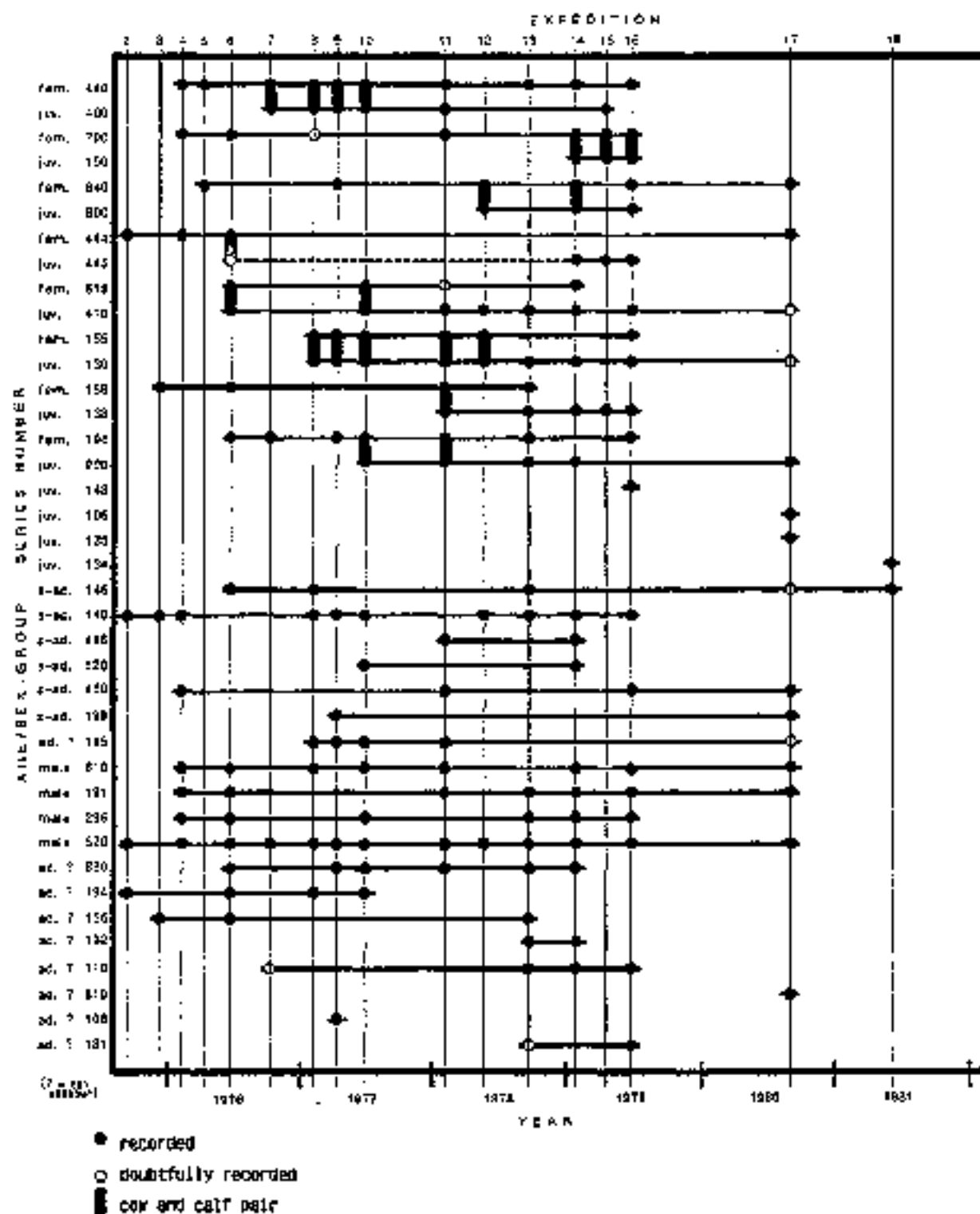

Figure 3.28 - The occurrence in the study area of the different rhinos recognized in the plaster-casts, throughout the period of the study

The results of track identification are in many aspects similar to those that can be obtained by radio-tagging animals, namely a series of locations and dates concerning individual animals. Track analysis requires more time and more energy, but the results can be much more extensive and cover a wider study area. All animals in a certain area can be monitored, and the tracks give information on the activities of the rhinos. Radio-tagging was not attempted in this study, because of the risks to the animals and for financial reasons, although it would have provided a perfect countercheck on the identification of the tracks.

3.9 - Recommendations for future use

Track studies with the help of plastercasts can be very useful for ecological field studies on larger animals, but it is not an easy nor quick procedure. The recommended procedures for a simple census to distinguish individual animals and estimate the minimum number present, will be discussed in chapter 10. For a census a few measurements and casts from front hoofs will be sufficient (see chapter 10), but for ecological studies where one must recognize individual animals every time their tracks are found, one must use casts of complete footprints.

The quality of the casts is of prime importance for successful identification. Incomplete casts and those of poor quality are very frustrating to work with. In the field one should take enough time to follow fresh tracks until several good casts can be made. With old tracks one is dependent on luck to find suitable prints, but with fresh tracks one can usually find a number of good prints if one follows the animal's track. Two good casts of each foot should be sufficient, but one should try to have enough plaster to make a few more if necessary. In the field it is not always easy to see which prints are most suitable for casting and cast should be inspected as soon as they are hard and can be lifted, so that more can be made if needed. If complete prints cannot be found it is useful to make some casts of single hoofs.

To sort and identify casts with accuracy takes practice. The best way to accustom oneself to the different forms and the variability in plastercasts is to make a larger number of casts from a few different tracks. While following the track one should make casts in different soil types and on different slope gradients, a few at each location to learn how soil and slope influence the form of the casts. Later one should always try to avoid making casts from prints in extreme positions or on less suitable soil types, but often there will be little choice.

The sorting procedure in this study was lengthy and repetitious. Although it is good practice to start comparing casts as soon as possible, no reliable results can be expected before a sizeable collection is accumulated, probably 50 to 100 sets of good casts. Identification should be revised and compared throughout the study.

Outline drawings were found to be very useful for comparison. Casts can also be pre-selected on size and certain peculiarities in form. Cow and calf pairs are often easy to separate because there are two sets of tracks to compare. Single animals can be sorted later, starting with those with an extraordinary form of some part of the foot. The hardest part of the sorting procedure is dealing with the many cast that show no distinctive characters.

After these first selections one should review the whole collection several times, gradually refining the identification and placing the questionable casts. In this final stage of the sorting other considerations, like the time and place of finding, are taken into consideration. One should pay special attention to aberrant records, tracks found at odd places and times, and careful comparison of casts from individuals which have largely overlapping ranges or seem to replace each other in time. Finally one should compare all individuals whose feet show some degree of similarity or have overlapping ranges.

CHAPTER 4 - GROWTH AND AGING

When comparisons of plastercasts are made over a long span of time effects of growth and ageing of the foot can be expected. Growth in young animals is obvious, but full-grown animals are also likely to show some very slow growth and changes in form of the foot through ageing. Because the breeding biology of the Sumatran rhinoceros is virtually unknown, much attention was paid to the tracks of cows and calves. Tracks of cows with a calf have been seldom reported previously (Hubback, 1939; Borner, 1979), but during the present study a good number of such tracks were encountered and several pairs could be followed for a long period.

The sorting out of these cow and calf tracks was very difficult and time-consuming. As long as the calf is accompanying the mother it is fairly easy to identify, but once the young is independent distinguishing its tracks from other small tracks is much more difficult. The difficulties were aggravated by the fact that some sets of casts included only a few examples of calf prints, because the possibility of more than one cow and calf pair using almost the same area, was not anticipated during the field-work. Often to save on plaster only a few casts were made of a cow and calf pair because they were assumed to be identical to tracks found shortly before; only later were they identified as made by different cows, both having a young of similar age.

Ultimately eight cow and calf pairs could be recognised, and another four calves were already independent of the mother when found for the first time, but from their size they were obviously born during the period of the study.

4.1 - Growth of the foot of the calf

The form of the foot of the young Sumatran rhino has been described and drawn by Bartlett (1873), in his account of the birth of a young rhino on board a ship in the London docks. At birth the hoofs are long and pointed and turned under the foot. Once the long points are worn away the proper form of the hoof can be seen. Unfortunately no size of the foot or hoofs is given, nor is there a scale to the figure of the foot in the article. The newborn animal is described as being "3 feet in length, and 2 feet high at the shoulder". Using this scale for the drawing of the youngster, the feet will be something between 80 and 90 mm in diameter. The drawing of the underside of the foot, published by Bartlett (1873), has been redrawn to this scale (85 mm diameter) in figure 4.2.

Once tracks of a newborn young were found (rhino 700 with calf 100). When first found the tracks were very small, smaller than any calf track found before, and the front hoof had a remarkable squarish profile, as if the long down-turned point had just worn off. Older tracks of the mother, who has a very characteristic print, were found nearby, but not accompanied by a young. These tracks were at most 12 days old, indicating that the infant had begun accompanying the female only recently. Bartlett (1873) relates that the newborn rhino spent most of his time sleeping in a dark place, so it is likely that they normally do not follow the mother the very first days after birth, but remain hidden. Therefore the young was judged to be about 15 days old when it was found for the first time (January 27, 1979, exp. 14). Fresh tracks of the same calf were found on the 15th expedition and old tracks were found on the 16th expedition.

From slightly older calves several series are available, but the best material is found in series 400, calf of rhino 440, and series 130, calf of rhino 155. From series 400 good sets of casts were found three times while it accompanied the cow, and another good set was obtained more than two years after birth. From series 130 the material from the period that the young was following the mother is much less complete, but good sets are available from around the time that the young separated from the cow. Good material is also available from series 410, calf of rhino 515, over a two year period after becoming independent. These four series serve as a reference for the evaluation of the less complete series of the other calves.

In figure 4.1 the growth curves of these four series (100,400,410,130) are shown, represented by the average width of the front hoof, the width of the sole, the span, and the width of the print on each expedition. The curves of the series are superimposed so that visually the best fit is attained. The horizontal axis shows the number of days since the presumed date of birth. The length of the print is not considered here, but it follows a similar curve. The age at which the young became independent is given for all the cow and calf pairs. The last record of a cow and a calf walking together and the first record of the cow or the calf moving independently are shown.

For all the calves similar curves were made and these were compared with the curves in figure 4.1, to estimate the date of birth. The presumed dates of birth will be further discussed

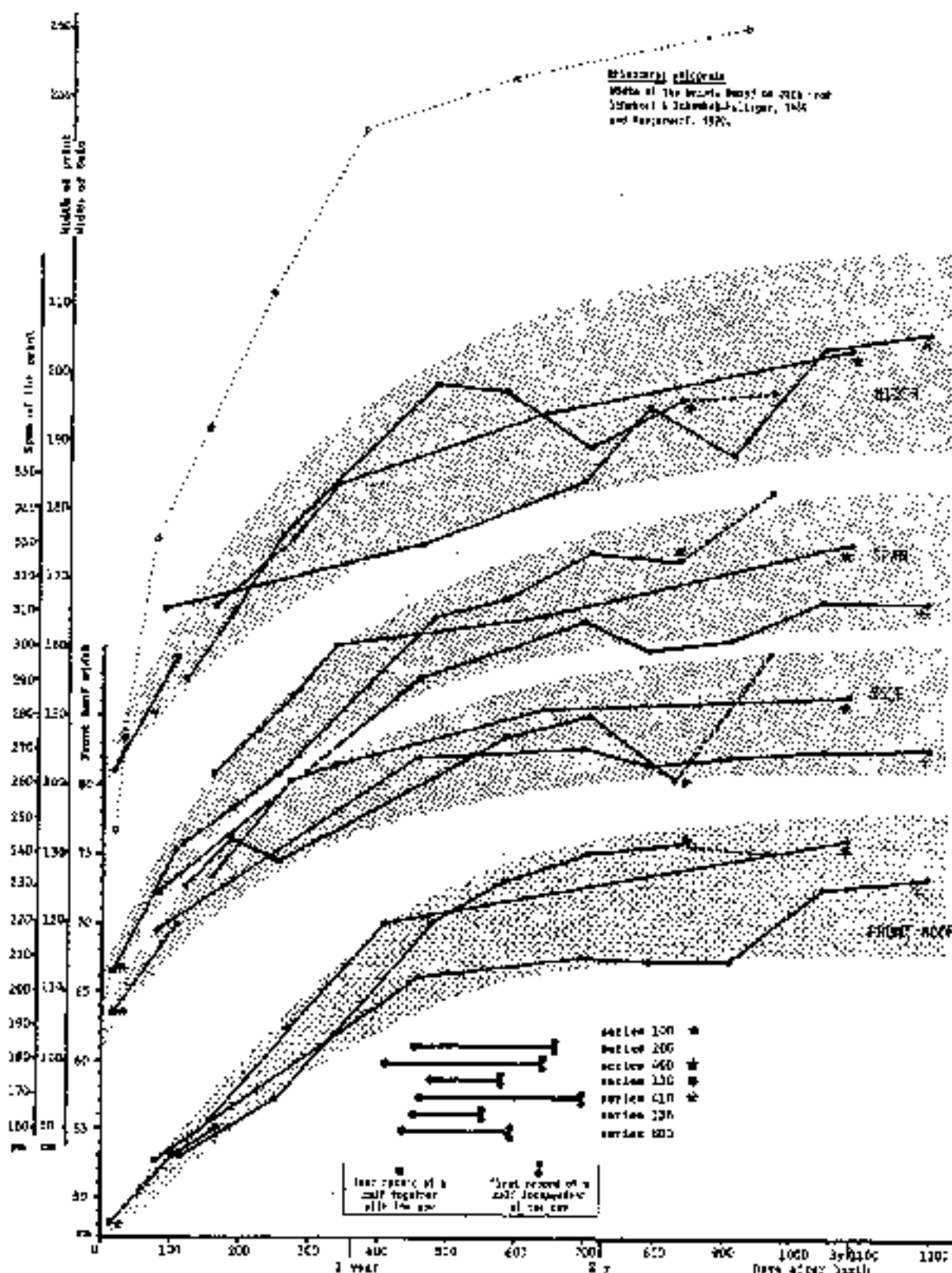
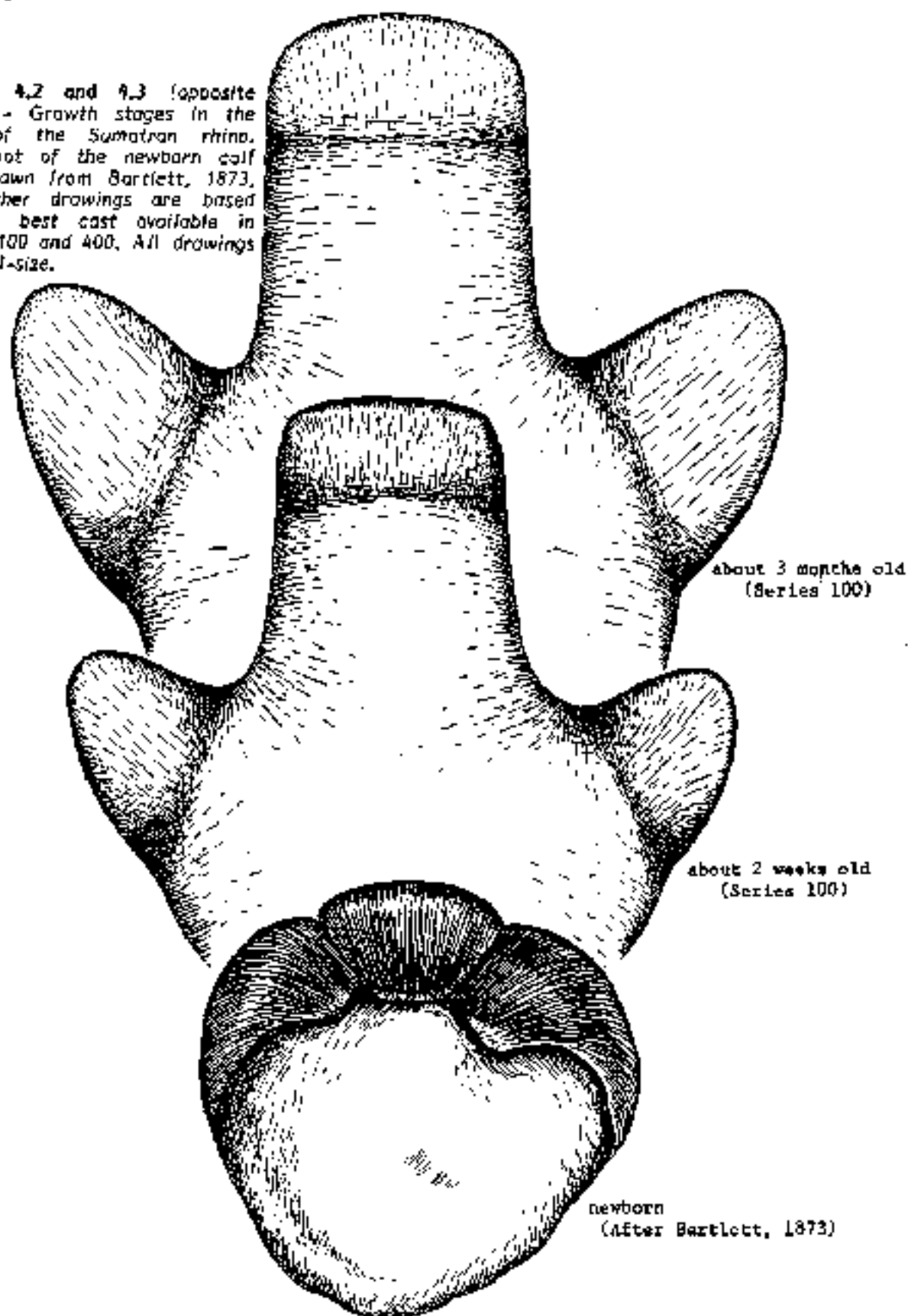

Figure 4.1 - Growth of the foot of the calf, expressed in the growth-curves observed in four standard measurements. The curves observed for four of the calves born during the study are superimposed, so that the best fit is attained. The shaded area, indicating the approximate variance in the values, was sketched in based on the growth curves of all calves. The bars in the lower part of the figure indicate the period between two successive records in which the calf becomes independent. For comparison a growth curve for the width of the foot of the Indian rhino is added.

Figure 4.2 and 4.3 (opposite page) - Growth stages in the foot of the Sumatran rhino. The foot of the newborn calf is redrawn from Bartlett, 1873, the other drawings are based on the best cast available in series 100 and 400. All drawings are full-size.



0 1 2 3 4 5 10 15 20
cm

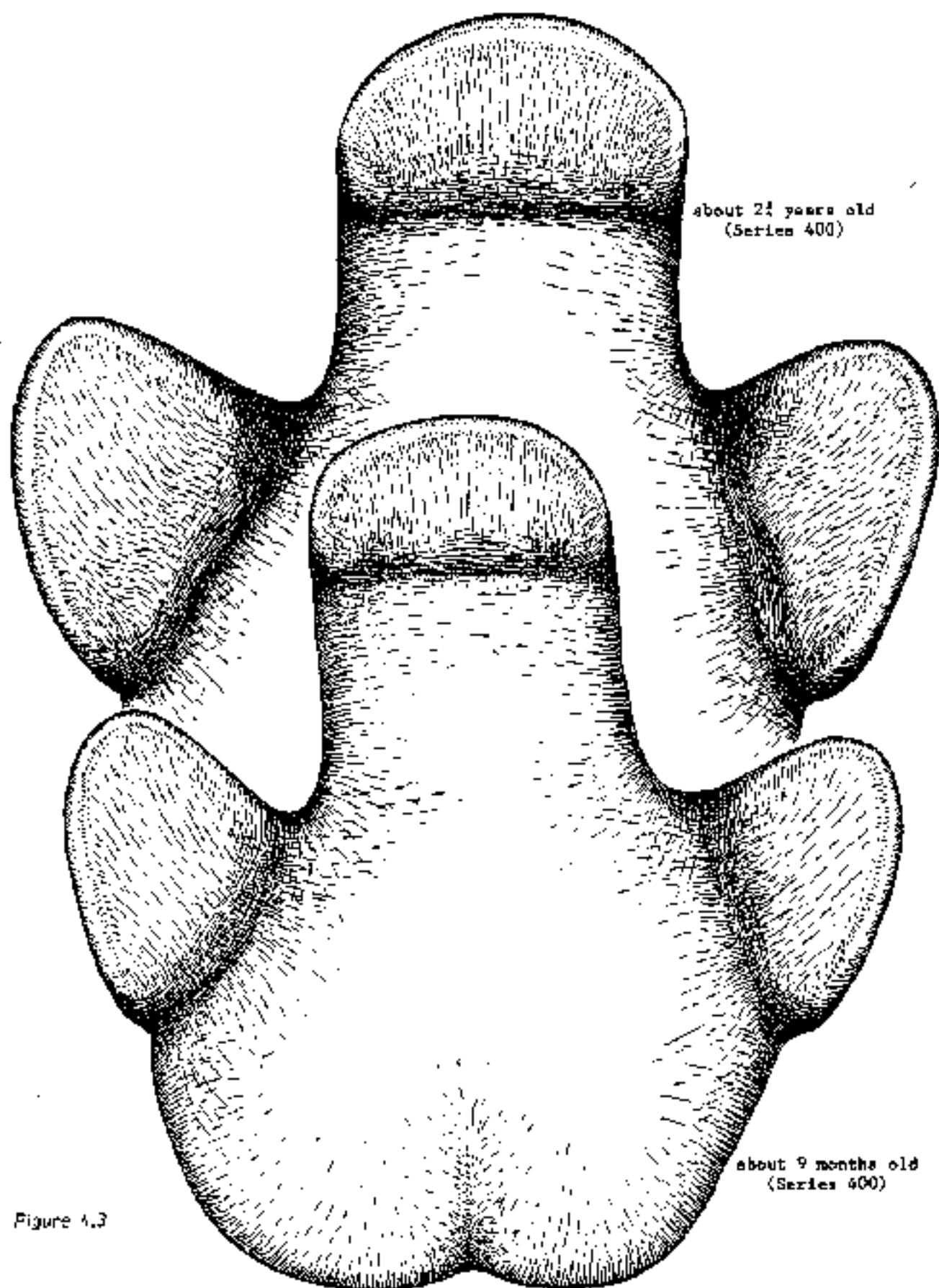
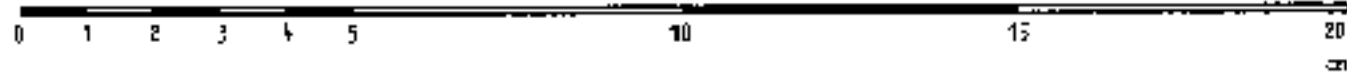

Figure 4.3



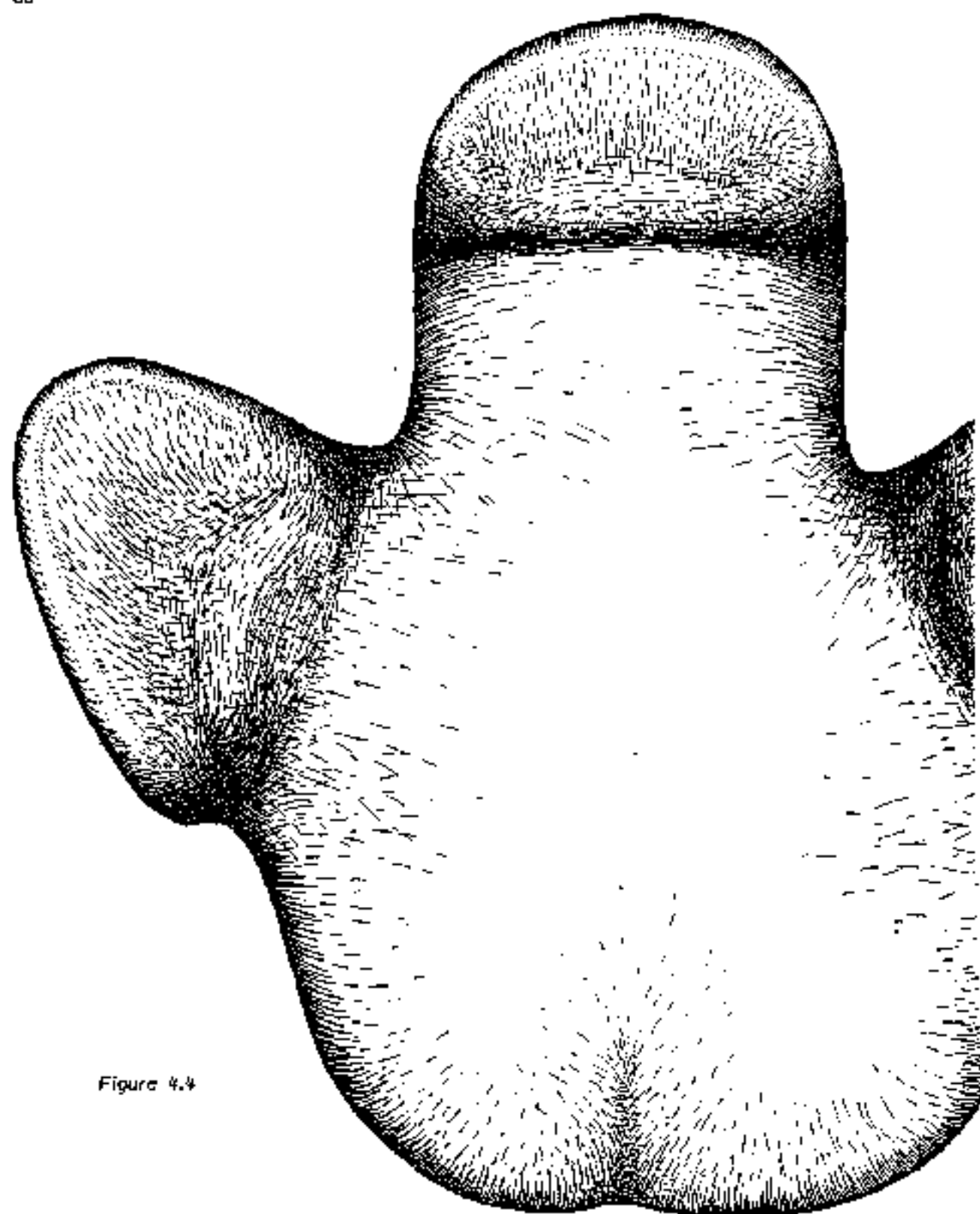

Figure 4.4



in chapter 6.1, here only the ageing aspects of the growth of the calves will be treated. All growth curves of the eight cow and calf pairs that were found at least once together (the date of birth can be estimated with some accuracy), were used to draw the shaded zones in figure 4.1, that indicate the variation of the four footprint measurements against the time after birth. The shaded zone is an approximation based on the available points. For comparison a growth curve of the print width of the Indian rhino (*Rhinoceros unicornis*), based on measurements from zoo animals, is included in figure 4.1 (References in the figure).

While the calf is still young and accompanies the mother the curves are steep and the band is rather narrow. In this stage a track of a calf can be aged rather accurately with the help of this figure. But after independence the curves flatten and the variation is considerable, making it impossible to age tracks accurately on the size only. Nevertheless tracks of this age are still easily recognizable as being from a young animal. These young animals have not only relatively small prints, especially small in the width of the front hoof and the print, but they have also a different appearance. The hoofs, especially the side hoofs, have a rather slender form, with sharp thin edges, which are very smooth and regularly curved. The plantar surfaces of the hoofs are flat with only very faint indications of ledges or lobes (see the stereophotographs of series 460 in figure 3.10, series 140 in figure 3.24, and series 146 in figure 3.27).

As a further aid in the ageing of the tracks of young rhinos, several growth-stages have been drawn to scale in the figures 4.2 and 4.3, based on the best cases available in the collection. The drawing of the foot of the newborn calf is an enlargement to scale of the drawing given by Bartlett (1873). The two-weeks and three-month old prints are from series 100, the 9-month (see also the stereophotograph of this cast in figure 3.27) and the 33-month prints from series 400. In figure 4.4 a drawing of one of the larger prints (male 610) is given for comparison.

4.2 - Age classes

While the age of very young animals can be estimated to a few months on the size of the footprint, for older animals only broad categories can be indicated. For several of the longer series similar growth curves have been made, and a regression analysis performed on the data, but no growth rate for older animals could be obtained. The variation is too large and the points are located too far apart to give realistic outcomes in a regression analysis. Anyhow growth appears to be very slow after the first two or three years. No differences could be seen in size between early and late sets of the same series. This indicates that animals with very wide front hoofs and prints must be fairly old.

Comparing figure 4.1 and figure 4.5 shows that at the age of about three years the maximum print sizes are still much lower than the maxima for the adult animals. This means that the foot must grow considerably in later life, but it is not known whether this is a very gradual process related only to age, or whether there is increased growth during certain life stages. Obviously a wide front hoof and/or a wide print indicate advanced age. Other things that suggest advanced age are peculiar shapes of the hoofs and a pronounced profile of the plantar surface, with thick edges and lobes. Very irregular shapes of hoofs, like the front hoof of series 810 (see the drawing of the front hoof in appendix A), suggest very old age or even senility.

An indication at what size of print adulthood is reached can be found in those series of females known to be adult, because they gave birth to a calf. The lowest values found among these females were tentatively regarded as the lower limits of the range of the adult animals. Moreover none of these eight females had the characteristic appearance of a young rhino, all their prints were either considerably larger, or showed one or more peculiarities in the form of the hoofs.

All series were classified to age considering the size and the shape, as has been described above. Three categories were recognised: juveniles - all calves born during the research period; sub-adults - the juveniles after independence and animals born before the study period, but still showing youngish characteristics in size and shape and presumably not yet participating in reproduction; adults - all known females and the other series that showed characteristics suggestive of advanced age. Four adults were classified as "very old" because of the peculiar worn-down look of the hoofs. Most series were easily assigned to one of these categories and only

(opposite page)

Figure 4.4 - A foot of a large adult male Sumatran rhino, based on a cast in series 610 (see also the stereophotograph in figure 3.26). Full-size for comparison with the figures 4.2 and 4.3.

Four series (156,195,199,460) were intermediate. After further examination series 156 and 195 were added to the adult category and 199 and 460 were included with the sub-adults.

In figure 4.5 the variation in size for each of the categories is shown. There is considerable overlap between categories, with the exception of the front hoof which surprisingly shows only a minor overlap at 71 mm. Although this clear distinction is without doubt partially artificial, it could be useful as a field-characteristic to distinguish between sub-adult and adult rhinos. Anything over 71 mm is adult, anything under it is young.

4.3 - Sex classes and sexual differentiation in footprints

For 8 of the 39 rhinos the sex is known; they were females accompanied by a calf during the study period. Others are suspected to be males, because they were not accompanied by a calf. Since a female Sumatran rhino nurses her calf for up to about 18 months and because it may take as long as three years before a female gets another calf (see chapter 6.4), any animal never accompanied by a calf during a period of at least three years, without interruptions in the records longer than 18 months, was assumed to be a male. Four series (610, 191, 296, 520) qualify in this category. Other rhinos could be tentatively classified as male or female according to such criteria as their distribution, occurrence and behaviour (see chapter 5.1.1 and 5.1.3). All 19 adult rhinos were tentatively classed as male or female. Two rhinos were classified with the 8 females and the other 7 rhinos of unknown sex were tentatively grouped with the 4 males.

The variations in the size of prints made by females and males are shown in figure 4.5. For all measurements the maximum values for the males are slightly higher than those for the females, indicating that the males' prints are generally somewhat larger. Print size is no more than an indication of sex, but this factor can be considered with other evidence.

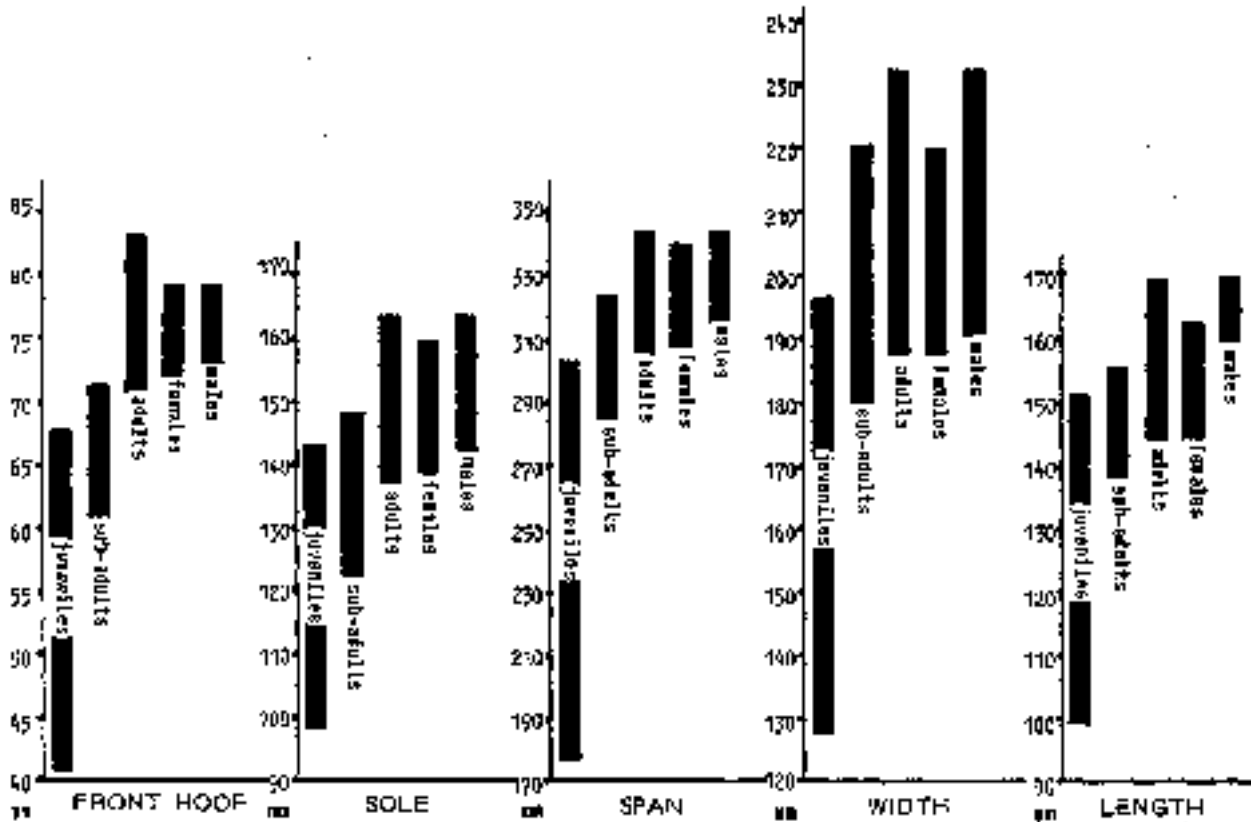

Figure 4.5 - The variation in the standard measurements for the different sex and age classes.

No apparent differences were found in form of the prints between the male and the female series, but it appeared that the females often have a more irregular print, with one or more of the hoofs having an aberrant shape or position. Also the side hoofs are often exceptionally long and most of the examples of changes in length of these hoofs (see chapter 3.5.4) were found among the females. The males have a more regular symmetrical print, with rather broad and regularly shaped hoofs. Probably the physiological stress of pregnancy and lactation influences the growth of the hoofs, resulting in a more irregular growth and form of the foot.

Examples of "typical" male and female footprints are shown in the stereophotographs of females in series 440 (figure 3.14) and 700 (figure 3.25) and of males in series 610 (figure 3.26) and 191 (figure 3.26). On the other hand male 296 (figure 3.25) has a very irregular print and showed a substantial change in size of the side hoof (It is also possible that this animal is in fact a female, but that it failed to reproduce or that the calf did not survive). The prints of female 840 (figure 3.24) and male 610 (figure 3.26) are almost identical in shape, flat with broad rounded hoofs. The prints of the female are clearly smaller, but the similarity in shape was such that initially they were not separated until female 840 turned up with a calf, while the animal making the larger prints was still travelling alone.

CHAPTER 5 - DISTRIBUTION AND DENSITY

In this chapter the spatial and temporal distribution of the rhinos in the study area will be discussed. Basically two different ways of analysis have been used. Firstly all identified tracks of each rhino have been mapped. From these maps it is possible to compare the distribution of the different age and sex classes, changes in distribution over time and total ranges of individual animals. The average densities of rhinos in the study area was calculated from the spatial distribution of the various individuals. From the number of fresh tracks found by the patrols on each section it was possible to discover the parts of the study area most used by rhinos, and how often certain places such as saltlicks and wallows, are visited.

In the following chapters the term 'range' will be used for the area over which the tracks of one individual rhino were recorded. To calculate the size of this range a polygon was drawn joining the outermost records on the individual distribution map (see chapter 5.2). The area over which each rhino extends its daily activities over a long period is regarded as its 'home range'. Obviously the range of each rhino, as shown by its tracks may be only a part of its home range, but the extent and location of the latter may be estimated by looking at the size of the range, the direction of the tracks and the frequency of occurrence in the study area.

Some rhinos, mainly males, use a part of their home range more heavily, for which part the term 'core area' will be used. The rest of the home range, which is only occasionally visited by the rhino, is called the 'peripheral area'. The term 'centre' of the home range is used for the approximate geographic middle of the estimated home range. Most rhinos use specific routes to go to the saltlick, and these parts of the home range are called 'corridor' to the saltlick. Since a female nursing a calf appears to occupy a different area from those she occupies at other times, the home range of a female is split in a 'breeding' and a 'non-breeding' home range.

After each expedition all tracks found were mapped, together with collection numbers, dates and other relevant information. Throughout the process of sorting casts rough maps were made of individuals' movements. After the sorting a final map was made for each rhino including all records from the entire study.

5.1 - Distribution of the age and sex classes

The maps presented in figures 5.1 to 5.7 show the distribution of all individuals in a simplified form. Tracks are indicated by a symbol for each individual, and where a track was followed another symbol is placed every 500 metres. Separate maps were made for the different age and sex classes. For females two maps were made, one showing the ranges while they moved alone and another map for the period they were accompanied by a calf.

The first six maps (figures 5.1 to 5.6) show the actual locations of animals, while the seventh map (figure 5.7) shows the approximate centre of the various home ranges and the saltlicks visited by each rhino.

5.1.1 - Distribution of the females and their calves

Finding tracks of a rhino accompanied by a young calf was always an exciting and joyous moment, and particular attention was paid to those parts of the study area where nursing cows were known to reside. It soon became clear that females with calves have a different distribution pattern compared to other individuals. Usually they were found in the vicinity of a saltlick which they visited relatively frequently. Tracks of the same cow and calf pair were generally found in a number of places on one expedition, and when fresh tracks were found there were often also old tracks in the same place, indicating repeated passage. Surprisingly often the nursing female's tracks were not of the well-known individuals, but appeared to be new in the area. When cow and calf separated the calf normally remained in the same area, but the cow seemed to leave the area.

Comparing the distributions of the same females for the periods with (figure 5.2) and without (figure 5.1) calf reveals considerable differences in their ranging behaviour. In the period that they are without a calf, the female rhinos are found relatively seldom, usually in the higher

parts of the study area, away from the bigger rivers. If they come lower it is usually for a quick visit to a saltlick. But with a calf they are much more frequently found at lower altitudes and from their abundant tracks it can be concluded that they make relatively frequent visits to the saltlicks (see chapter 5.6).

The non-breeding females appear to prefer the ridges and there is very little overlap in range between different individuals. The non-breeding ranges of the females are well separated from each other and they seem to be evenly distributed over the area. Non-breeding females only come together near the saltlicks, but actual overlap was minimal, because each rhino uses a specific corridor to the lick and usually does not deviate from this path. The range of rhino 195 (probably female) does not overlap with any of the other females (see figure 5.6).

A breeding female with a calf appears to shift its range to an area close to a saltlick. Then they are found frequently in the lower parts of the study area, where the saltlicks are located. The breeding ranges of the cows show considerable overlap near the saltlicks and several times tracks of two different cow and calf pairs were found very close together at about the same time.

When comparing the distributions of the females with calf (figure 5.2) with the distributions of the calves after separation (figure 5.3), it is apparent that the calves remain in or close to the area where they wandered with the cow. The cow after separation presumably retreats to its non-breeding home range, higher on the ridges. The calf remains for some time (at least 2 to 3 years) in the area where it was found together with the cow, in the lower parts of the study area, close to the saltlicks. Usually the area over which it wandered with the cow is larger than the area it occupies in the first years of independence, but once independent it also seems to explore adjacent areas probably for the first time. The ranges of the independent calves show considerable overlap. In several instances tracks of two or three calves were found within a few hundreds of metres from one another, using the same trails. It could be that in some cases these calves were walking together or were following one another's track, but they certainly do not associate for longer periods, or tracks of the same groups or couples would have been found more frequently together.

The following examples will clarify and illustrate the general observations made above. Female 440 was found twice before giving birth and four times after separation from the young, and her tracks during these periods were found exclusively on the trail leading north from saltlick 1. Mostly the tracks followed the trail closely, indicating that the animal was moving deliberately to the saltlick. From her wandering tracks found further north it was concluded that this animal usually ranges east of the most northern extension of the study area, but regularly visits saltlick 1.

On the four occasions when this female was found with calf 400, it was not only traveling along the northern route, but also east and south of saltlick 1, almost as far as camp Aceh. Each time the pair visited the saltlick, but from different directions and they did not return in the same direction but moved on to new area. Their course was usually meandering, often leaving the main trails and wandering through the forest. Several times they descended to the Mamas river, and occasionally swam for a short distance, but they never crossed over to the west side of the river.

Similarly female 700, a visitor to saltlick 2 was found three times before the birth of her calf, and always in the northwest corner of the study area, on a route leaving the study area. She consistently followed the same route every time, never deviating one step from the trail. With her calf she was found twice away from this route, approaching the saltlick from a different direction. Both these females appear to have the main parts of their non-breeding home ranges outside the study area, entering only to visit a saltlick. Accompanied by calves they spend much more time in the study area, presumably to remain in the vicinity of the saltlicks.

Records for Female 840 show a different pattern. This animal was found four times without calf, walking around west of camp Aceh (Jalan Sudirman area) and upstream of saltlick 3, outside the study area. Once she was found on the route along the Mamas, going to saltlick 1. Travelling with her calf (rhino 800) she was never found in the Jalan Sudirman area, although this area is patrolled every expedition, but only around saltlicks 1 and 2, apparently using saltlick 1. This female's non-breeding home range seems to overlap a fair part of the study area, from where it frequents saltlick 1. With calf she, too, appears to concentrate her activity around the saltlick, and the breeding home range is probably located along the Sungai Markas because the tracks came from that direction.

The records for the fourth female (444) in the northern part of the study area are very incomplete. She was only found a few times east of camp Aceh, on expedition 6 accompanied by a small calf. No casts could be made of the calf and the pair was never encountered again. During the 14th and later expeditions a young rhino (445) turned up in the same area, and could well have been the young of 444. The female has never been found at a saltlick, but because calf 445 visited saltlick 2, it was assumed that 444 goes there too.

The two females from the central part of the study area (515 and 155) show identical patterns. Without their calves they were seldom found, and only near the western boundary

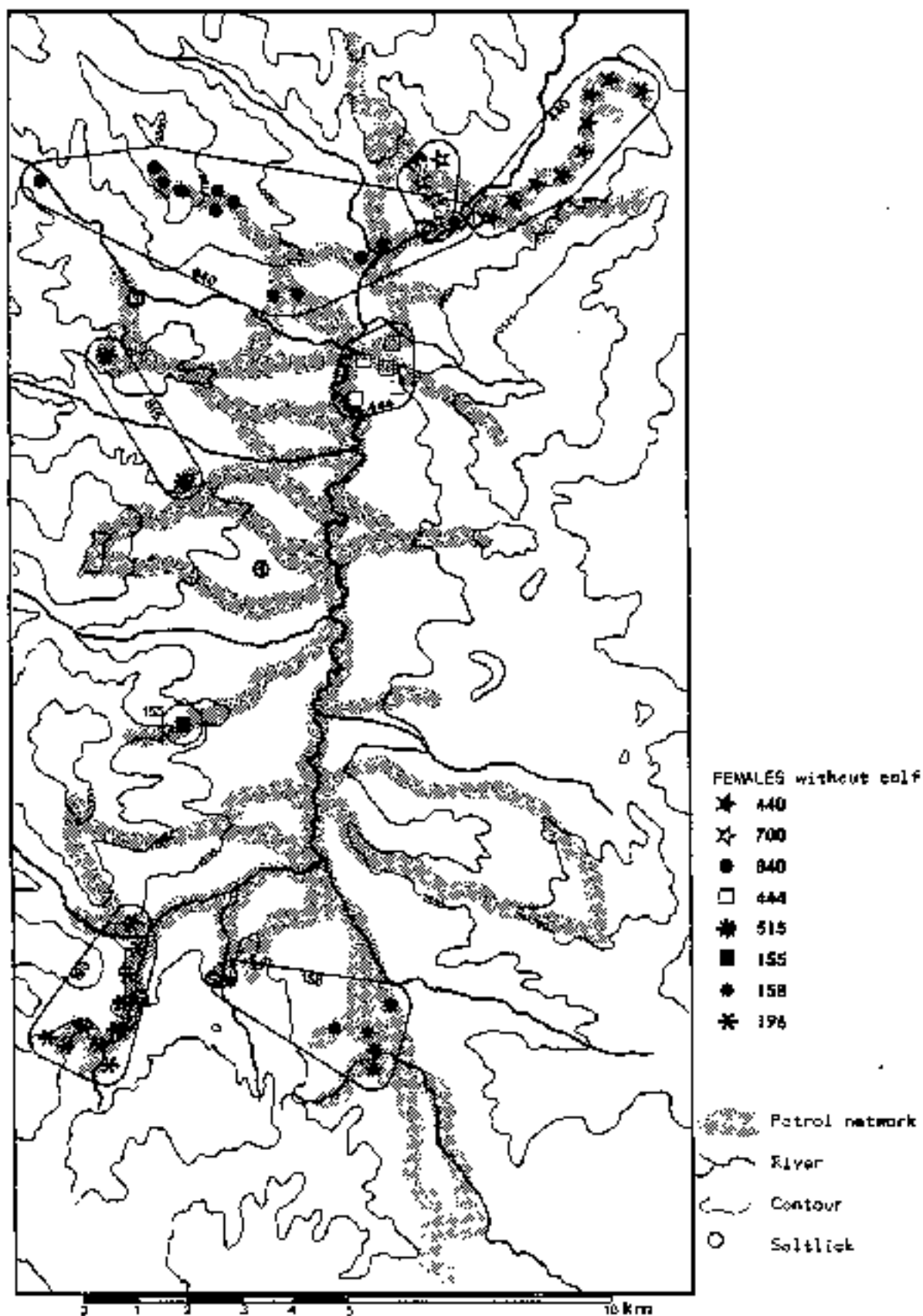

Figure 5.1 - Distribution of the breeding females in the period that they were without calf

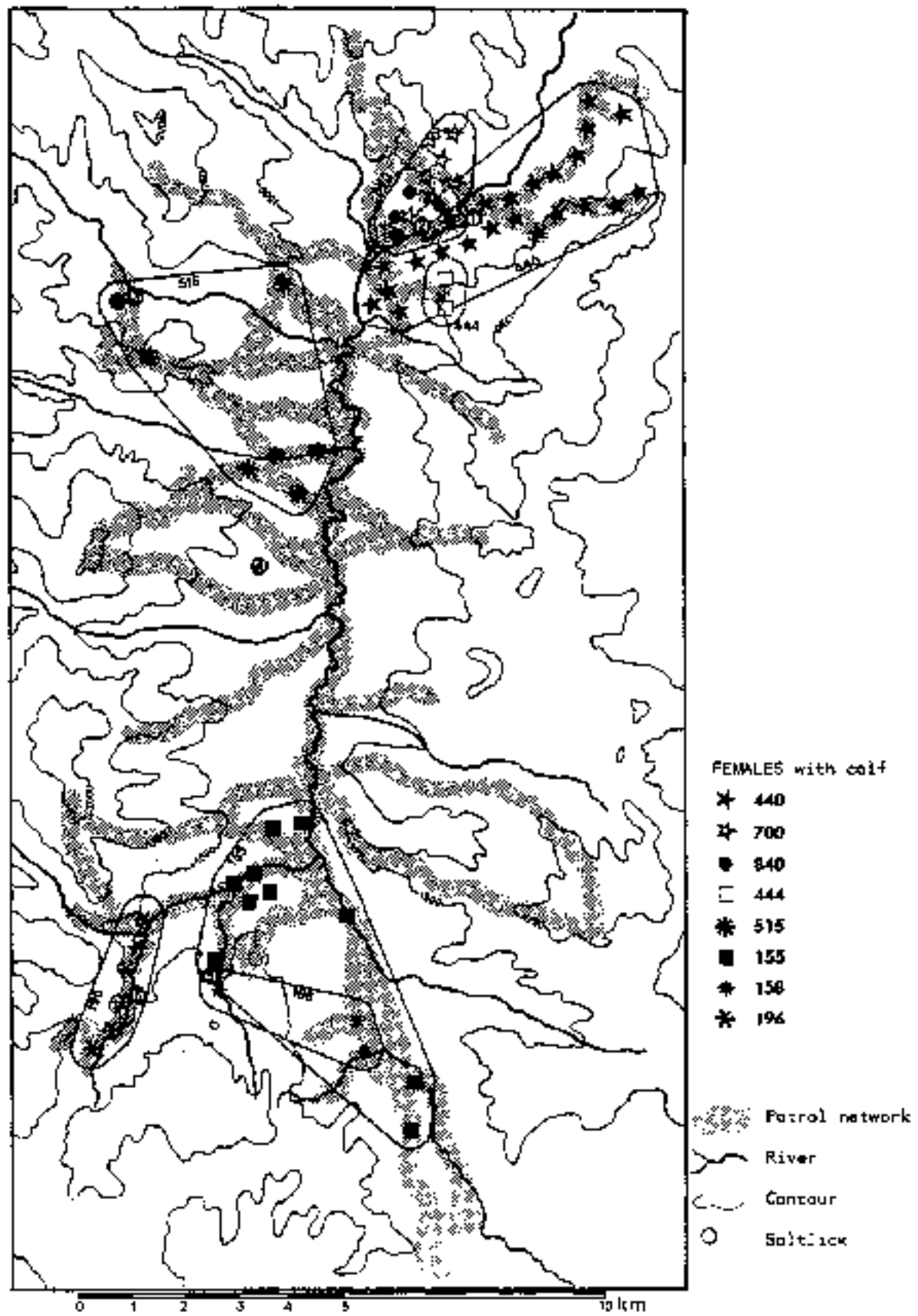

Figure 5.2 - Distribution of the breeding females in the period that they were with a calf

of the study area, but with calf they were found over a large area. Female 515 and calf 410 visited saltlick 3 and wandered over the area between that saltlick and the Mamas river. Female 155 and calf 130 frequented saltlick 3 covering an area between that saltlick, camp Pawang and camp Lukluk. Again both females appear to have their non-breeding ranges largely outside the study area, but with a calf they come down to the valley and remain in an area adjacent to the saltlicks.

Two females were found in the south. Female 196 and calf 200 were found fairly frequently, but only close to saltlick 6. They appear to originate from the mountains west of that saltlick. The records of female 158 and calf 138 are rather scanty. They visited saltlick 5 and were otherwise only found on the watershed between Mamas and Silukluk. The female presumably has a non-breeding home range in an area north of camp Lukluk, crossing the study area on the way to saltlick 5. The breeding home range is probably also largely outside the study area, possibly south and east of saltlick 5.

Calf 400 was rarely found after independence, and then only on the northern trail to the saltlick 1, and also a little further south on the west bank of the Mamas, where the cow was never found. Calf 100 was born late in the study and was still dependent at its conclusion. The young sub-adult 840 was only found around saltlicks 1 and 2 where it was also found with its mother 800. Young sub-adult 445 ranged over a rather large area, east of camp Aceh, an area it had probably also wandered with the cow.

By far the most complete records are available for the independent calf 410. After it left the cow its tracks were found on almost every expedition and generally more than once on an expedition. Its range overlaps considerably with the breeding range of its mother and most of the tracks were found along the ridge between saltlick 3 and the Mamas (Jalan A. Yani area). From the number of tracks it appeared that the animal made very intensive use of the area, walking up and down through the area. Once tracks were found, usually fresher tracks were found a few days later in the same place or nearby. This animal was regularly recorded in this area for a period of about three years, till the end of the study.

Calf 130 was after it left its mother found west of camp Pawang, along the lower Sungai Pinus and at the saltlick 5, but it was also found once at saltlick 6, where neither it nor its mother had ever been recorded before. In this case the home range of the young sub-adult appears to be located between the breeding and non-breeding ranges of the cow. Once independent calf 138 was found at saltlick 5 and further north, whereas with the cow it had appeared to reside south and east of the saltlick. Calf 200 was found on the mother's route from the west to saltlick 6, but also further downstream along the Sungai Pinus.

After separation all calves spent the first few years in roughly the same area they had wandered over with the cow. But the home ranges of the young sub-adults do not overlap completely with the breeding ranges of the females. They no longer visit some areas they had used with the cow and range into new adjacent areas, previously unknown to them.

Apart from the 8 pairs described above we found tracks of a few unassociated young rhinos, apparently born during the period of the study. This indicates the presence of still other females in the area. Based on the estimated dates of birth and the estimated breeding interval (minimal about 1500 days - See chapter 6.4) some suggestions can be made regarding the identity of the mothers of these young.

Young sub-adult 134 was found in the same area as calf 200, but since the birth interval between the two is only 630 to 860 days, it is highly unlikely that both calves had the same mother. Rhino 134 was presumed born in the second part of 1978 or early 1979, so it should have been accompanying a cow at least on expedition 15 and 16 and possibly on expedition 14, but no tracks of calves were found then. There are only two rhinos known to visit saltlick 6 from the south or west - 181 and 192. Rhino 181 cannot be the mother because this animal was found without a calf on expedition 16, but tracks from rhino 192 were found only on expeditions 13 and 14; this animal could have been the mother of 134. It was remarkable that on the 14th expedition fresh and old tracks of rhino 192 were found at saltlick 6 and also old tracks at saltlick 5, indicating that the animal had visited this place twice in a short span of time and apparently wandered away from her normal route. The distribution of the tracks of other females suggests that females might move down to the saltlicks some time prior to the birth of the calf.

Young sub-adult 135 was assumed born at about the same time as young 134, and from its tracks it seems that this animal probably visits saltlick 4 from the south. On the very first expedition a set of unidentifiable double tracks were found there, but no very small prints. This may have been a female with an older calf, already one or one and a half years old. Young 135 could be the next calf of this unknown female, because there would be at least a 1500 day interval between the births. This calf must have been accompanying a cow at least during expeditions 15 and 16, and probably also on the 14th expedition. Rhinos known to range that area include adult 195 and adult 106, cow, but rhino 106 is unlikely to be the mother, it was found only once and is probably only an occasional visitor to the area. Rhino 195 was found frequently

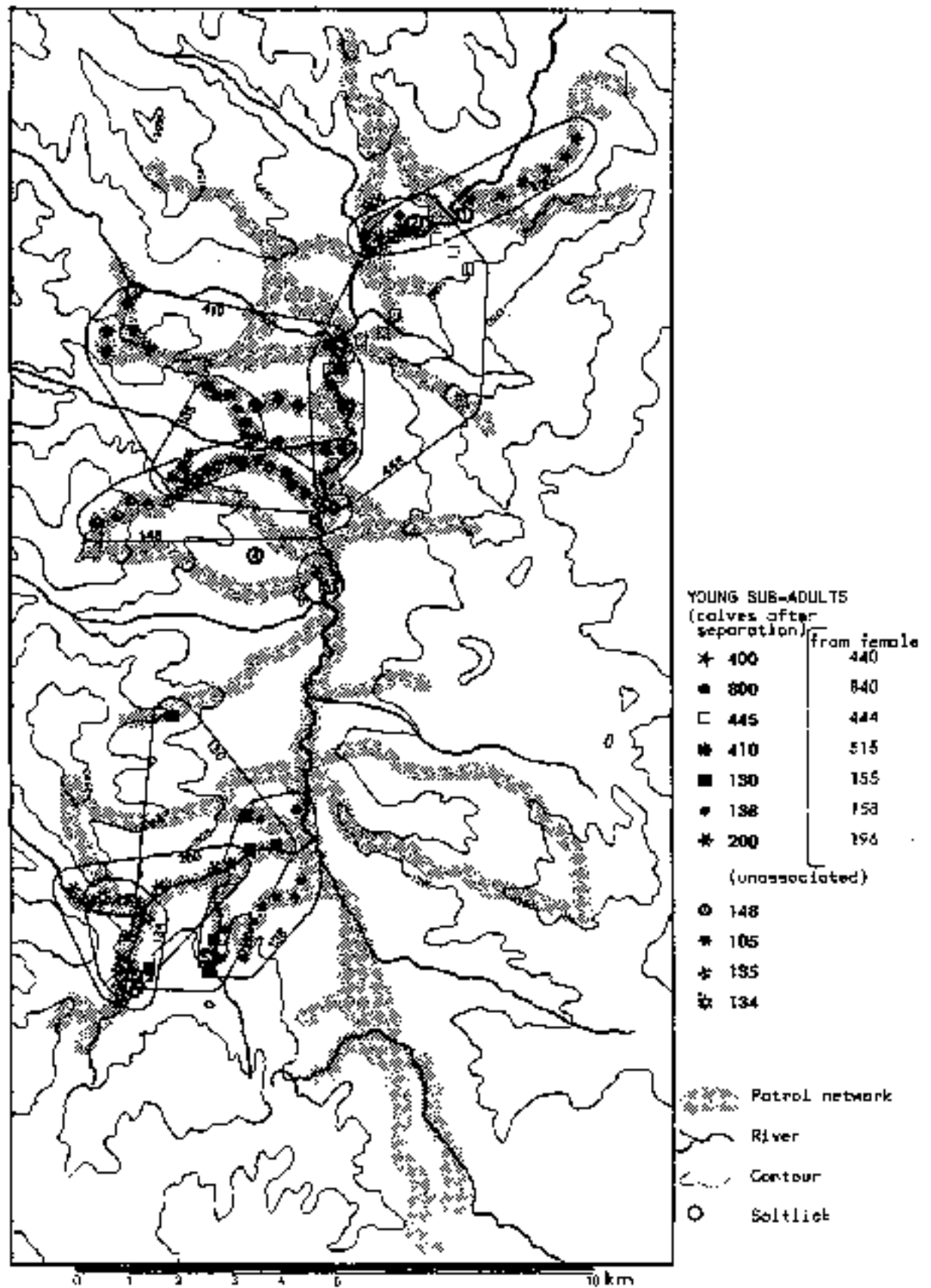

Figure 5.3 - Distribution of the calves born or presumed born during the period of the study, after they became independent from the female. The distribution of the older sub-adults, apparently born before the period of the study, is shown in figure 5.4

between the 8th and 11th expeditions and there is one unreliable record from the 17th expedition. It probably has its home range in the area north of the Sungai Pinus, from where it visits saltlick 4. With a calf it might reside in the area southwest of the saltlick, along the Sungai Niko, and be easily missed by the patrols. Sub-adult 146 could very well be the previous young, because it is found in the same area. Based on the above arguments the rhinos 192 and 195 are tentatively grouped with the females when appropriate.

Young sub-adult 148 was only found on the 16th expedition, when it entered the area over the top of the mountain west of camp Central, walked down along the trail to the Mamas and returned along the same route. From the size of its tracks it was estimated as having been born in the first half of 1977, so would probably be travelling with its mother on the 10th and 11th expedition and probably also on the 9th or 12th. None of the rhinos known to reside in the study area seems a suitable candidate for mother. The most likely explanation is that young 148 and its mother normally reside west of the study area, possibly visiting saltlicks further up the Sungai Badak, and that the young animal made a short excursion into the study area, following a big game trail.

The fourth unassociated young (105) was found twice on the 17th expedition. Its prints were very small for an independent rhino and it was concluded that it was born in early 1979 and had left the mother only recently. Because it was found in the same area as calf 410, it seems likely that this is another calf of female 515. The cow was found only once on the 14th expedition, before this calf could have been born. If female 515 is the mother to both calf 410 and calf 105 the breeding interval would have been between 1000 and 1100 days.

5.1.2 - Distribution of the sub-adults

The distribution of those animals that were classified as sub-adults (which in this chapter does not include the calves that were born during the study) is shown in figure 5.4. The first thing that strikes the eye is the absence of this category from the southern half of the study area. In the northern half these smallish prints, called "mini" in the field, were found throughout the study period, but in the southern half they were absent until the three calves born there became independent. The reason for this can only be guessed, but it might have been caused by rhino poaching that occurred in this area until the start of this study (see chapter 5.1.4 and appendix C).

In the northern half of the study area prints of sub-adults were found frequently, more regularly than the larger prints of the adults. Their ranges include both high and low land and there is considerable overlap. In general the ranges of these older sub-adults seem to be larger than the ranges of the independent calves. Tracks of two sub-adults were found on both sides of the Mamas river. For all other rhinos in the northern half the Mamas appears to be an important boundary and they were never found on both sides except very close to the river.

The saltlicks 1 and 2 are each visited by one sub-adult - 446 and 820 respectively - and saltlick 3 and 4 by two sub-adults each - 140, 460 and 146, 199 respectively. From the distribution of the calves after separation it is clear that young sub-adults remain in a rather restricted area, close to where they were nursed, for at least two to three years. It could be that during the whole sub-adult phase the rhino only very gradually extends and shifts its range, and that the older sub-adults will still be found in the area where they were nursed. This lends added weight to the suggestion made previously that rhinos 146 and 135 could be young of the same cow, because they occupied roughly the same area. From their ranging patterns it seems likely that rhino 446 could be the progeny of female 440, rhino 820 of female 700 and rhino 140 of female 515. The tracks of sub-adults 460 and 199 were intermediate in size between sub-adult and adult when first found (see chapter 4.2) and are probably older than the rest of the sub-adults, and might be even earlier progeny of one of the females mentioned above.

5.1.3 - Distribution of the males and other adults

Only four of the adults can be identified with any certainty as males (see chapter 4.3). The ranges of these four males are shown in figure 5.5. Since there are known to be 6 or possibly 10 females in the total number of 21 resident adults, it can be expected that some of the other adults are males too, if we assume a roughly equal sex-ratio. The ranges of all unsexed adults are shown in figure 5.6.

Male ranges are extensive, much larger than those of the non-breeding females. They extended over both the lower and higher parts of the study area. Male ranges show considerable overlap and males wander over a wide area.

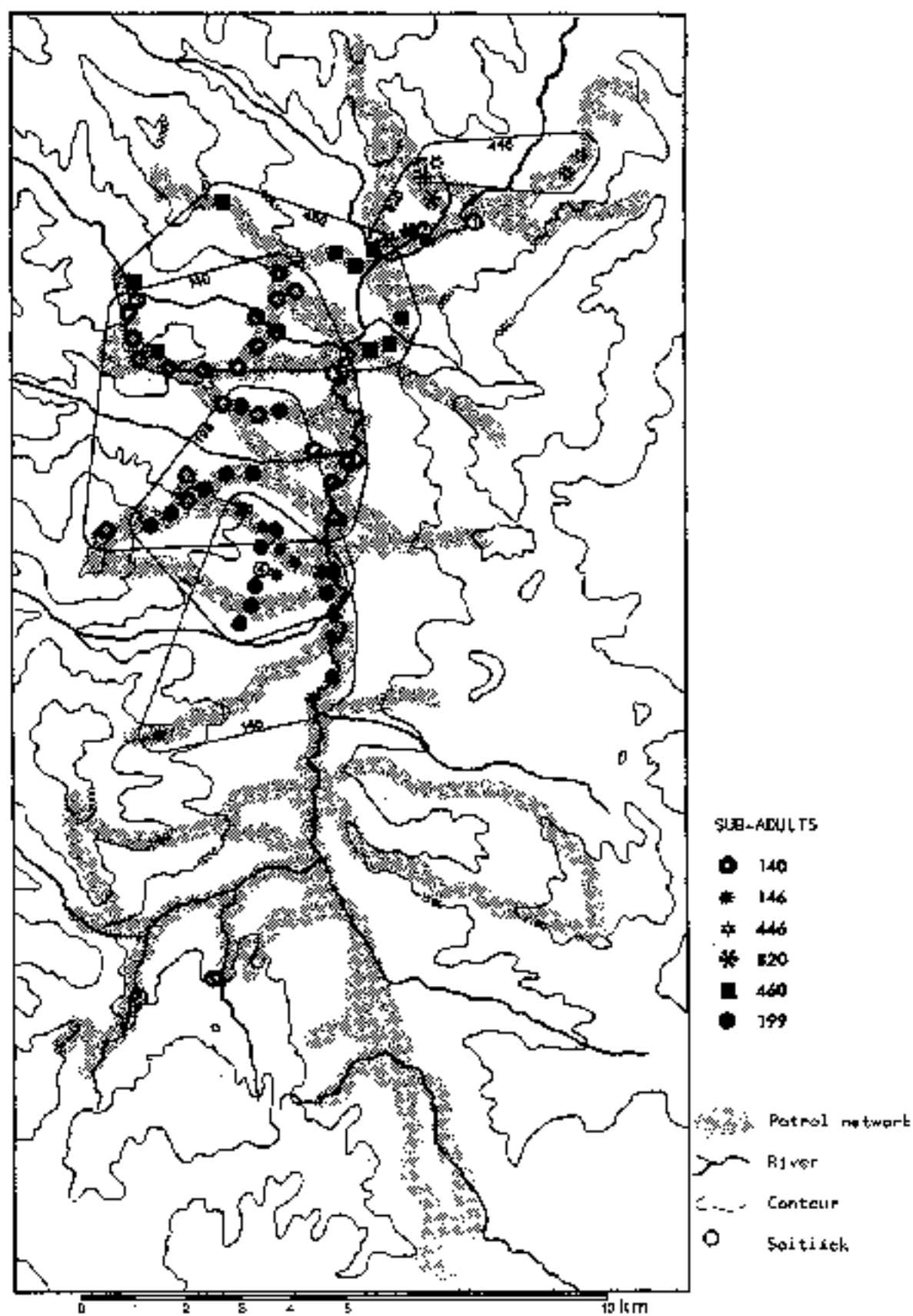

Figure 5.4 - Distribution of the older sub-adults, already independent at the start of the study

Male 520 is the most regularly recorded rhino. His tracks were found on most expeditions and often more than once in different locations. It appears that his home range covers a rather large area west of the Mamas, overlapping much of the study area. Like male 520, the other northern male - 610 - visits saltlick 3, but his range lies more to the north. The ranges of both males overlap, but male 610 appears to have a fair part of his home range outside the study area, and therefore the overlap is probably less than suggested in map 5.5. Male 610 was usually found north of the Batu Lkat river, and only on one occasion further south, near the Badak river, where male 520 is most often found.

Of the other adults in the northern half of the study area, two - 106 and 810 - seem typical of very old animals, with peculiar asymmetric prints, and both were found only once. These are probably only occasional visitors to the area, probably coming to one of the saltlicks. The tracks of the other two rhinos - 110 and 880 - were found over a large area, but there was no firm evidence that they were males, although their ranging patterns suggest this. Rhino 880 occupies an area east of the Mamas. It probably uses one of the northern saltlicks, although its tracks were never actually found there.

Rhino 110 (this rhino has a very characteristic print) shows a remarkable distribution. It was found once on the top of the mountain west of camp Central and twice more around saltlick 1 and an route thence, passing the saltlicks 2 and 3. Probably this rhino normally resides west of the study area, from where it undertakes a long journey to saltlick 1, bypassing two other saltlicks. Because all unsexed adults in the northern area have large home ranges and occasionally wander far from the centre of their home range, like the known males, they are all grouped with the males when appropriate.

The two males in the southern area - 191 and 296 - were found less frequently. Both visit saltlick 6 and probably have a large part of their home range outside the study area. Male 191 has a relatively large range, but most of this is due to one single trip the animal made from the Silukluk area, along the Tenang river, up and down the Mamas for a few kilometres and further up the Pinus river to the saltlick. More usually it approached the saltlick from the south or east, and the centre of its home range is probably south of the study area, between the Silukluk and saltlick 6. Male 296 was also found at saltlick 6 and close to the watershed between the Mamas and Silukluk. The tracks indicated that the centre of its home range is located northeast of the Silukluk, and it crosses the Silukluk area on its way to the saltlick.

Of the other five adults that were recorded in the southern half of the area, two - 195 and 192 - are probably females (see chapter 5.1.1). Another - 194 - was a regular visitor to the study area during the first two years of the study, but later vanished. The direction of its tracks suggest that it resides northeast of the Tenang river, and passes through the study area on its way to saltlick 5. The other two animals are occasional visitors, rhino 181 comes to saltlick 6 from the south and rhino 156 has been found a few times in the Silukluk and Tenang areas. Since the distribution of tracks of these three animals did not give sufficient information to sex them, all three were tentatively grouped with the males.

5.1.4 - The overall distribution patterns

The distributions of the individual rhinos, as described in the previous chapters, clearly show that each rhino has a fairly well defined home range that includes a saltlick. Figure 5.7 shows the home ranges of known individuals. For some individuals the range is well known, for others it can be deduced from occasional tracks and direction of travel; for a few animals there is too little information to deduce anything other than an approximate locality for the animal's home range. Most rhinos were actually recorded at one of the saltlicks. Some were found nearby or walking towards a lick. The saltlicks are also shown in figure 5.7.

From the distribution map (figure 5.7) it seems that rhinos were absent from the area east of the Mamas in the central part of the study area, apart from north of camp Central and in the Silukluk area where a few rhinos were found in the mountains east of the Mamas. Most individuals were found west of the Mamas-Silukluk valley (30 of 39). In fact the area east of the Mamas was visited by rhinos, but good tracks were never found. Old faeces were occasionally found, but rhinos seem to use the area infrequently.

Although the area east of the Mamas is rather steep, it is not unsuitable for rhino, and there are well-developed rhino trails on all the major ridges, as elsewhere in the study area. But the trails were obviously very little used, overgrown at places, and the wallows had not been used for a long time. The trail system indicates that the area was used regularly by rhinos in the recent past. Their disappearance in recent years is doubtless caused by trapping on the Alas side of the mountains. Rhino traps were found close to camp Pawang in 1975 (see appendix C) and old signs of poaching were numerous on the slopes facing the Alas valley. Only in the north of the study area are rhinos safe east of the Mamas, because the escarpment there is extremely rugged and steep.

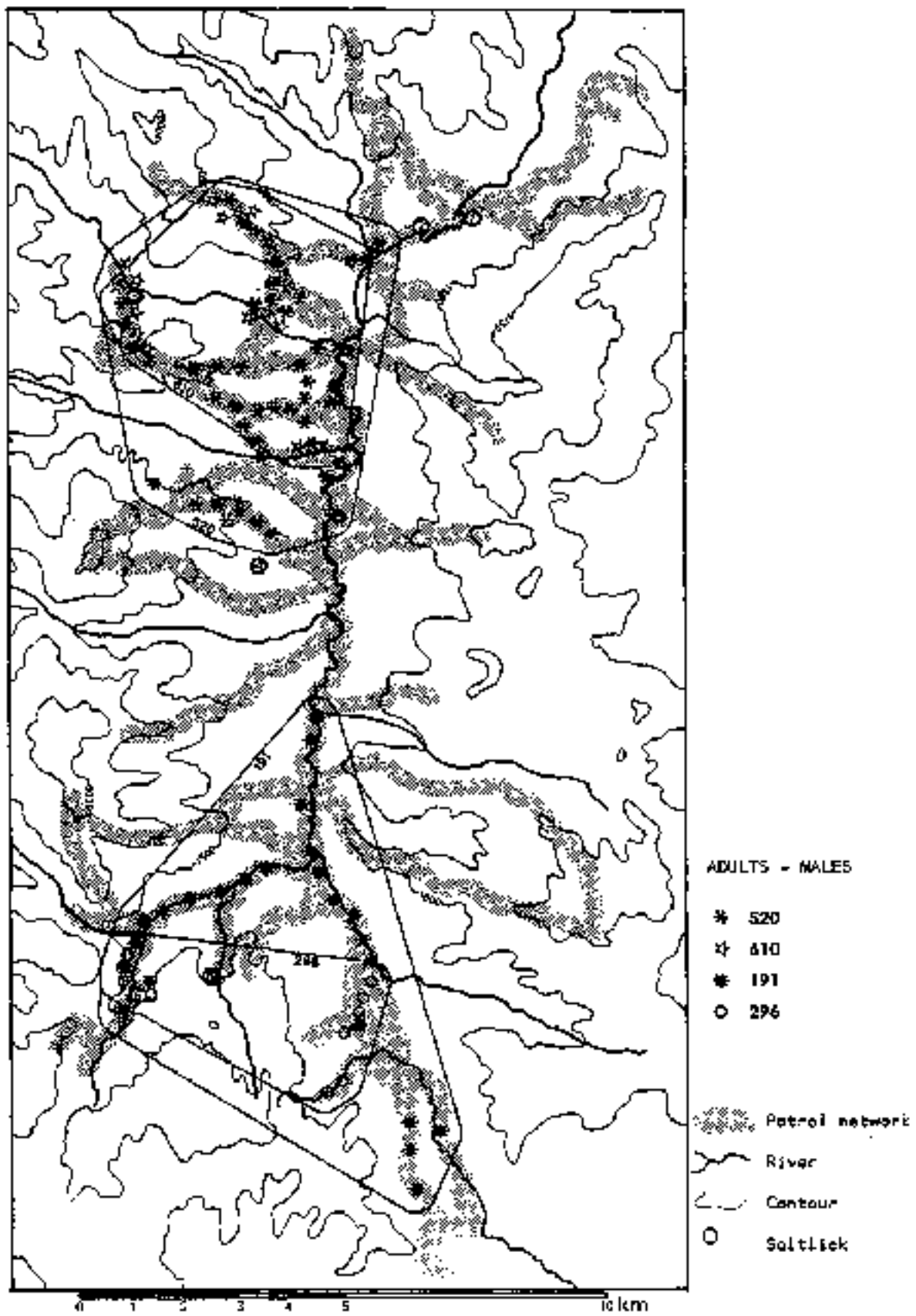

Figure 5.5 - Distribution of the adults, identified as males

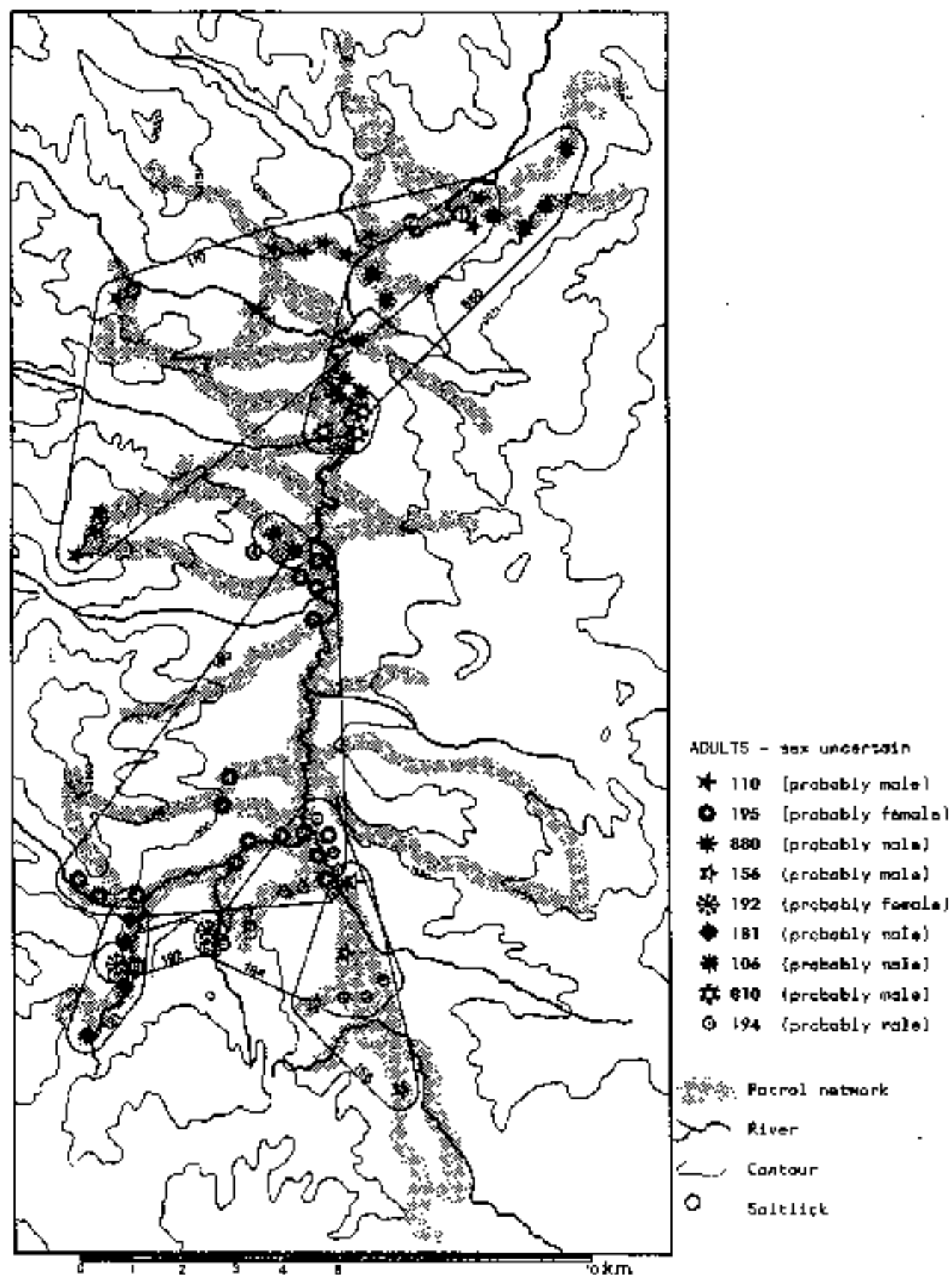

Figure S.6 - Distribution of the unsexed adults. Two are probably females, seven are probably males

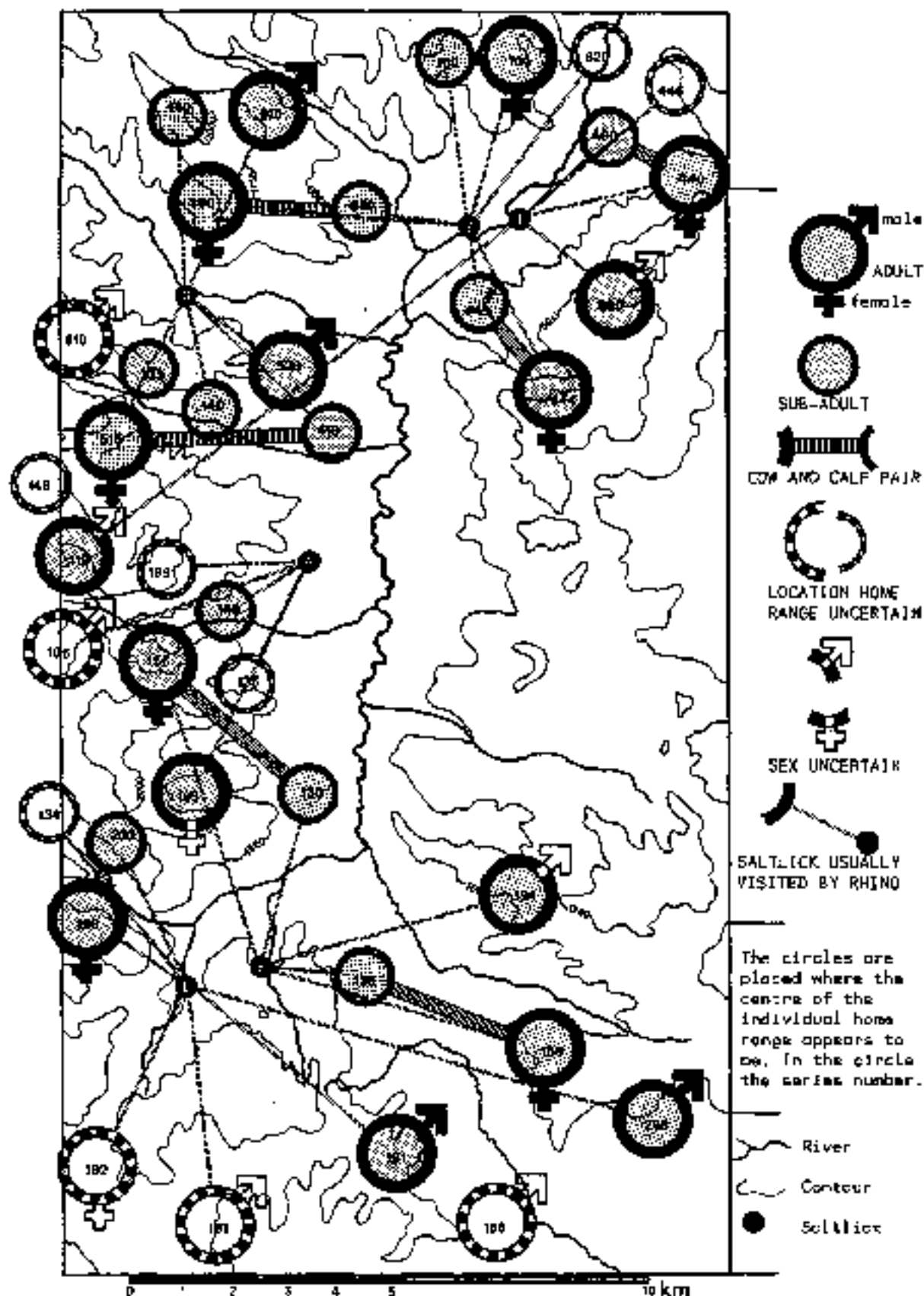

Figure 5.7 - Distribution of all identified rhinos. The circles are placed at the assumed centre of the home range

If we compare the northern and southern halves of the study area, taking the Sungai Niko as boundary, some differences in the distribution of individuals are apparent. Sub-adults are absent from the southern area and the total number of rhinos seems to be less there. 23 individuals were using the area north of Sungai Niko but only 16 were found in the south. These differences in numbers are probably also attributable to poaching. On the ridges south of the study area and in the area around saltlick 6, rhino trapping was practised for many years and as recently as 1974, and a fair number of rhinos must have been killed there. This could also explain the absence of sub-adults in this area. Females with calves and young rhinos remain close to the saltlicks and since traps are often placed on the big trails leading to the licks, they probably run a greater risk of being killed than the other rhinos, which go there less frequently.

The saltlicks appear to play an important role in the life of the rhino. The calves are born and raised in the surroundings of the saltlicks, and stay in the neighbourhood for some years. All rhinos pay regular visits to a particular saltlick, often travelling long distances to reach it. Tracks of 30 of the known individuals were found at saltlicks and only four individuals were never recorded close to a saltlick. Most animals seem to regularly visit one saltlick and only a few rhinos were recorded at more than one lick; in most cases these animals were males (see chapter 6.2). Travelling to or from a saltlick rhinos usually stick to one, but occasionally more, regular tracks; and in several cases rhinos visited a saltlick which was not the one nearest to the centre of their home ranges. The rhino home ranges serviced by each of the saltlicks overlap. It could be that rhinos normally visit the same saltlick throughout their lives and that most of the animals visiting a particular saltlick are related. The frequency of the visits to the licks will be further discussed in chapter 5.6.

For almost all the rhinos the Mamas river seems to be an important boundary. From the range maps in the figures 5.1 to 5.6, it is apparent that all but two animals (sub-adult 460 and sub-adult 446) are found exclusively on either the west or the east side of the river, although a few animals cross to the further bank but do not move away from the river. The other rivers and streams in the study area do not seem to act as a boundary.

The Mamas river is certainly not a physical barrier to rhino movements. Normally when a rhino descends to the river it enters the water, swims or wades to the other side, and often follows the river for some distance, crossing several times, but it almost always returns to the side from whence it came. Sometimes short visits are made to the opposite banks, but the animal generally quickly recrosses. A big river may be an important landmark for a rhino, determining part of the boundary of its home range (see also chapter 7.2).

The non-breeding ranges of the females all seem to be located at the margins of the study area, on the higher slopes of the mountains. This is also true for the ranges of most males and other adults. Only a few sub-adults have home ranges more to the centre of the study area. This is probably an artefact of the study area's location besides the Mamas river. This river forms the boundary of the home ranges of most rhinos, and therefore lies at the periphery of their extensive home ranges. If the study area had been centred on a major watershed, then it would probably have encompassed the main centres of distribution of the adult rhinos, but we would have found few tracks of young animals, which are found mainly at lower levels near the river.

Young and sub-adults range mainly on the lower slopes of the mountains, closer to the river, and to the saltlicks. The adults spend most of their time away from the licks, with the centre of their home ranges on the major ridges. The distributions of the non-breeding females and the males seem to differ. Tracks of the males were found frequently and virtually everywhere in the study area, in the higher and lower parts alike, and males have large home ranges that overlap extensively. Tracks of non-breeding females were rarely found in the study area and the non-breeding home ranges seem to lie on the higher parts of the ridges, with individual home ranges rather restricted and well separated from the ranges of other females. Centres of both female and male home ranges seem to be rather evenly distributed over the area.

Females seem to show a strong spacing mechanism. In non-breeding condition they use strictly separated home ranges, but with a calf they are less exclusive. The males do not avoid one another's home ranges, but it may be that there is only peripheral overlap of the extensive home ranges, and that the core areas are more clearly separated. Young sub-adults appear to occupy mainly the marginal parts of the home ranges of the adults, and gradually expand their range with time, gradually moving away from the lower slopes and saltlicks where they spent their infancy.

5.2 - Analysis of the individual ranges

To analyse the extent of individual home ranges detailed large-scale distribution maps were made for all the rhinos; a selection is shown in figures 5.8 to 5.11. The course and direction of each track is shown by the thick solid lines, and tracks made during the same expedition are, whenever possible, connected by dashed and dotted lines to indicate the presumed course of travel. Dashed lines indicate unidentified tracks if these are believed to have been made by the same rhino. The dotted lines connect successive tracks of the same rhino and indicate the animal's probable route. Wallows used by individual rhinos are indicated by solid circles.

Range size was measured by drawing a polygon enclosing all recorded tracks. Straight lines were used except where the Mamas river was known to form the boundary. There the approximate course of the river was used as the boundary line. If the direction of the tracks suggested that the rhino had ventured outside the polygon, this is shown by the short fat arrows.

The maps presented in figures 5.8 to 5.11, show the ranges of animals from different age and sex classes. No ranges are included for rhinos that were found only once or twice, animals found only in a small area on their way to a saltlick, or whose tracks were found only infrequently.

There are a few factors complicating the estimation of the size of the home range of the individual rhinos. The irregular and localised occurrence of the tracks of many of the rhinos in the study area, suggests that most animals spend only part of their time in the study area. The range of an individual as shown by its tracks recorded during the study therefore represents only a part of its home range, but it is difficult to estimate how large a part that is. For the estimation of the average size of the home range for each category the ranges of the most frequently recorded rhinos have been used.

5.2.1 - Female home ranges

As has been explained previously females in non-breeding state use different ranges to when they are accompanied with a calf. Females with calf were found comparatively often in the study area, usually close to a saltlick. Outside the breeding period the females were found much less frequently and on the higher slopes, where they have relatively small ranges, which do not overlap with those of other females.

Because of the limited number of records of non-breeding females, sizes of home ranges are difficult to estimate. But the range of a non-breeding female is certainly comparatively small, much smaller than the range of a male; otherwise the rarity of records of non-breeding females cannot be explained. The non-breeding home range is probably not more than 10 to 15 sq km, perhaps even less, with the female using a regular corridor to a saltlick.

Much more records are available for females with a calf. The home range of the pair is about 10 to 15 sq km, and adjacent to the saltlicks. Because of the shifts in home range in relation to the breeding cycle, the total home range of a female (throughout the breeding and non-breeding periods) is fairly larger, but only part of it is used at any time. For one well-known female the "overall" home range was about 20 sq km. For other females figures cannot be given, but all appear to have relatively small home ranges, clearly smaller than the males' home ranges (see chapter 5.2.3). The average home range of a female rhino was estimated to be 20 sq km.

When a female visits a saltlick, her tracks are generally easy to follow. Often her tracks to and from the lick follow a direct route. Occasionally a few short detours were made around the lick, but the animal's trails of approach and departure were easily found. Unlike males, females do not make extensive explorations in the environs of the lick; they simply ingest minerals and leave again. Non-breeding females seem to be very conservative in their choice of route to the saltlick, and they use the same route each time they travel to the lick. When accompanied by a calf they may approach the lick from several different directions.

The following examples will illustrate female behaviour. Three females - series 700, 440 and 196 - were found fairly often without calf, but invariably on a specific route to one of the saltlicks, and their ranges are illustrated in figure 5.1. The rhinos 440 and 700 used exactly the same routes to approach and leave the saltlick every time, generally not deviating more than a few steps from their previous track. Since all the records for these females follow one line their known ranges are very small (0.2 to 3 sq km). Female 700's tracks were found only in the last kilometre of the corridor the animal travelled to the saltlick.

Four of the females were found very seldom outside the breeding period, and their known non-breeding ranges are also very small (1 to 3 sq km). Female 158, found once at saltlick 5 and twice in the Tenang - Silukluk watershed has her home range probably north of the Silukluk river. Female 444, was recorded three times in a small area east of camp Aceh. Female 155

was found only once and female 515 twice, three kilometres apart. The ranges of all these females are shown in figure 5.1.

The only female that was found over an extensive area during the period when she was without a calf, is female 840. She ranged over an area of almost 12 sq km in the Jajan Sudirman area, west of camp Aceh, and up to saltlick 1. A map showing all the tracks of this female is shown in figure 5.9C. This rhino was found once outside the study area upstream from saltlick 3, once at saltlick 1 and further west along the ridge. Again it appears that a fair part of this range is made up of the corridor to the saltlick, and that a fair part of the home range is outside the study area. The centre of the home range of this rhino is probably located somewhere around the mountain top at the end of the patrol trail, but it is difficult to estimate the extent of the home range.

The scarcity of records for most of the non-breeding females makes estimation of the average non-breeding home range very difficult, but it is apparently a relatively small area, no more than 10 to 15 sq km, part of which covers the corridor to the saltlick.

During the periods when the same females were with a calf more records are available. When the females have a calf they come down to the saltlicks and remain in a rather small area adjacent to the lick. One female - 444 - was found only once with a calf. Four others - 700, 158, 196, 840 - were found only very close to the saltlick, and their breeding ranges apparently fall also outside the study area (see figure 4.2). Three females used the study area fairly extensively.

From records collected on four expeditions over almost one year the range of female 515 and calf 410 was found to cover almost 11 sq km (see figure 5.2). No indications were found that the animals had been far outside the polygon and the breeding home range is probably not very much larger.

The distribution of the tracks of female 440 and calf 400 are shown in figure 5.9B. This pair was found on four successive expeditions and their tracks could be followed for relatively long distances. Their range covers a longitudinal area of over 9 sq km on the slopes east of the Mamas. The tracks of this pair were mainly found travelling to or from saltlick 1, but once they were found walking south along the slope and within a few hundred metres of the saltlick. Going to the saltlick they used several different routes, not only the route which the cow used regularly before the birth. The tracks indicate that the range is probably more extensive to the north and northeast but the animals were frequently found in the study area and the range shown in the map probably covers most of the animal's actual home range.

Female 155 and calf 133 were found on five successive expeditions, four times with fresh tracks. Their total range might be somewhat larger than the figured area of almost 13 sq km (figure 5.10B), but not much, because the animals were frequently found in the study area.

Based on these three examples of rhinos whose breeding ranges largely overlap the study area it can be concluded that a female rhino with a calf, has a home range of 10 to 15 sq km, adjacent to a saltlick.

For female 155 the 'overall' home range was substantially larger (15.9 sq km) than her range with young (12.9 sq km). For other females the total range is only slightly larger than the breeding range. Female 155 was found five times in succession with her calf, but outside this period she was found only once at the western boundary of the study area, about 5 kilometres north of the centre of the breeding range. It seems that this female, when not nursing, travels mostly outside the study area and that it migrated several kilometres south to nurse its calf. Its home range may therefore be as large as 20 sq km, but the animal uses only part of it at any one time.

Similarly female 515, seems to reside at the periphery of the study area, when not with calf. Other females, like 840 and 196, show smaller range shifts and their total ranges may be smaller. The home ranges of the females are considerably smaller than those of the males, which can be 25 sq km or more (see chapter 5.2.4). The average home range of a female rhino, breeding and non-breeding together, is estimated to be about 20 sq km.

In this context it is worth considering the distribution of adult 195, as shown in figure 5.10C, as this rhino may be a female and the mother of calf 134. This rhino probably visits saltlick 4, because it was never found at the southern saltlicks, although it was often found nearby at Sungai Pinus. Its range is more than 20 sq km, but this can be attributed to one single track found close to camp Central and saltlick 4. All other tracks of this animal were found along or close to the Sungai Pinus. It could very well be that this rhino resides normally along the ridge north of the Sungai Pinus, travelling a rather long corridor to saltlick 4. After the birth she may have migrated to the area south or west of this saltlick; an area that was not very often patrolled. In general the pattern of distribution shown by this animal does not contradict the pattern described above for females, and this rhino could indeed be a female.

5.2.2 - Home range of the calves after weaning

In chapter 5.1.1 we saw that the calves, after having separated from the mother, remain in the area where they were nursed for two to three years, and gradually extend their range by venturing into adjacent areas. These young subadults have a home range of about 15 sq km, with a corridor to a saltlick.

One of the calves - 100 - was still with the cow at the end of the study. For four others - 200, 400, 800, 138 - only scanty records are available, but for three young sub-adults good sets of tracks were found over their first few years of independent life. By far the most frequently recorded young sub-adult is rhino 410, calf of female 515 (see figure 5.9D). Fresh tracks of this rhino were found on six of the seven expeditions made after it became independent. Its range covered almost 14,5 sq km, but most of the tracks are located in the eastern half of the range. It was found only once at saltlick 3 and it apparently does not use the big trail leading down from the ridge, but takes a more southern route to the lick; a route it probably used with its mother.

The home range of this rhino should probably be extended somewhat to the southwest and might be a little over 15 sq km. The western and less used part of the home range is formed by a corridor to saltlick 3, following the Sungai Badak, before turning north to the saltlick.

Another young sub-adult - 445, calf of female 444 - was found on the opposite side of the Mamas using an area of 11,6 sq km (Figure 5.9R). Although the eastern side of the Mamas was less regularly patrolled, this rhino was found on three successive expeditions, once over a rather large area. Although records are fewer than for calf 410, the home range of this rhino is probably not much larger than the range shown in figure 5.9E.

In the southern half of the study area one of the young sub-adults - 130, calf of female 155 - was found ranging over an area of 9,6 sq km (Figure 5.10A), on both sides of the Sungai Pinus. Its range would become considerably larger (almost 15 sq km) if an unreliable record on the high mountain top north of camp Pinus is included. It is remarkable that this rhino was found on one occasion at each of the southern saltlicks. On that expedition one of the rare visitors to the Sungai Pinus saltlick - rhino 192 - was also found at both licks, so it could very well be that calf 130 followed the older trail of rhino 192 to the other lick.

Young sub-adult 400 was also once found at saltlick 2, whereas with its mother it had always visited saltlick 1, and never crossed the Mamas (see figure 5.9B). This suggests that young sub-adults are exploratory and venture into new areas, thus gradually extending their range. This could also explain the sudden appearance of a new young sub-adult - 148 - on the 16th expedition (see figure 5.3), in an area that had been regularly patrolled before. The rhino came over the mountain top west of camp Central and descended to the Mamas along one of the big trails. After a few short detours close to the river it returned the same route and left the study area over the mountain top.

5.2.3 - Home range of the other sub-adults

Six rhinos were classified as sub-adults from the size and form of their prints. Records for most of these are scattered over time as well as in space (see the table of occurrence in figure 3.28). The fact that their tracks were not found on every expedition but at infrequent intervals made identification of the tracks more difficult. The tracks were often also found at scattered locations over a large area, as can be seen in figure 5.4. In general the older sub-adults appear to have large ranges, 20 sq km or more, consisting of a small well-used core area and an extensive and less-used peripheral area. The average home range of an older sub-adult rhino is estimated at 25 sq km.

The most regularly recorded sub-adult is rhino 140, whose distribution is shown in figure 5.8C. Its range in the study area is 18,7 sq km, and it probably extends further in northern and western directions. A concentration of tracks was found east of saltlick 3, while in the eastern and southern part of the range the records are more scattered. This rhino's range seems to include a core area east of saltlick 3, surrounded by a wider zone, which the animal uses only occasionally. Rhino 140 was found less regularly than adult male 520, who uses the same area, and probably spends more of its time outside the study area than does rhino 140. The home range of rhino 140 is probably larger than the range shown in figure 5.8C, and might be as much as 20 to 25 sq km.

Another sub-adult - 460 - was occasionally found in the same area. It was encountered at long intervals and the locations are scattered (see figure 5.4). Its range of 12,6 sq km probably only covers a peripheral area and its core area may be outside the study area, probably

further west. West of camp Central two more sub-adults were found, using saltlick 4. Both show the same type of distribution as rhino 460, and both apparently have the centres of their home ranges at or beyond the western boundary of the study area. The range of rhino 146 covered an area of 10.3 sq km (see figure 5.4).

The range of sub-adult 199, an animal found only twice near camp Central, is shown in figure 5.11A, mainly to show that this rhino visited the saltlick twice within a few days. Sub-adults 446 and 820 are poorly known. They visit the northern saltlicks, but were only found once or twice, so that nothing can be said about their home ranges. They probably reside north of the study area.

In summary it can be said that sub-adults appear to have large ranges, consisting of a core area and extensive and less-used peripheral zones and one or more corridors to a saltlick. In essence the ranges of older sub-adults are more similar to the ranges of males than to those of females; this may indicate that most of the recognised sub-adults are in fact young males, but there is no other evidence to support this assumption. If sub-adult females have ranges comparable to the ranges of the non-breeding adult females, comparatively small areas higher on the slopes, they are less likely to be found. Some of the rarer sub-adults, like 446 and 820, may in fact be females, but it is also possible that they are only occasional visitors to the study area. During the whole study 12 calves were born, but only 6 older sub-adults could be recognised; this apparent rareness may arise from a distribution of some of the sub-adults that is similar to the distribution of non-breeding females and from the difficulty of distinguishing between the tracks of different individual sub-adults.

5.2.4 - Male home range

As has been explained in chapter 5.1.3, the rhinos that were thought to be males, have extensive ranges, especially compared to those of the non-breeding females. A few males are among those rhinos most frequently encountered in the study area. Their home ranges appear to consist of a core area (where their tracks are most frequently found), surrounded by a wide zone that is less frequently visited. Male home ranges are large, 25 sq km or more. Males visit saltlicks, but usually do not travel only on one specific corridor, they often stay close to the lick for some time, foraging in all directions. Occasionally other saltlicks may also be visited. The average home range of a male rhino was estimated to be 30 sq km.

Of all the rhinos the tracks of male 520 (see figure 5.8A) were by far the most frequently encountered throughout the study. This rhino was found during 13 of the 17 expeditions, and often more than once, with fresh tracks on 9 expeditions. This rhino's home range seems to overlap almost completely with the study area.

The range over which this series was found is almost 24 sq km, west of the Mamas river to saltlick 3. The direction of the tracks indicated that on the west and southwest side the rhino had been outside the supposed boundary of the range. This rhino was most frequently found in the centre of its range or near the saltlick, and its total home range is estimated to be between 25 and 30 sq km.

Most tracks of male 520 were found along the ridge between the Sungei Badak and the Sungei Batu Ikat, in the Jalan A. Yani area, and on the trail leading down from this ridge to the saltlick. But apparently this rhino also follows other routes to the saltlick. The Mamas and some of the smaller tributaries to a lesser extent, seem to serve as boundaries. On several occasions the rhino turned back at the Sungei Badak or the Sungei Batu Ikat, but in other instances these rivers were crossed and tracks were found on both sides. It appears that the core area of the home range covers the eastern two-thirds of the ridge between camp Aesh and saltlick 3. All tracks found in the west of the range led more or less directly to the saltlick, while in the eastern half the rhino travelled in various directions.

The range of the other northern male, rhino 610 is shown in figure 5.8B. It is only 15.7 sq km and completely overlaps the range of 520, but the tracks seem concentrated in the north and especially in the northwestern corner (Jalan Sudirman) and at the saltlick. The tracks to and from the saltlick lead to the west and this rhino was once found south of the Sungei Batu Ikat, when it followed the big trail from the saltlick to the Jalan A. Yani and proceeded almost to the junction of the Sungei Badak and the Mamas.

Male 610 was less frequently encountered than male 520 and the core area of its home range appears to be north of saltlick 3, partly outside the study area. If the centre of the animal's home range is situated almost on the boundary of the study area, we can expect that there is another 10 to 15 sq km of its home range outside the study area. The home range of male 610 would then be similar to the home range of 520, between 25 and 30 sq km.

Although the ranges of both males seem to overlap completely, the core areas (the areas which the animals use intensively) appear to be separated. Male 520 has only been found once along the Jalan Sudirman, while male 610 only once ventured east over the Jalan A. Yani. The two rhinos are only regularly found using the same areas at saltlick 3 and along the Sungei Batu

Ikac. Rhino 610 has a very large and characteristic print, that can even be recognised in the field, and the Jalan A. Yani was the most intensively patrolled area. If this area is regularly visited by this rhino its tracks would certainly have been found there more than once. From the saltlick male 610 walked along the very well-worn trail uphill, probably following a track of one of the sub-adults (140). Rhino 610 travelled east, not following the main trail, till it almost reached the Mamas and returned along the Sungai Badak.

For the two males resident in the southern half of the study area only the distribution map of series 191 is given. For the distribution of male 296 see figure 5.5. In the study area this rhino has a small range of only 8.6 sq km, presumably largely formed by its corridor to saltlick 6, over the watershed between the Mamas and Silukluk rivers. The centre of its home range is believed to lie north of the Sihukluk river.

The distribution of male 191 is shown in figure 5.10D. With a range of 28.7 sq km it has the largest range of all the rhinos resident within the study area, but almost all of this range can be attributed to one extensive tour recorded on the 4th expedition, when rhino 191 followed the Tenang river downstream and along the Mamas for a few kilometres. The animal then returned and followed the Pinus river upstream to the saltlick. The animal apparently moved rapidly, because tracks were of about the same age all along the route. About 10 days later fresh tracks of the same rhino were found in the Silukluk area, very close to where it started its tour. The whole round measured at least 22 kilometres. Later this rhino was found once more in the Silukluk area and several times at saltlick 6, generally coming and going in southern or eastern directions.

Although the evidence is far from conclusive, the location and direction of the tracks indicate a home range in the triangle between the Tenang, Silukluk and Pinus rivers, with the core area probably somewhere near the southern boundary of the study area. That an animal can cover an area of this size in one rapid sweep suggests that the estimated total ranges of the males, as based on series 520 and 610, are probably still too small and that other males may also travel farther afield. If rhino 191 were to make similar trips south to the Sungai Kom-pas area, its total range could be something in the order of 50 to 60 sq km. Indeed males may wander over such large areas during their entire adult life, but for the duration of the study an estimated male range of 30 sq km seems appropriate.

Typically males seem to make long excursions into areas that are otherwise rarely used. None of the females showed such behaviour (see chapter 5.2.1). Both males in the northern half of the study area were frequently found at saltlick 3, but both were also found very close to saltlick 2 and male 520 probably also visited saltlick 4 (see also chapter 6.2). Males may regularly visit two or more saltlicks.

The male habit of making quick sweeps through the peripheral parts of their home ranges may explain the appearance of those rhinos that were only found once or twice in the study area. The most notable example is rhino 810 (see figure 5.6). The highly characteristic footprints of this rhino were found only once in a well-patrolled area at the Mamas river. This rhino must occupy a home range almost entirely outside the study area, but probably made a quick excursion westward after visiting a saltlick along one of the side-rivers. The same could be argued for series 106 (see figure 5.6), another lower found once close to camp Central. The behaviour of these two animals suggest that they are males.

Similarly rhino 110 has very characteristic prints and was found with certainty on three expeditions, over a large area (see figure 5.9A). Its range in the study area covers more than 22 sq km and it has the greatest linear extension, almost 13 kilometres. During the 13th expedition its tracks were found over a large area between saltlick 1 and saltlick 3. It apparently visited first saltlick 3, wandered downstream along the Batu Ikat river and proceeded north to saltlick 1. Here it wandered around extensively, visiting the saltlick at least three times in about one week and finally returned, following the Mamas and going on in the direction of the Jalan Sudirman.

Later this rhino was found once more at saltlick 1, again wandering about in the surroundings. Much further south it was found once on the top of the mountain west of camp Central. There is a doubtful record from near camp Central, that would almost double the animal's range if included. The long trek, visiting two saltlicks in succession, and the animal's behaviour, wandering about around the saltlick, indicate that this rhino is a male. The core area of its home range must be somewhere west of the study area, probably in the upper reaches of the Badak river.

The range of adult 194 is shown in figure 5.11B, because it is a good example of a rhino that apparently only passes through the study area on its way to a saltlick. Its tracks were found twice heading for saltlick 5 and twice at the junction of the Tenang river and the Mamas. The core area of this animal's home range must be more to the northeast, and this rhino may have made the unidentified tracks that were occasionally found along the entrance route.

Generally when males visited a saltlick, there were prints all over the place. On all trails leading to the saltlick there were tracks going up and down, and it was often very difficult to find out where the rhino had come from or where it went. Males apparently wander around extensively in the neighbourhood of a saltlick, following all major trails for some distance and coming back several times to the lick, whereas females approach and leave the lick directly.

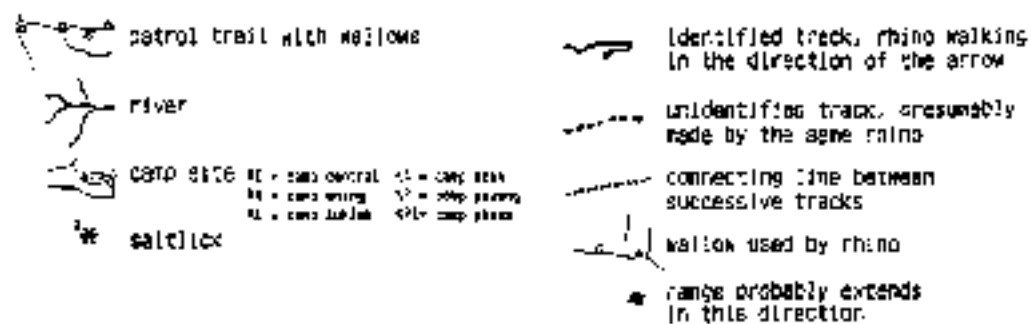
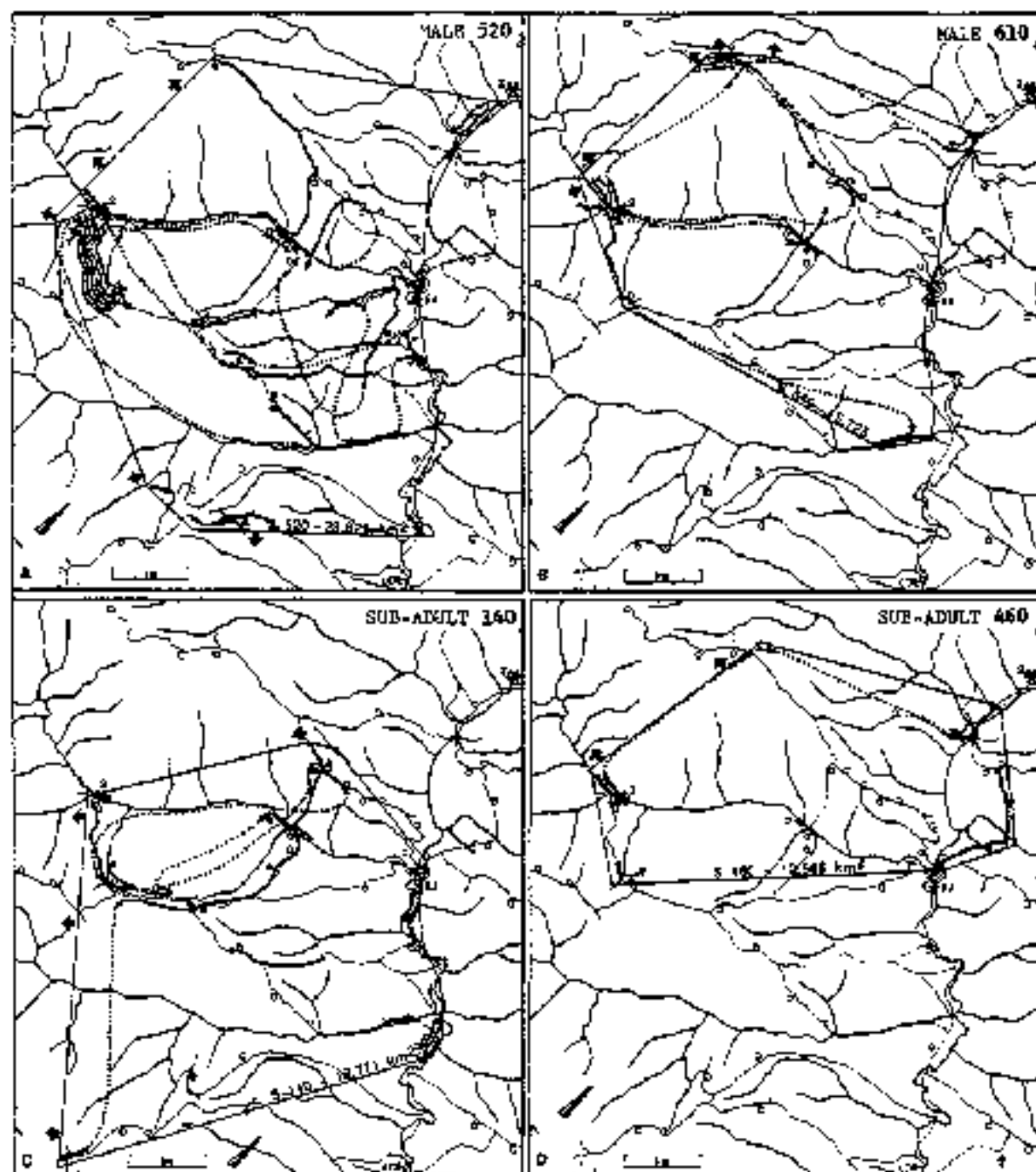

Figure 5.8 to 5.11 - A selection of detailed distribution maps of individual rhinos. The course and direction of each rhino track and the willows used by that rhino, are shown.

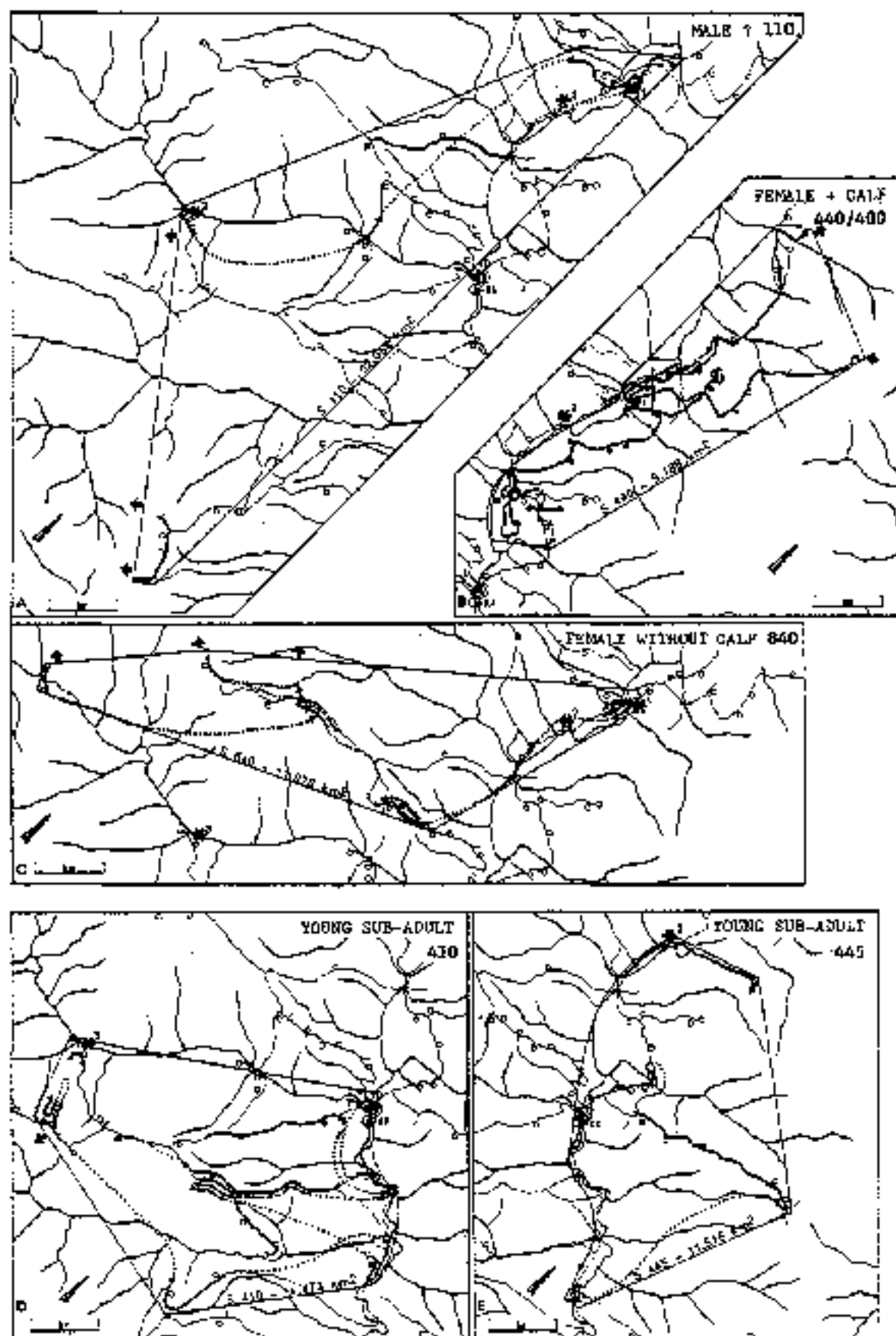

Figure 5.5

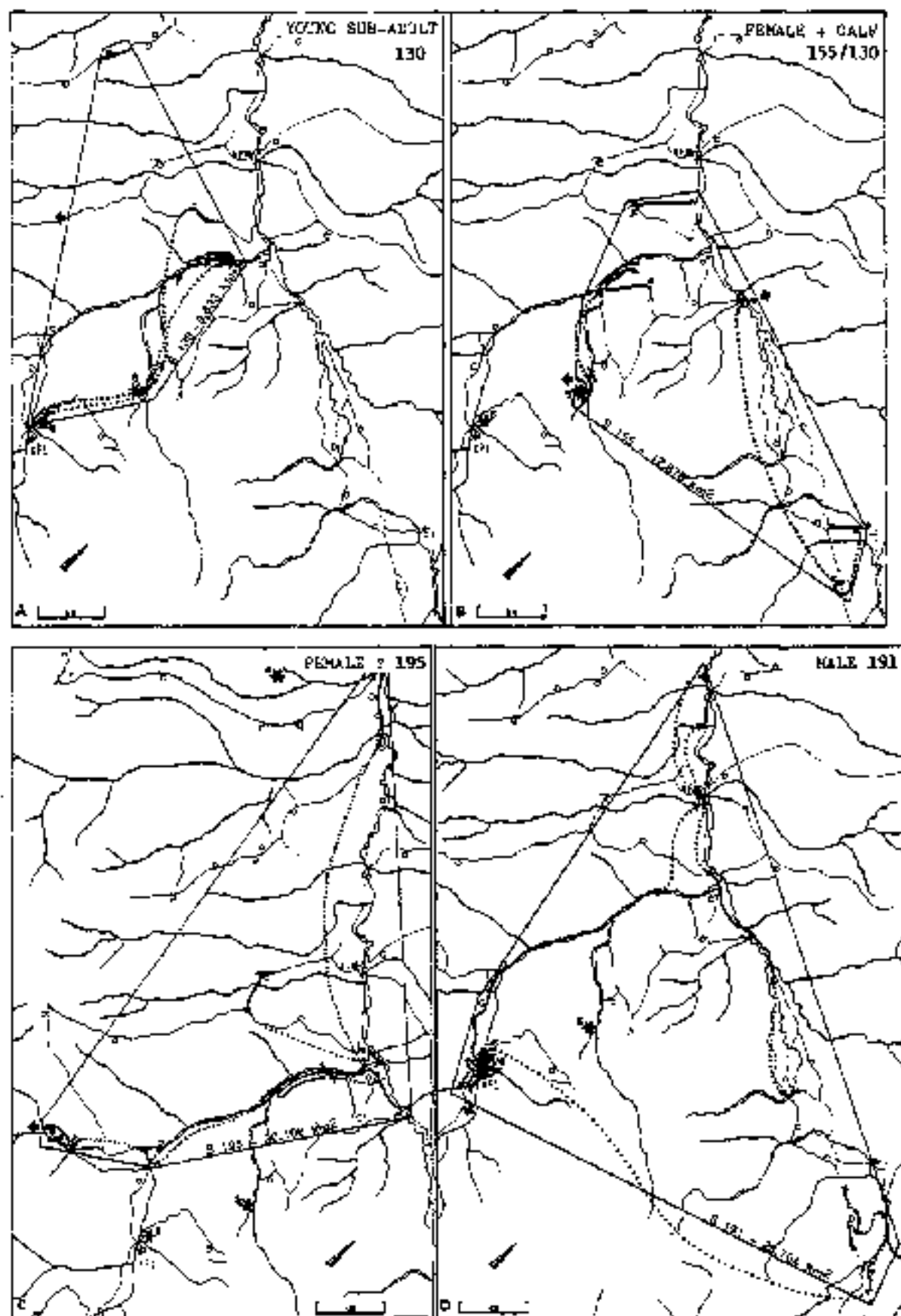

Figure 5.10

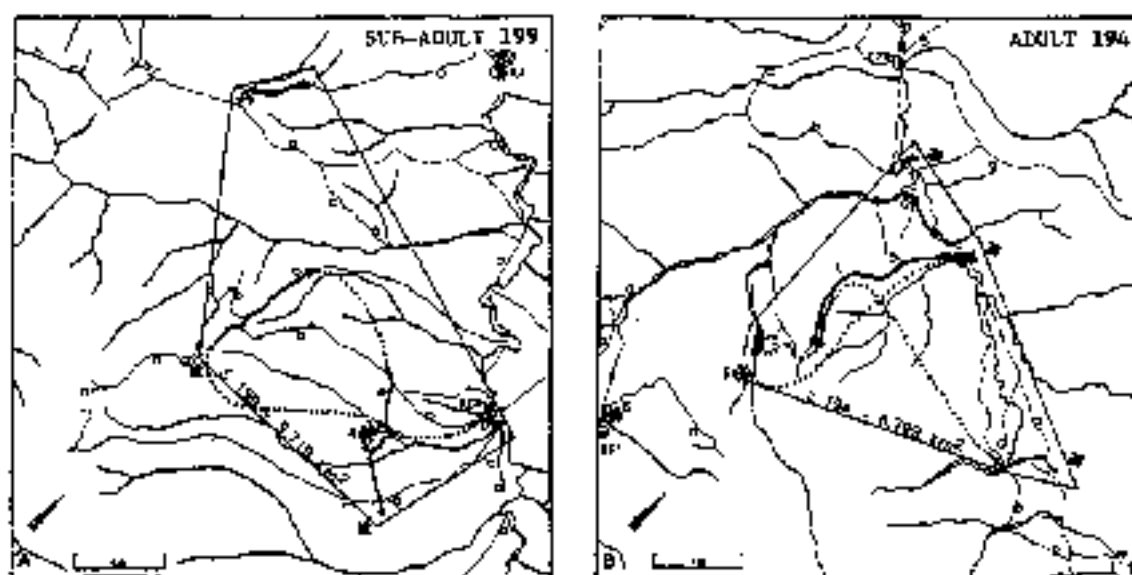

Figure 5.11

5.3 - Density of the rhino in the study area

The density of an animal population is a useful parameter for comparison with other areas and for management purposes. To study fluctuations in a population or for comparison of carrying capacities of different habitats it is sufficient to know relative densities, that is the ratio of one population to the other. For this study it was necessary to know the absolute density of the rhinos, that is the average number of rhinos per unit of area (Andrewartha, 1971), to be able to estimate the total rhino population in the Gunung Leuser reserve.

The number of rhinos in the study area could not be established by direct counts, because of the nature of the terrain. Limited visibility restricts the use of transects and direct observations as a means for calculating density (see chapter 3.3.3). Moreover the animals were shy and rarely encountered. Therefore the number of animals had to be determined from the tracks. From the distribution pattern of the inferred home ranges of all the individuals one can estimate the average number of animals present in a certain area. The number of identified individuals is the minimum number of animals present in the area. These figures can be used to calculate absolute density of the rhino in the study area.

The number of fresh tracks found in a certain area is proportional to the density of rhinos and can be used as a density index for comparing numbers of rhinos using different parts of the study area (see chapter 5.4). A fresh track count can be correlated to density and be a useful tool for censusing rhino (see chapter 10).

In the ensuing chapters a few methods are described for calculating the density of the rhino from the results of track analysis. By using the spatial distribution and extent of the home ranges of the individual rhinos a density of 13 to 14 rhinos per 100 sq km was calculated. Comparable figures were obtained from the number of identified rhinos, when the area covered by the expedition was regarded to be the area within one kilometre from the patrolled routes.

5.3.1 - Density calculations based on distribution

By mapping the ranges of individual rhinos known to be present in a given area one can estimate the number of animals likely to be present, in a certain area. This is comparable to the territory mapping techniques used to count songbirds in the breeding season (van Lavierem, 1982). The use of a technique like this for the Sumatran rhino is complicated by the absence of distinct territories, by the considerable amount of range overlap and by the largeness of the home ranges, which often fall partly outside the study area. None of the existing techniques seems applicable to this situation (van Lavierem, 1982). To make the calculations one has to

delimitate a certain test area and estimate the probability of each animal being present in this area. The probability of an animal being present in the test area is considered to be proportional to the part of its home range that falls in the test area.

Based on this principle two different approaches were tried. In the first method a rectangular test area was chosen and it was estimated which part of each home range lies in the test area. In the second method all identified records were used, and the test area consisted of the area covered by all identified records. The part of the home range that lies in this area was found by dividing the range of each animal by the estimated average home range of the age and sex class. In both methods the sum of the fractions of the home ranges lying in the test area were regarded as the average number of rhinos present in the test area.

The records from which the individual ranges were determined were collected over more than five years, but gave a reliable picture of the distribution of the animals during the study. It appears that each rhino has a definite and rather stable range, at least over the few years of the study, except for temporary shifts in the ranges of the females (see chapter 5.1.1) and gradual shifts and extensions of ranges in sub-adults (see chapter 5.1.2). Through births the number of rhinos increased, and it is possible that in the same period a few animals emigrated or died, which would have gone unnoticed. In estimates of population density only those individuals were included that were recorded during the period of regular visits to the study area, up to the 16th expedition (the 17th and 18th expedition were made in later years). In the year before the 16th expedition (see figure 3.28) 33 of the 35 rhinos found up to the 16th expedition were still occasionally present in the study area, indicating that the accumulated records are a reliable representation of the distribution of the individual rhinos around the beginning of 1979. Only two rhinos (194 and 106) may have been lost from the population since the beginning of the study.

Method I. A rectangular test area was drawn on the map of the study area, covering the best known part of the study area. The size of this test block is 93.0 sq km. The outline of the test block is shown in figure 5.12. Subsequently the presumed home range of each rhino was sketched on the map, and an estimate was made of the fraction of the home range that lies in the test block. For this estimate not only the size of the area was taken into consideration, but also the intensity of use by the rhino. When the part of the home range lying in the test block was only occasionally visited, the estimate was lowered, but when the core area lay in the test block the estimate was increased.

For example if 0.25 of the home range of a rhino is estimated to lie within the test area, the probability of the rhino being present in the test block is 0.25. The sum of the probabilities of presence for all the rhinos, is the average number of rhinos present in the test block at a certain time, from which the density per unit area can be calculated. For those individuals whose home ranges are fairly precisely known estimation was not very difficult, but for others it is at best a guess. Uncertainties about the proper boundaries of the home ranges and about the way a rhino spreads its activities over the different parts of the home range, can cause bias in this method.

The result of this calculation is shown in table II, showing total figures and figures for each sex and age class.

Method II. This method was developed to eliminate some of the bias inherent in method I, which relies heavily on one's interpretation of the size and shape of the home ranges. In this case the known ranges, not the inferred home ranges, were used, and consequently the test area is the area encompassing all the identified records. To measure the size of the individual range a polygon was drawn around the records of one rhino (see the examples in figures 5.8 to 5.11) and the test area was constructed by overlaying the polygons of all the rhinos on a map. The size of the test area is 101.9 sq km, and it is shown in figure 5.12. Subsequently for each rhino the size of the range was divided by the average size of the home range for its sex and age class (see chapter 5.2 - males 30, females 20, older sub-adults 25, young sub-adults 15 sq km). The resulting fraction was regarded as the probability of a rhino being present in the test area and the sum of the fractions is the average number of rhinos present at any given time.

For example a male with a range of 8.57 sq km would score $8.57/30 = 0.286$ for its probability of presence in the study area. In this method bias may be caused by an incorrect estimate of the average home range and differences in intensity of use of different parts of the home range. Moreover the polygons are only crude approximations of the rhino's ranges. The results of the calculations are shown in table II below.

Table II: Density of rhinos in the study area, based on the spatial distribution of the individual rhinos.
- Number of rhinos per 100 square kilometres -

	Method I	Method II	Identified Individuals (chapter 5.3.2)
Males + presumed males	3.7	3.9	
Females + presumed females	4.1	3.8	
Older sub-adults	2.8	2.1	
Young sub-adults	3.8	3.1	
TOTAL	14.4	12.9	11.3

The densities calculated by both methods do not differ substantially, either for total density or for the different age and sex classes. As a further check the total area covered by the home ranges of all individuals was estimated. Around the centres of the home ranges of the individuals, shown in figure 5.7, circles were drawn proportional in size to the average size of the home range. The rhinos with doubtful home ranges were excluded. The total area covered by these circular home ranges was 285 sq km, used by 32 rhinos, which gives a minimum density of 11.3 rhinos per 100 sq km. This figure compares well with the densities shown in table II, especially since a number of rhinos known to have part of their home ranges in this area, were not included.

The results of all these calculations depend very much on the estimates of the average home ranges for the different age and sex classes. But since detailed records are available for several rhinos, over a period of several years, these estimates must be regarded as reliable. Therefore a density of 13 to 14 rhinos per 100 square kilometres can be regarded as a fairly accurate estimate for the upper Mamas study area.

The rhino population in this part of the Gunung Leuser area is probably still at an almost natural level. In the southern part of the study area poaching had gone on for some time and several animals were killed there in the years preceding the study. In the year before the start of the study a few rhinos were killed in the area around camp Pawang. This was probably the first case of poaching in the upper Mamas area, and elsewhere in the study area the rhinos have probably never been hunted. The scarcity of rhinos around camp Pawang and the relative low numbers of rhinos in the southern part of the study area are certainly a result of poaching pressure, and we can expect that the natural population density of the rhino prior to the poaching was slightly higher.

Rhino hunting has eliminated the rhino in the fringe areas of the Gunung Leuser reserve, and this also may have reduced the numbers of rhinos in the central parts, with animals migrating to these 'open areas'. If so it was probably mostly older sub-adults, which would emigrate and may then have fallen victims. This may be one reason for the relatively low number of older sub-adults in the study area.

It is difficult to say to what extent the upper Mamas is representative of the rest of Gunung Leuser or of other areas where rhino are found or used to be found. In altitude the area is intermediate. Nowadays rhinos are rarely met at lower altitudes in Gunung Leuser, but the well-developed trail systems, now abandoned, indicate that formerly there was a sizeable population of rhinos. The same is true for some of the higher parts of Gunung Leuser. The upper Mamas could be favoured by rhinos because of the relatively shallow gradients, and because of the presence of several saltlicks; indeed it may support a higher density of rhinos than steeper areas, farther away from saltlicks. Therefore it seems appropriate to use a slightly lower estimate for other areas - 10 rhinos per 100 square kilometres - to estimate natural density of the Sumatran rhino.

5.3.2 - Density calculated from the number of individuals per expedition

The number of individuals that can be identified from tracks found during a survey can be regarded as a count of the minimum number of animals that were present in the area during the time of that survey. This method has been used to estimate the size of the rhino populations in Ujung Kulon, Java (Schenkel & Schenkel-Hulliger, 1969) and Endau-Rompin, Malaysia (Flynn & Abdullah, 1983). Differences in size of the prints and minimum distances between individuals with identical prints were used to estimate the minimum number of rhinos present in the area under study. To calculate density the size of the area that was sampled has to be measured. Schenkel and Schenkel-Hulliger (1969) assumed that their records covered the whole reserve,

while Flynn and Abdullah (1983) reckoned that their method detected all rhinos within 2 km from the patrol routes. No arguments for the choice of this distance were given.

When a track is found the animal responsible has already moved on to somewhere else in the area. By counting tracks one counts animals that are spread out at the time of the count, over a certain area around the points where the tracks are found. Since tracks remain visible for a limited time only, the animals will still be fairly close to the place where the track is counted. So one may argue, as Flynn and Abdullah (1983) have done, that the counted tracks represent the animals that are within a certain average distance of the tracks. How far that distance should be depends on the animal and on the average terrain conditions, and it is only by applying the method in an area with a known density of the animal that one can find the correct figure.

Because track count techniques are very useful for census of rhino, they have been applied to the Mamas study area, where the density of the rhino has been estimated to be 13 or 14 rhinos per 100 sq km (see above). Each expedition was regarded as a separate survey, and to count the number of animals whose tracks were found, the results of the plastercast analysis (see figure 3.28) were used, as well as a simulated track count using only the width of the print. The latter is comparable to the methods used by Schenkel and Schenkel-Hulliger (1969) and Flynn and Abdullah (1983). The area surveyed was calculated (1) as a 4 km wide transect, i.e. a 2 km wide strip on either side of the patrol route, as suggested by Flynn and Abdullah (1983), and (2) as a 2 km wide transect, i.e. a 1 km wide strip on either side of the patrol route. With the 4 km transects results showed an unrealistically low densities, compared to the known 13 to 14 rhinos per 100 sq km. For the Mamas study area a 2 km transect was more appropriate. An example of a 2 km transect, i.e. a 1 kilometre strip enclosing the whole patrol network (185.1 sq km) is shown in figure 5.12, and examples for single expeditions are shown in the figures 10.1 and 10.2.

In chapter 10 these different methods are compared to develop a useful method for censusing rhino populations. The use of print width only for identifying individuals can only be useful in populations with a very low density, where the individuals are widely scattered. For an area like the Mamas it is unsuitable as too few individuals can be identified with certainty. Using a 1 kilometre strip on either side of the patrol route and the results of the plastercast analysis, the densities calculated were fairly close to the figures known from analysis of the animal's spatial distribution. Even with a 1 kilometre strip width the average densities calculated are slightly below the density estimated from other methods and it may be that a slightly narrower strip is more appropriate, for instance 800 metres. However a 1 kilometre strip on either side is more convenient for working with, and gives density estimates that are 'on the safe side'.

Population estimates from different expeditions varied considerably, and one should allow for a rather large margin of error, when using this method to estimate the density of the rhino. The densities calculated from the results of the 'good' expeditions (see figure 10.3) varied from 5.5 to 13.3 animals per 100 sq km, with an average of 9.6 rhinos per 100 sq km. On the later expeditions (10 to 17), with more experience in tracking and casting, we calculated an average density of 11.3 rhinos per 100 sq km. The poorest results were obtained on the 5th expedition, which gave a density of 1.1 rhino per 100 sq km. For reasonably accurate results whether must be favourable, and the survey team experienced.

5.3.3 - Density calculated from the number of direct observations

Counting animals observed along a transect, is one of the more common methods of estimation of density or population size. The total of the patrols made in the study area can be regarded as one wound transect, and the number of direct observations of rhinos is the counted number of animals. To calculate the strip width of the transect the mean sighting or flushing distance at the moment of detection can be used, as in King's census method (van Lavieron, 1982).

Direct observations of rhino - i.e. the animal being seen or heard - were very rare. In total rhino were seen on only four occasions and another six times rhino were heard spotting and crashing off through the forest after being disturbed by the patrol group. The estimated distance at which the animal was first seen or heard varied from 10 to 40 metres, an average flushing distance of 30 metres. The width of the transect is 60 metres, twice the average flushing distance. Throughout the study a total of 3976.1 kilometres were walked, during which 10 direct observations of rhino were made. So ten rhinos were counted in an area of $3976.1 \times 0.06 = 238.6$ sq km, or 4.2 rhinos per 100 sq km.

This figure is substantially lower than the densities calculated by other methods above. Limited visibility in the forest allows rhinos to retreat unnoticed. The flushing distance of a rhino is certainly larger than the maximum distance at which a rhino can be spotted in the type

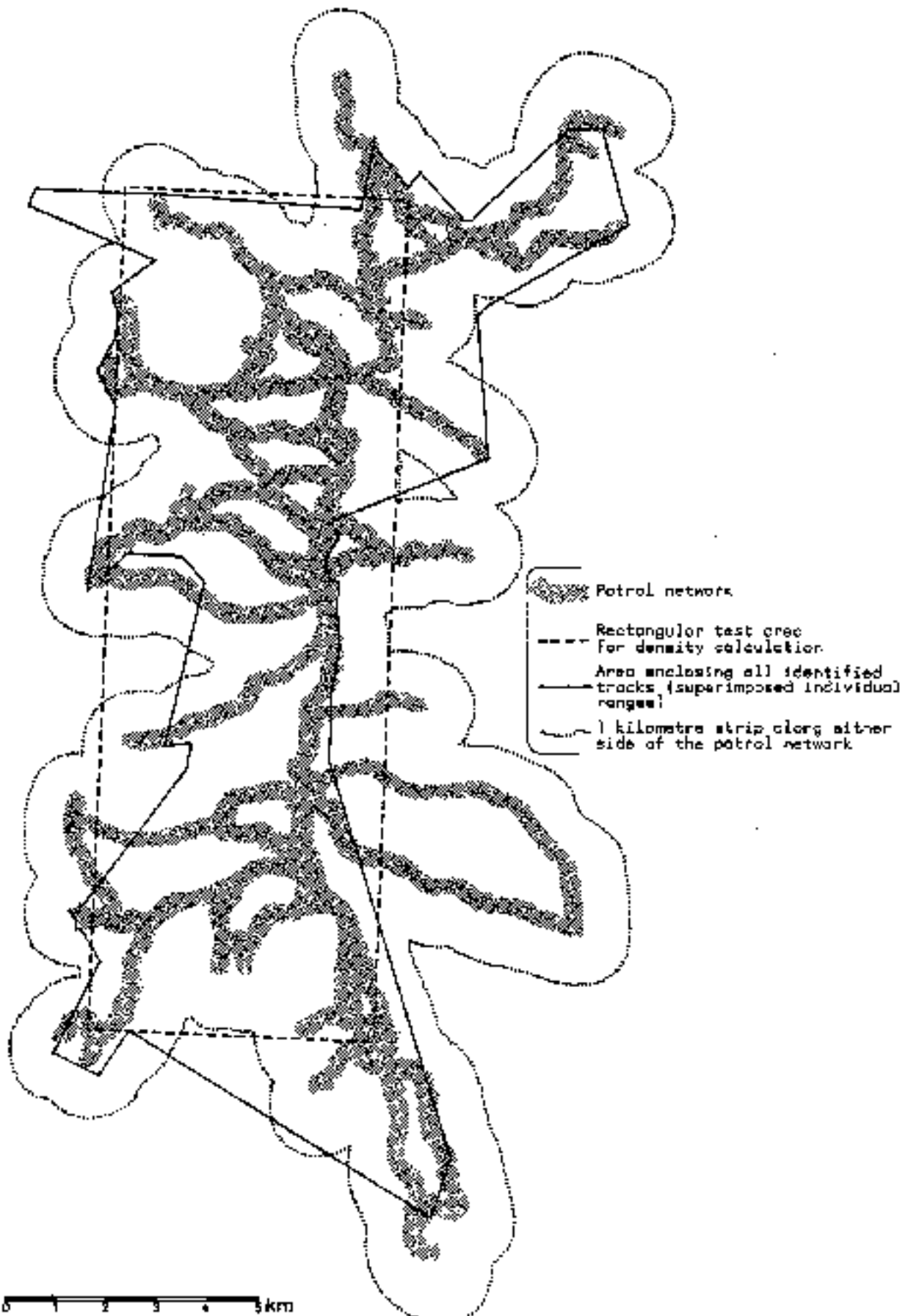

Figure 5.12 - The different delimitations used to compute the size of the test area for calculation of the density of the rhino in the study area

of forest that covers the Mamas area. Even an elephant standing motionless at about 30 metres is hard to discern. Rhinos can be heard over larger distances, but if they don't snort in alarm, they can be overlooked even at fairly close range. Several times very fresh tracks were found of a rhino that had doubled back on the trail and it is possible that the rhino had heard or smelled the patrol group and turned tail. Because of the difficult terrain patrols used only big game trails where rhinos spend only a relatively small part of their travelling time (see chapter 7.2), and it might be that they do so mainly at night. This may also explain the low number of encounters.

Relying on direct observations for studies of rhinos which have acute scent and hearing is not appropriate in a habitat where man's senses are seriously handicapped, and leads to an underestimation of the density of the population.

5.4 Comparative occurrence in parts of the area

Because the frequency of rhino visits can be calculated from the number of fresh tracks, special records were made of fresh tracks throughout the study. Fresh tracks are those made since the last rain and they are usually easily distinguishable from old tracks. By determining the number of hours between the last rains and the time of the patrol, one can calculate how many tracks were made in a certain period of time or how often a rhino visited a certain place or area. These calculations were made for all sections of the patrol network, to study frequency and patterns of use of the trails by the various rhino. The accumulated data gave some idea of how much different sections and altitudes were used, the frequency of the visits to saltlicks and the amount of use of each lick. For use of wallows see chapter 7.3.2.

During the fieldwork period a few simple experiments were tried to preserve tracks by covering parts of the trails with plastic sheets. These experiments were only partly successful, see below.

5.4.1 - Counts of fresh tracks

The age of the tracks was estimated in the field, based on the condition of the track, the soil and the prevailing weather conditions in the period immediately prior to the patrol. We also recorded whether or not the track was affected by rain. Tracks not affected by rain were called fresh, all other tracks were called old. Generally it is easy to decide whether a track is fresh or old, especially when the trail is followed for some distance. A fresh print has a smooth surface and any soil particles that have fallen into the print are still loose. Even a short shower of light rain leaves clear marks in the clay surface and causes the small soil particles to stick to the print surface, and sediment is left in the deeper parts of the print. Single prints can sometimes remain fairly fresh if they are sheltered from the rain by thick vegetation, but following the track for some meters will generally show the experienced observer whether it is fresh or not.

Since fresh tracks must have been made in the period between the last rainfall and the time of encounter it was important to keep careful daily records of the duration and intensity of any rainfall. It appeared that the rainfall was usually rather uniform over the study area, especially when it rains hard and long. A few times, mainly in periods of relatively dry weather, local showers occurred, but these can be determined from the moisture on the soil and vegetation.

For each section of the patrol network the time between the end of the last rain and the patrol time was calculated. Sometimes there had been no rain between two patrols, and the time between the patrols was taken. The dry period was summed for each section and this was called the observation time, the period when all fresh tracks must have been made. The longer the observation time the higher the probability of finding fresh tracks in that section. The longer the section the higher the probability that a rhino will have crossed the section at some place and left a fresh track.

For comparison between sections the fresh track counts were converted to the same units of time and distance. For convenience a year (= 8760 hours) and the average length of the sections (0.775 km) were chosen as units and the frequency of passing was calculated, i.e. the number of times a rhino is likely to pass through that area in a year. The complete formula is:

$$\text{Frequency of passing} = \frac{\text{Number of fresh tracks} \times 0.775 \times 8760}{\text{Length of the section(km)} \times \text{observation time(h)}}$$

The divisor of this formula is also called the km.h score, and is used in chapter 10 and figure 3.5 for comparison of the results of the different expeditions. If an animal's chance of passing through the study area is constant throughout the period of the study (and there is no reason to believe that there were seasonal or other changes in degree of use of the trails), the number of fresh tracks found on an expedition is proportional to the km.h score (the sum of the km.h scores of each section patrolled on that expedition). The km.h score can be seen as a measure for the intensity of the patrolling. The more sections were patrolled and the longer the periods of dry weather, the higher the km.h score and the higher will be the number of fresh tracks one may expect to find.

The number of fresh tracks per section was counted from the expedition maps. All fresh tracks were included, even those that could not be identified. Females with calf were counted as one, as were tracks of the same rhino recorded at more than one place on the same section. If the rhino had passed over a section on several occasions or in different directions, as for instance when it had travelled to to from a saltlick, this was counted as two. The number of fresh tracks for all expeditions together varies considerably between the sections, in many (40%) of the sections a fresh track was never found, while the highest count was 13 at one of the saltlicks. The average for the whole study is 1.65 fresh tracks per section.

There are considerable differences between the total observation times for the sections, because of the differences in intensity of the patrolling and because of the variability of the weather conditions. The sections between the camps score highest while many of the outlying sections score very low, because they were visited least and often only after rain the night before and little time was spent studying tracks along the way. The lowest observation time was 18 hours (for an outlying section of the most northern trail), and the highest value was 3187 hours, or almost 19 weeks (for a section between camp Central and camp Pawang). The average observation time for all sections was 862 hours, or almost 36 days. Because the number of fresh tracks per section is low (84% had 3 or less), despite the accumulation of the results from 17 expeditions, the results are subject to a large amount of stochastic variation. Therefore the sections with the shortest observation time have been omitted. A lower limit of 300 observation hours was chosen for each section, because then most of the isolated high values for the frequency of passing were eliminated (includes 49 of 206 sections).

1.4.2 - Frequency of use of the game trails

The frequency of passing for each section, except those with less than 300 hours observation time, is shown in figure 5.13. In a large number of sections the frequency of passing is low, especially in the middle of the study area. In these sections fresh tracks are seldom found, less than 10 or 20 times per year. But there are also sections that score much higher, where one may expect or find more than 50, or in some cases more than 100 fresh tracks, per year.

The highest values are found around the saltlicks, and there seems to be a concentration of low values along the Mamas and on the lowest sections of the trails west of the Mamas. But two to three kilometres west of the Mamas there seems to be a concentration of moderate and high values. At this place the ridges begin to rise steeply, which might explain the animal's preference for trails along the foot of the mountains. Rhinos crossing from one side of the mountain to the other seemed to prefer this route which avoids too much climbing.

The high number of fresh tracks found on the watershed between the Tenang and the Silukluk rivers may be explained by its location between two marshy areas. The rhinos seem to avoid these open places and concentrate in the narrow strip of forest between.

The average number of fresh tracks for all sections with more than 300 hours observation time is 22.3. In 55% of the cases the rhino travelled along most of the section; in the other cases it only crossed the trail or followed it for a short distance. This means that each year about 13 rhinos will pass over a section or part of it, or about one rhino per month. On the main trails leading to the saltlicks a rhino will pass about once every fortnight. About one rhino per month and one or two elephants per year is apparently enough to keep the game trails open. More frequent usage of the trails to the saltlicks keeps trails free of vegetation or litter and such trails are often deeply worn.

These figures show how effective trapping can be for hunting rhino. Traps are placed on the main trails, usually a few in succession. If the traps are properly made and triggered a rhino is not likely to escape them if he uses the trail. Occasionally traps may be triggered by other game, but a rhino poacher can expect to make a catch about every month with a set of traps placed close to a saltlick in an area like the Mamas. Over a period of just a few years poachers can kill all the rhinos using the saltlick, and exterminate the animals completely from a rather large area (see also appendix C).

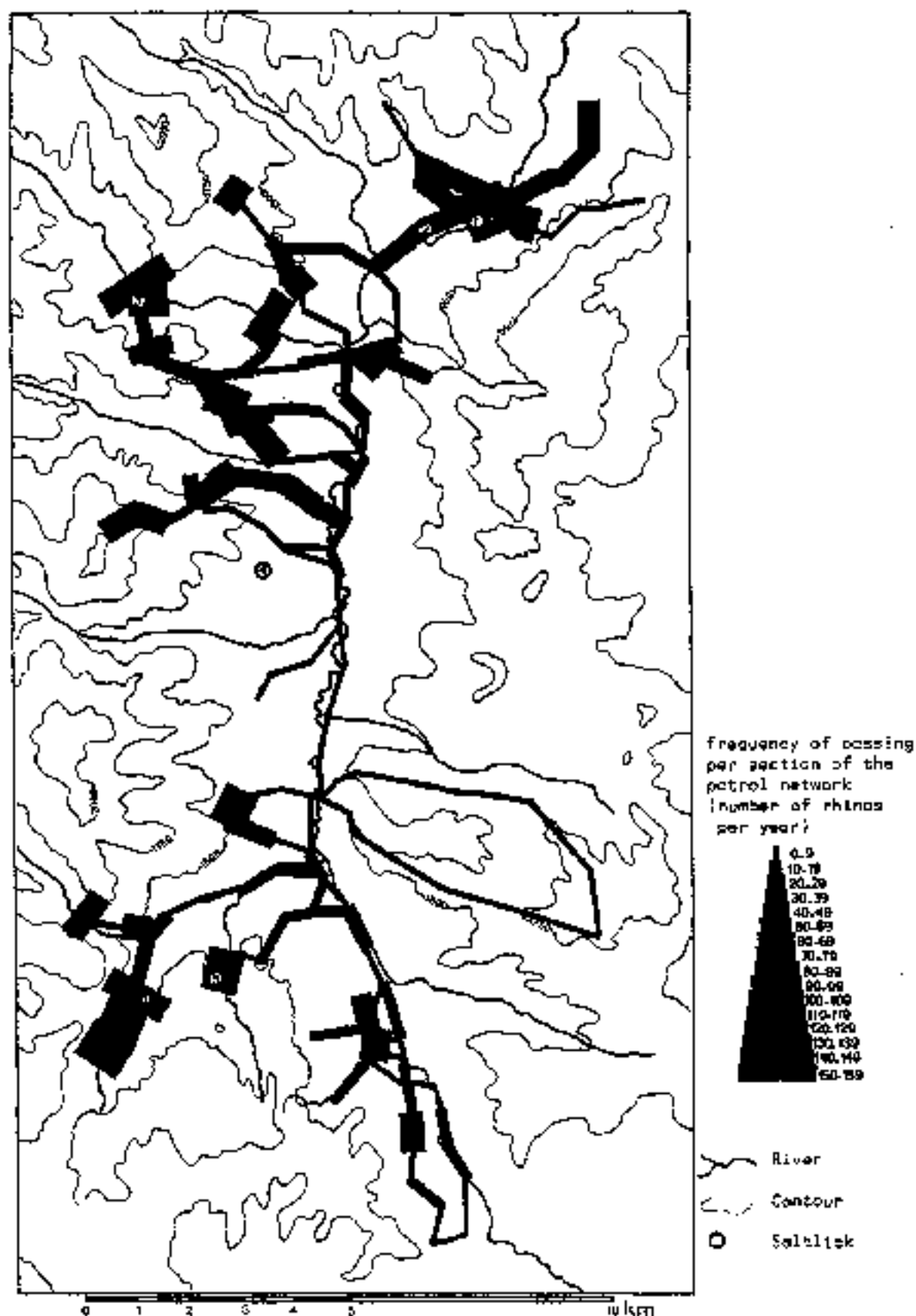

Figure 5.13 - The frequency with which the rhinos use each section of the patrol network, calculated from the fresh track counts. The broader the band the more frequently a rhino will travel that section of the patrol network. Sections that were not patrolled frequently are omitted. For the explanation of the method see chapter 5.4.1

5.4.3 - Comparison of different areas

In chapter 5.1.4 we saw that less animals used the southern half of the study area than the north. The average frequency of passing has been calculated for both parts (taking the mouth of the Sungai Niko as boundary), and shows a considerable difference. Omitting the sections with less than 300 observation hours, the average for the 73 southern sections is 17.9, while the average for the 82 northern sections is 28.0 fresh tracks per year. The lower number of rhinos in the south and the less frequent use of the game trails are probably a result of poaching in the Plus area.

Because the boundaries of the sections were chosen to follow the contours of 1200 (the lowest point in the study area), 1400, 1600, 1800 and 2000 meters altitude, it is possible to compare the rhino's use of different altitudinal zones. For zones with saltlicks the average frequency of use was calculated twice, once including and once excluding the data from sections immediately near saltlicks. The two sections above 2000 metres and most sections above 1800 metres were omitted because of short observation time. The results are shown below in table III.

Table III : Average frequency of passing per altitudinal zone. (between brackets the number of sections)

Altitudinal zone	frequency of passing excl. <300 hours observation time
1200 - 1400 m	
excl. saltlicks	14.6 (88)
incl. saltlicks	18.6 (95)
1400 - 1600 m	
excl. saltlick	28.0 (38)
incl. saltlick	33.7 (44)
1600 - 1800 m	10.8 (13)
1800 - 2000 m	15.7 (3)
TOTAL	
excl. saltlicks	17.9 (142)
incl. saltlicks	22.3 (155)

There are differences in rhino use between the zones, especially between the two lower zones. With or without the saltlick data the average frequencies of passing are markedly higher in the second zone, which could be seen as an indication that rhinos prefer the zone between 1400 and 1600 metres. The next zone, 1600-1800 metres, seems to be less favoured, but the number of sections in this zone is low; if we exclude the entrance route sections from this category (there are very few resident rhinos in this part of the study area), the average frequency of passing is 17.9 (8 sections).

Since the Mamas river is an important boundary for most of the rhinos (see chapter 5.1.4), the lowest section (1200 - 1400 m) was divided into three parts: - the sections along the Mamas, the sections on the ridges, and the Tenang - Silukluk area (excluding saltlicks). The Tenang - Silukluk area showed a similar amount of use (15.5 rhinos per year) to the whole southern half. The sections along the Mamas averaged 10.2, a relatively low value, but the sections on the ridges had an average of 20.0, much higher than the river-sections.

Therefore the difference between the two lower altitudinal zones is due not so much to preference for altitude, but the rhinos choosing to use the trails along the Mamas river less frequently than the trails over the ridges. They could be deliberately avoiding the river, but this seems unlikely. Rhinos generally walk for only a short distance along the river before going back up the slopes (see chapter 5.1.4). So are generally only recorded in one or two sections at the river, but on the ridges rhinos often follow the big trails for a long distance and are then logged in several sections in succession. The low frequencies of passing scored on the sections along the Mamas river is probably not due to rhinos avoiding this area, but the fact that they wander away soon from the main trails here.

Rhinos show less preference for altitude than would appear from the figures in table III, but still the values for the 1400 - 1600 metre zone are the highest of all. It appears that the rhino has a slight preference for this zone, at least compared to the higher zones. The game trails are certainly best developed in this zone. Lower on the ridges trails are often narrower and less open and at higher altitudes they are often fragmented. The juicy undergrowth, the rhino's favourite food, appears more prolific at the mid-altitudes in the Mamas area.

5.5 - Other methods to record the use of the trails

Two other methods were used to count the number of rhinos that pass over the game trails. Thin plastic sheets were placed over the soil, to prevent rain washing away the tracks. At a place where the trail was well-developed, preferably with some obstacles left and right, the loose top layer of soil was removed and the soil was loosened. Then a piece of plastic sheet - about 75 cm wide and 1 metre long - was laid over the prepared ground, fastened with twigs, and camouflaged with some litter.

On the next visit the plastic was lifted and plastic and soil were inspected for impressions of rhino hoofs. The tips of the hoofs pierced or stretched the plastic and left faint impressions of the hoofs in the soil surface. Because the stride of a rhino is about 75 cm, each passing rhino can be expected to leave at least one impression on the plastic. But it is difficult to see whether two impressions close to each other are made by different rhino or by the fore- and hindfoot of the same rhino. The impressions are often very vague, especially when the soil has dried out, and it is difficult to see how many animals have passed especially if there are several impressions on the plastic.

Plastic sheets can be laid quickly and they are not easily displaced by passing animals, but results are difficult to interpret. During the study plastic sheets were laid at 28 places in 17 locations throughout the study area. In total 119 rhino tracks were counted during the 12 388 days that the plastics were functioning, or about 3.5 rhinos per year.

A second method involved the construction of a plastic roof over a short section of trail, to shield it from rain. This requires much more plastic, but the results are better. It was hoped that identifiable tracks could be obtained, but that was never the case. A piece of thick plastic, about 2 m wide and 3 m long was suspended over a suitable section of trail and supported by oblique poles tied to nearby trees. The roof was placed three metres or more above the trail and the soil beneath was cleaned and loosened. It was rather difficult to find suitable places, where the soil was neither too dry nor too wet, and that would not be flooded during heavy rain. Sometimes the roof collapsed because of decay in the poles, but most were destroyed by passing elephants. Even when placed about 4½ metres above the ground the roofs were invariably torn down and the plastic trampled and torn by elephants. Rhinos seemed undisturbed by the roofs; their tracks showed that animals did not hesitate nor avoid the roof.

Plastic roofs were pitched at 16 different locations, but only a few functioned well for a long period. Many of the selected locations flooded during heavy rains, and few tracks remained visible till the next inspection. It is easy to count the number of tracks under the roof, and the results obtained from some of the better-situated roofs are probably fairly accurate.

A total of 58 rhino tracks were recorded under the roofs, which remained in situ for 4920 days. This means that on average 4.3 rhinos passed any given location in a year. The four best sites, roofs over a large trail over a ziggè, gave results of 6.6 rhinos per year, or about one animal every two months.

From counts of fresh tracks (see chapter 5.4.2) an average frequency of passing of 13 rhinos per year was calculated, double the highest value found with the methods described above. But these plastic sheets cover only a very small part of the trail, while the fresh track counts covered whole sections of several hundreds of metres, including places like wallows and saltlicks, that are especially attractive for rhino. This and the deficiencies of the methods as described above must be responsible for the different results.

5.5 - Frequency of visits to the saltlicks

The saltlicks play an important role in the life of a Sumatran rhino, as will be clear from the previous descriptions of distribution and range. How frequently rhinos visit the different saltlicks was calculated from fresh track counts in relation to the observation time (see chapter 5.4.1). Of 39 rhinos in the study area 10 were never found at a saltlick. Three of these (105, 148, 810) probably use an unknown saltlick outside the study area and will not be considered further here. The other seven probably frequent one of the known saltlicks, and are treated with the rhinos known to visit the licks. For each saltlick the time interval between rhino visits was calculated by dividing the observation time (the number of hours between the time of the inspection of the lick and the last rain, for the duration of the study), with the number of fresh sets found at the lick. The results are shown in table IV below.

Table IV: Frequency of visits of any rhino to the saltlicks.

Saltlick	nos. of rhino using the lick (observed+suspected)	no. of times fresh tracks found	observ. time (in hours)	interval (days between visits)	frequency (visits to lick per year)
1	5+1=6	8	1576	8.2	44.5
2	4+2=6	5	1700	14.2	25.8
3	6+0=6	6	811	5.6	64.8
4	2+3=5	1 (discovered on 17th expedition)			
5	5+1=6	2	564	11.8	31.1
6	7+0=7	7	1565	9.3	39.2
Average for all saltlicks				<u>9.3</u>	<u>39.5</u>

Use of saltlicks by rhinos varied little between licks, but saltlick 3 seemed to be the most popular, while lick 2 was least favoured. The results at saltlick 2 are certainly biased by the fact that it lies in the centre of several warm springs and potential licks. Several times fresh tracks were found bypassing saltlick 2 en route to some other lick close by, and these tracks were not included in the count. In fact the whole complex of licks and springs was visited more frequently than lick 2 alone. On average one rhino visits a saltlick every 9 days or so, an interval that compares well with the frequency with which animals were recorded travelling the trails close to the saltlicks (where one may find a rhino about once per fortnight - see chapter 5.4.2), considering that there are several trails going to each saltlick.

Visits to saltlicks by each sex and age class were analysed separately, and females were considered for both the period with and without calves. For each individual the observation time (during which it might have visited its usual saltlick) was calculated and a count made of the number of times its fresh tracks were actually found. Observation periods and numbers of fresh tracks were totalled and for each age and sex category the average interval in days between rhino visits was calculated. The results are shown below in table V.

Table V: the frequency of visits to a saltlick of an individual rhino.

	female - calf	non-breeding female	sub-adult	male
No. of rhinos	8	8	11	10
No. of fresh tracks	6	7	6	9
Total observation time (hours)	3292	7462	8531	11943
Interval in days	22.8	43.8	59.2	55.3
Frequency per year	16.0	8.3	6.2	6.6

The interval between male's visits to the saltlicks may be too high, because there are a number of animals presumed male that are only rare visitors to the study area. The average interval for the four males that were regularly encountered is much lower, 26.2 days, similar to the figure calculated for a female with calf. The two best known resident males (520 and 610) visit saltlick 3 more frequently. On three occasions fresh tracks of male 520 were found at the lick, with an interval of 11.3 days between visits. Fresh tracks of male 610 were also found, and both males together used the saltlick with an average interval of 13.3 days.

It appears that resident males regularly visit the saltlicks, and females with calf make more visits to the licks than do other rhinos. A breeding female visits the saltlick once every three weeks or so, while a non-breeding female goes there on average only once every six weeks. Sub-adults use the saltlick even less frequently, only about once every two months or so.

CHAPTER 6 - THE LIFE CYCLE

Very little is known about the life cycle of the Sumatran rhinoceros, and even the more recent field studies have added little to our knowledge on mating, reproduction, growth, development etc. Prior to this study there were no basic data on gestation period, period of nursing, age of first breeding, longevity, breeding interval etc. But there was consensus on the fact that the Sumatran rhino is a slow breeder, with single calves being born at intervals of several years (van Strien, 1974).

One of the more remarkable details in all the older reports of the Sumatran rhino is that evidence of calves was seldom found. Also during the more recent surveys of Borner in Sumatra and Flynn in Malaysia the tracks of young calves were rarely met. Borner (1979) estimated that 4 - 5 calves were present in the Sungai Pinus - Sungai Kompas area during his three-year study, but he gives no details on date and place. In all the other areas that he visited, covering most of the known rhino areas of Sumatra, only in the Kerinci-Seblat area in central Sumatra did he find tracks of a calf. In a six year field study in the Eddau-Rompin area only three cow and calf pairs were recorded (Flynn & Abdullah, 1983).

During the present study many tracks of cows with calf were found, but it cannot be said that they were common. Finding a track of a young calf was still an exceptional and happy event. It was probably only because of our methods of intensively patrolling a large area including several saltlicks, that so much evidence of calves could be gathered. Often extra patrols were made in areas where a calf had been found before.

In this chapter various population parameters relating to breeding and reproductive success will be discussed.

6.1 - The sex ratio of the population

Of all the rhinos that have been captured, dead or alive, and have been reported in the literature, the great majority were females (van Strien, 1974; Borner, 1978), but it was generally believed that this apparent imbalance of the sex ratio was caused by selectivity of the capture methods. Borner tries to explain this by assuming that males have exclusive territories around willows, saltlicks and focal points of the main trails, where traps are usually built, so that at such sites only one male is likely to be captured, but several females.

This view is not supported by the results of this study. The territories of males are large and overlap considerably, and more than one male may use the same saltlick and trails, although the core areas of their distribution are probably well separated. Males range over larger areas, and probably make even more frequent visits to saltlicks than do females. The explanation of the fact that males are apparently more difficult to catch is probably a combination of distribution and character. The rhino traps are usually operated for a long period on regularly used trails in a rather restricted area. Males range over large areas and spend probably less time in any one place, while females appear to limit their activities, in and outside the breeding period, to relatively restricted ranges. Females regularly use the same trails, which is certainly the case when going to a saltlick (see chapter 5.1.4), while males might be more alert and wary, used as they are to explore unfamiliar ground. Of the 10 times a rhino was seen or heard during the study, 7 were of animals later identified as females, 1 was a juvenile and only 2 were males; on both occasions male 520. This could indicate that males are more alert and more difficult to approach.

The sex ratio among the adult animals identified in the study area seems to be fairly even. Of the 21 adults, 8 were known to be females, and 4 were classed as males. Of the rest 2 were thought to be females (see chapter 5.1.1) and 4 males, because of their distribution and ranging patterns (see chapter 5.2.4). This gives a ratio of 10 females to 8 males, while another three adults, occasional visitors to the study area, were also suspected of being male.

The adult sex ratio of populations of the Indian rhino and of the African rhino species is about even or with a slightly higher number of females (Laurie, 1978). The males of these species are usually territorial and fierce fighting between rival males is common, which may account for the lower number of males in some populations.

6.2 - The mating system

Most reports in literature so far indicate a short-lived bond between male and female, but several older authors have stated that Sumatran rhinos live in more or less permanent pairs (van Strien, 1974). Borner (1979) assumes exclusive territories for dominant males, and Kurt (1970) voices the opinion that females have rather small permanent territories, while males wander

around in search of females in oestrus. Both opinions are mainly intuitive and not based on substantial evidence.

This study has been able to add little to the understanding of the meeting and mating habits of male and female Sumatran rhinos. But everything points to a short-lived bond between male and female, because tracks of two animals moving together, other than cow and calf, were extremely rare. Several times tracks of different individuals were found along a trail or at a saltlick, but in most cases it was clear that they had visited separately; one of the tracks was clearly older, or came from a different direction. On some occasions it is possible that some rhinos visited the lick together or met there.

Only once during this study were tracks found that showed undoubtedly that the animals had walked together. The animals were later identified as male 610 and sub-adult 460, one of the larger and less frequently encountered sub-adults. Both had descended the ridge from the west at the junction of the Mamas and the Sungai Markus. After a short circuit they returned in the same direction. Later tracks of this pair were found at saltlick 3. The tracks were of about the same age, but it was not clear whether the animals had visited together or not. Also at the top of the jalan Sudirman two rather similar tracks, that could not be identified with certainty because of their bad quality, were found crossing the trail. Here again it was not certain whether the animals were there together or separately a short while apart. So it could be that the animals were travelling together, or that one followed the other closely, from the saltlick to the Mamas, a distance of about 5 kilometres. This meeting certainly did not lead to a successful pregnancy, because rhino 460 was found again on the 15th and 17th expeditions, about 500 and 800 days later, without a calf.

In the previous chapters it has already been explained that males have much larger ranges than females, and that they have a tendency to make quick excursions over rather long distances. Non-nursing females on the other hand seem to have rather restricted ranges on the higher slopes. With a calf females remain close to the saltlicks in the lower parts.

There also appears to be a difference between males and females of behaviour at the saltlicks. Males wander all over the area surrounding the lick and often leave such a confusion of tracks that it was sometimes very difficult to determine where the animal had come from or gone to. But when females visit a saltlick their tracks are generally easy to follow. They often make a few short tours around the saltlick, but their trails are direct and usually clear; they seem to visit the lick and then leave its immediate surroundings.

Males apparently hang around the saltlick, presumably investigating the neighbourhood, while females only make a quick visit to the lick and leave again, consistently returning by the same trail. A male explores the area around the lick, possibly to find a scent trail of a potential mate that has been there shortly before. There are indications (see chapter 5.6) that some males make more frequent visits to saltlicks than others. For instance male 520 visited a lick on average once in 11 days.

The importance of the saltlicks as a contact place, is further illustrated by the visits that males sometimes make to saltlicks other than the ones they regularly use. Males 610 and 520 regularly use saltlick 3, but were both found very close to saltlick 2, and male 520 probably actually went there, but there in the confusion of tracks it was impossible to be completely sure. Twice male 520 was also found close to saltlick 4, and it could be that he occasionally inspects this lick. Visiting more saltlicks will certainly increase the chances of picking up the track of a potential mate and increase chances of encounter with other rhinos.

6.3 - Birth of the young

From the size and shape of the footprint of very young rhinos the approximate date of birth can be extrapolated, as has been shown in chapter 4.1. The smaller the prints and the more often a calf was found the more accurate this extrapolation will be. For all calves the growth curves were compared visually with figure 4.1 to determine the approximate time interval during which birth occurred. The results are shown in figure 6.1. The scale runs from August till July, because no births were thought to have occurred during these months.

The number of births varied considerably from year to year. In 1975 and 1980 apparently no calves were born, while probably 6 of the 12 calves that were found were born in 1976. In the following three years, 1977 to 1979, each year a few births occurred, most of them in the second half of 1978 and in 1979. From the data collected during this study it seems that most births occur from October till May. The period with little or no births, June till September, coincides with the long dry season (see figure 2.4), and it seems that most calves are born in the periods of heaviest rainfall.

The gestation period of the Sumatran rhino is unknown (van Strien, 1974). One would expect it to be shorter than for the other rhinoceros species, because of the animal's smaller body-size. The other rhinoceroses have gestation periods of around 16 months, and are about twice the weight of a Sumatran rhino. There is one unreliable report of a gestation period of

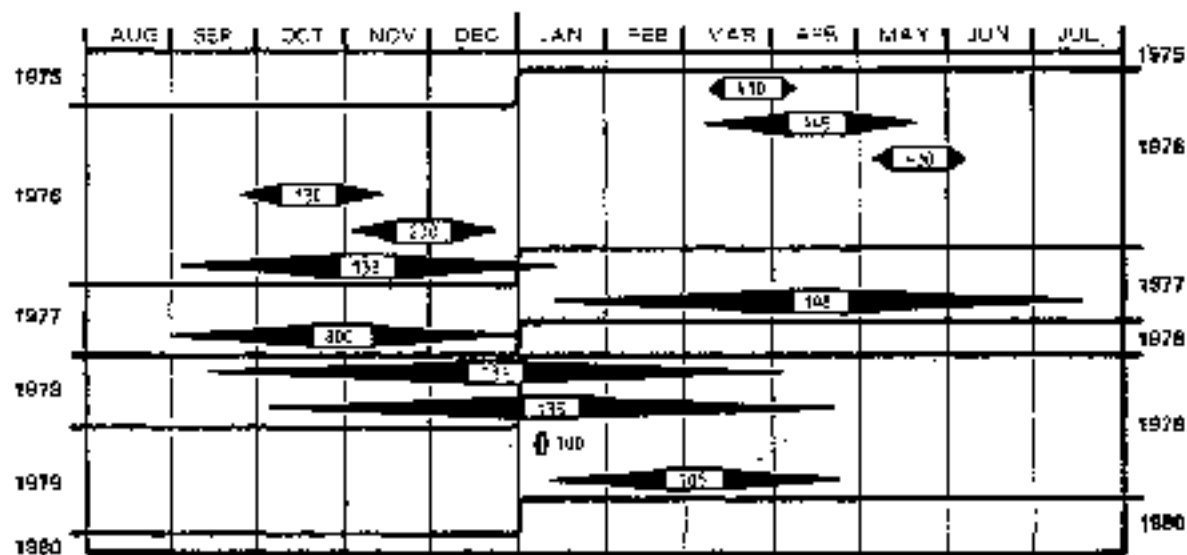

Figure 5.1 - The approximate time intervals during which calves were born in the study area. Each bar indicates the time interval during which the calf was presumed born, based on the growth curves of the foot and on the occurrence of the tracks of calf with cow

around 7 months for a Sumatran rhino (Bartlett, 1973), but usually the gestation period is estimated to be between 12 and 16 months.

In this study we could gather no information regarding the gestation period. No female was found together with another adult rhino prior to giving birth. There are only two records of females about one year prior to giving birth, but both were walking singly and none of the males was nearby.

6.4 - The breeding interval

The duration of the study was too short to record two successive calves known to have the same mother. Therefore there are no precise records regarding the interval between two successive births, but a minimal interval can be measured from the periods that females were recorded without a calf.

Female 700 was found wandering alone over a period of about 1055 days before giving birth to calf 100. Female 840 was found for the first time 500 to 600 days before giving birth, and female 440, after having separated from her calf, was found regularly over a period of at least 500 days. In all cases the intervals between individual records were so short that no calf could have been born and raised during that period. Adding the nursing period of 480 to 540 days to these figures gives a minimum period between births of 1000 to 1600 days, or 2.7 to 4.4 years. Female 444 was found again 1550 to 1600 days after giving birth, but unfortunately was not recorded in the intervening period. In theory she could have had another calf in this period. Female 700 was found more often and certainly did not have a calf in the three years before calf 100 was born, moreover it is unlikely that this was her first calf, because this rhino has a large foot with strong profile, suggestive of fairly old age. If this is not an exceptional case, the normal breeding interval will be four years or longer.

In chapter 5.1.1 kinship has been suggested between the calves 105 and 410 and between calf 135 and an unknown young (146?) found on the first expedition. If this is true the breeding intervals are respectively about 1050 and 1500 days, about 3 to 4 years or more. All evidence points to the breeding interval being considerably longer than the 2 to 2½ years that cover gestation (8 to 14 months) and the ensuing nursing period (16 to 18 months). In the Mamas study area a female Sumatran rhino normally only breeds again a considerable time after she has separated from her calf. It may be that this long interval between births is caused by poor quality of the available food, and that a female rhino needs a long period to recover and to build up enough strength for nursing another calf.

In this respect the Sumatran rhino differs considerably from the Indian rhino (*Rhinoceros unicornis*), where the calves remain with their mother for three to four years, and only leave her shortly before the birth of the next calf. The breeding interval for that species in Chitawan, Nepal, is comparatively short, on average 34 months or 2.8 years (Laurie, 1978).

6.5 - Development of the calf

The new-born calf is about 60 cm high, 90 cm long and weighs around 25 kilograms, and it is for the first few days probably hidden by the mother in vegetation while she browses (Bartlett, 1873). On one occasion tracks of a very young animal were found, estimated to be not more than 15 days of age (see chapter 4.1). This infant (calf 100 from female 700) was found very close to saltlick 1 and may have been born there. The other calves found during the study were two months or more when they were found for the first time.

In the first months of life the calf remains very close to the cow. The small prints of the calf are then often obscured by the cow's prints, walking behind the calf. Several times it was only after a track had been followed for some distance that it was discovered that there was also a small calf accompanying the cow. Many times the calf was found to have walked in front of the cow for a long distance, but sometimes the cow led.

On one occasion we met cow 440 and calf 400, then about 3 months of age, in the forest. After the first alarm the rhinos walked away. After some moments of silence the cow came running back and passed us closely. The calf did not follow and while running the cow sprayed copiously with urine and defecated several times. When alarmed young calves apparently take cover, while the cow tries to divert the attention. To avoid further disturbances no search was made for the hidden calf.

Older calves wander away from the cow, and both tracks form intertwining lines, alternating diverging for several meters and coming together again. After some time the calf is found to walk alone and the cow is generally no longer present in the area where it nursed the calf (see chapter 5.1.1). But it might be that there is still a loose bond between cow and calf, because three times after separation tracks of a cow and her calf were found together in the same place. From the age of the tracks it seems that they were not there together, but it could be that one was following the other's trail and that they occasionally still meet.

As has been explained in chapter 4.1 and shown in figure 4.1, the cow and calf separate after about 500 days (480 - 540 days). At the time of separation the foot of the calf is still markedly smaller than the adult foot, and it is reasonable to suppose that the animal's overall size and bulk will also be less than the adult's. Comparing the growth curves shown in figure 4.1 and the foot dimension for the age and sex classes as shown in figure 4.5, it was found that the median values of the calf's footprint at separation were about 85 percent of the median values for the adults.

If the same percentage can be applied to the other body dimensions, the height of the animal at separation would be about 85% of the adult's shoulder height (125 - 135 cm) or about 105 to 115 cm. The weight would be $.85^3 \times$ adult weight (800 - 1000 kg) or 500 to 600 kg. Growth must be close to one kilogram per day during the period of nursing, if the calf is to grow to more than 500 kg in about 500 days.

6.6 - The sub-adult phase

After separation growth levels off. In the first year or so of independence there is still noticeable growth of the foot, but later the growth is hardly visible and much less measurable. A few calves were found for about two years after becoming independent, and their footprints were still clearly those of a young animal, smallish and without distinctive features. Several other rhinos found with similar footprints were called sub-adults. They were presumed born prior to the start of the study. Some of these were found for four or five years, and in that period they appeared to have grown only very little. Looking at the whole series of casts sometimes a slight increase in size appears to be visible, but in the standard measurements there is no detectable increase. The individual variation between the casts is many times more than the supposed increase in size.

Different sub-adults showed appreciable differences in size, some were very similar to the calves shortly after separation, others were larger and in size and character were similar to the tracks of the adults. This indicates that the sub-adult period is probably longer than the longest period - 5 years over which they sub-adults could be followed in this study. It could well be that the sub-adult phase lasts for 6 or 7 years or even longer. Probably the Sumatran rhino does not reach sexual maturity and age of first breeding until 7 or 8 years old at least.

The sub-adults form a fairly elusive group. Not only are their prints difficult to identify, but most were found over long intervals of several expeditions, and scattered over a large area. The small sub-adults - the calves in the first few years after separation - have small and clear-cut ranges, but the larger sub-adults appear to range over large areas. In their first two or three years of independent life a Sumatran rhino lives in a relatively restricted area, usually close to a saltlick and in the lower part of the valley. Later they become more and more exploratory and range over vast areas, probably trying to find themselves a vacant range between the established adult ranges.

At the end of 1962/early 1963 a sub-adult rhino visited the Ketambe Research Station a few times (A plastercast was made by Dr. H.D. Rijksen). This station is at least 20 kilometres from any of the existing rhino areas and the only previous record of a rhino there dates from 1971. Occasionally rhinos are also reported from other places, far from the known centres of rhino distribution. It might be that these wandering individuals are mainly sub-adults, like the one in Ketambe, forced to explore new territory to establish a home range when the main rhino areas are already 'full'.

CHAPTER 7 - DAILY ACTIVITIES OF THE RHINO

In the following chapters we will look at the daily activities of the rhino. Many of these aspects of the rhino's life have been described in detail by previous field surveys (Borneo, 1979; Flynn, 1978; see also van Strien, 1974). A major shortcoming of the use of indirect evidence of animal movements for the analysis of the daily activities is the difficulty in estimating the age of the tracks or other signs. It is usually possible to tell if tracks and other signs are very fresh, no more than a few hours old, from the freshness of mudsmears, scratches on bark, trampled plants etc. But these very fresh tracks were rare and usually it is difficult to be more precise in dating than to say for instance 'last night', 'previous day' or '2 to 3 days ago'.

With older tracks it is even more difficult to make an estimate of their age. Under the moist conditions of the tropical forest, drying and discolouring of mud, faeces, scratches and bruises on plants, can be very slow. Mudsmears known to be several days old were found to be still wet and appeared freshly made. The wounds on broken and snapped twigs can remain moist and light-coloured for days or even weeks, so that they appear to be freshly damaged. Moreover there are great local differences; a track can appear very fresh in one place, and several days old only a few meters further on.

On the few occasions when a rhino was met, it was usually a complete surprise. Although we were following fresh tracks, there was nothing to indicate that the rhino had passed only minutes before. In one case it was even judged from the discolouring of the faeces that the track was probably two days old, yet we met the rhino only a few hundred metres further on. In other cases we followed what seemed to be very fresh tracks very cautiously in the hopes of seeing a rhino, but after some time it became obvious that the track was at least many hours or even days old.

7.1 - The system of trails

One of the characteristic aspects of a rhino area, at least in the mountains, is the existence of an extensive network of wide, clear and well-used game trails. The trails generally follow the rivers and the ridges, forming a huge network for easy travel, and used not only by the rhino, but also by other forest animals and man. Very little clearing is needed to follow a rhino trail and on the bigger trails one can easily walk 15 to 20 kilometres in a day. When a trail has to be cut in difficult terrain like the upper Mamas, one can not expect to travel more than 5 kilometres per day and often less. It was only because of the existence of the rhino trails that such a large area could be surveyed in the time available. See figure 2.5 for the location of the trails that formed the patrol network.

Trails are generally better developed in the larger valleys and on the main ridges. The trails along the major rivers like the Mamas and some parts of its tributaries are well developed and cross the river frequently to cut off bends in the river. Where the trail crosses the river the banks are generally eroded by heavy use. At a few places along the Mamas the trail crosses a low spur, here the trail has worn away a narrow trench, to 4 metres deep at the centre. These deep cuts are caused by heavy animal traffic. On steep slopes rain washes out the trails, but nowhere is soil erosion serious.

The trails along the bigger rivers often branch, with side trails going to alternative crossing places or vanishing into the vegetation. At the foot of a main ridge there are sometimes well defined side trails leading up to the ridge. The trails along the smaller streams are much less developed. As long as the streambed is flat the animals follow the stream, but cutting off the largest bends. Where the streambed is steeper the trail leaves the stream, but occasionally minor trails cross the rivulet.

Where the banks of the Mamas are steep the trails go up the slopes, generally following a spur between the river and a small side stream, to reach more level ground, after which the trail continues more or less parallel to the river. North of camp Acen the trails leave the river for a few kilometres, because the Mamas enters a narrow steep-sided valley. Where the valley broadens again the trails descend again to the river until camp Uning. Just north of this camp the Mamas enters a deep gorge and the trails rise again and follow the edges of the gorge.

The trails on the ridges are even better defined than those along the river, probably because of the drier and harder soil and the less vigorous undergrowth. On every spur and ridge there is a trail, but those on the main ridges of the watersheds are the best developed. These trails are between 40 and 100 cm wide and are generally worn with use. On the trail the soil is bare with a little moss. The vegetation alongside the trail is meagre, and most of the saplings and trees are bent, broken or otherwise damaged by animals passing.

As one would expect the trails follow the easiest route, avoiding unnecessary gradients. They circle small peaks on the ridges and on steep gradients, more than about 15°, they zigzag

or climb gradually along the side of the ridge, to avoid the steeper parts. There are usually few side trails along the ridges, only where two ridges join. In some of the passes trails cross the ridge, but these are little used and often barely visible. Large trails join the main ridges two to three kilometres west of the Mamas, on the gentler slopes below the steep ridges. These parts of the trail system are used frequently by the rhinos (see chapter 5.4.2).

The best developed trails are found at middle altitudes, between 1400 and 1800 metres, but the trails converge on the highest mountain tops in the study area. In the low stunted forest or shrub of the higher slopes the trails form narrow tunnels, deeply worn in the thick layer of moss and organic detritus that covers the soil. At some places trails are especially well developed, mainly around the saltlicks, where they converge from all sides.

Although many forest animals make use of the trails, it appears that it is mainly rhinos and elephants that are responsible for shaping the trails. Elephants generally follow only certain routes, along the main rivers and some of the ridges, but rarely venture away from their traditional routes. The trails along the Marau and those over the Tanang and Siluktuk watershed and entering the study area are mainly made and maintained by elephants. But the rest of the trails over the ridges are chiefly made and used by the rhino.

It is not only the weight and foot movement of the passing rhino that shape the trail, but also their habit of scratching the soil and bending and breaking of saplings which keeps the trails free of vegetation. Smaller animals also help to keep the trails open and clear. Sambar, barking deer and tiger make use of the trails and occasionally scratch the soil there, wild boar and hog badgers grub along the trails and pheasants were often found scratching on the trails. Although smaller animals help to maintain the trails, they appear to have very little influence in the development of a trail system, because in areas where the rhino and the elephant are absent there are no game trails, except occasional low tunnels through the thicker.

In areas where the rhino has been exterminated by man trails disappear gradually. On the ridges behind the Ketambe Research Station the trails are still visible, although rhino have not used the area for at least 10 to 15 years. The trails were deeply worn, indicating that former traffic must once have been heavy, but now the trails are overgrown and with young trees (their trunks thick as an arm) growing in the middle.

The fact that trails disappear once the rhino is gone may have an influence on other animals, limiting their mobility. Tracks of tiger and wild dog often followed the trails for long distances and seem to do most of their travelling over the game trails. Deer, pig and bear also use the trails regularly. Although none of these animals are absent in areas where there are no game trails, the greater mobility offered by a network of game trails might have a positive influence on their chances for survival, certainly for the large carnivores.

7.2 - The daily movements

Anyone who spends some time in a rhino area will get the impression that the Sumatran rhino is an inexhaustible walker, constantly on the move along trails and through the forest. One can follow a track for hours without seeing much signs of other activity than walking. With remarkable ease rhinos push through thick, tangled and often thorny vegetation, and unless the animal is heading for a saltlick, their movements appear rather haphazard and purposeless. Faeces and urine are found along the rhino's track; the animal will have made use of one of the wallows it encounters or it has laid down somewhere. It will have made a mark here and there by scratching the soil or breaking saplings, but traces of feeding will generally be rare. Occasionally the rhino will have eaten a few leaves along the trail, but to find evidence of more systematic feeding, one often has to follow a track for several kilometres.

The main trails are frequently used by the rhino, but often only for a relatively short distance. In chapter 5.4.2 we noted that only 95% of the tracks followed the trail for a whole section (average length 775 metres) or more. Elsewhere the track followed the trail for less than half a kilometre, often for only a few metres. In some cases tracks crossed the trail at right angles. In some cases the rhino followed a trail from the river to the top of the mountain and beyond, but it often wandered off the trail and followed a parallel route through the forest for a few hundred metres.

In the field it appeared that on the main trails most of the animal's movements were uphill. The number of uphill and downhill movements on the main ridges were counted. A total of 43 uphill tracks were counted against 22 downhill tracks, confirming the initial impression from the field. It appears that when climbing rhinos prefer to use the easier ridge trails.

When a rhino is walking off the trails, it usually more or less follows the contours of the slope, moving gradually up or down, crossing small streams and the minor ridges. On a bigger ridge the animal usually follows the trail for a short distance. When a rhino starts feeding it often travels in wide circles, frequently returning to or crossing its own trail. Following such a trail is almost impossible. In other instances the rhino wanders from side to side while feeding.

In their daily movements the rhinos are probably mainly guided by the topography, with the rivers and the ridge trails being important landmarks. Marks made along the trails may help in orientation, as signs that the rhino is on familiar ground (see chapter 7.4). It appears that rhinos can smell wallows from some distance, because many times rhino tracks suddenly changed direction and headed straight to a wallow in thick vegetation some 50 to 100 metres away. After a bath animals often returned to the previous trail, giving the impression that they have a good sense of direction. Several times tracks deviated from a trail that was blocked by a fallen tree several metres ahead, suggested that the rhino had spotted the obstacle from some distance. This suggests that the rhino's eyesight is not as poor as previously believed (van Strien, 1974). In thick tropical vegetation the rhino's eyesight is probably as adequate as ours is.

The rhino does not particularly like to follow rivers and streams, but will follow a flat streambed for a little way. Generally rhinos leave the streambed soon, apparently preferring to travel along the slopes. Open marshy areas, covered with long grass and sedges, as on the Sungai Tenang - Sungai Silukluk watershed, are clearly avoided. Occasionally rhino tracks were found crossing these marshes, but the main trails carefully circled the swampy open area.

It will be clear from the individual distribution maps presented in figures 5.8 to 5.11, that there is no fixed pattern of movements with animals all following regular routes. Apart from the traditional routes to saltlicks rhinos seem to wander through their range at will, but normally do not leave a specific area, their home range. Animals seem to use topography as an important means of orientation.

The Mamas river, and to a lesser extent the main tributaries, serve as boundaries of the individual ranges (see chapter 5.1.4). Almost without exception a rhino, upon reaching the Mamas river, returned in the direction it had come from. This habit, and the animal's tendency to following the contours and use the main ridges in upward direction, means that the rhino will almost automatically be guided back towards the centre of its range. This pattern of movements is also the most energy efficient. Climbing is unavoidable in a mountain area and costs much energy, but by following the contours along the slopes or following the gradual ridges, the rhino avoids the steepest slopes, thus saves energy.

During this study there was usually no time available to follow single tracks for longer than necessary to make some casts, and when a track was followed it was generally impossible to make reliable estimates of the time and duration of the different activities of the rhino. It is therefore impossible to give estimates of average daily ranges, duration and rhythm of activities like feeding, wallowing, resting etc. Only in a few special cases, for instance when the animal was met, could the time and duration of certain activities be estimated.

Once a rhino was met twice on one single track. This happened on the 7th expedition, when at dusk (15 October 1976; 18.30 h) a rhino with a calf were seen swimming in the Mamas in front of camp Uning. The next morning the track was followed until we met the two animals again at the northern periphery of the study area and a day later the track was followed in the opposite direction. The tracks were later identified as female 440 with calf 400, then about 5 months of age and about half the height of its mother. Their route is shown in figure 5.9B.

The trail started at about 1600 metres, 3.5 km northeast of saltlick 1, where the rhinos had been feeding on the young growth on a landslide. Apparently they had fed there before, because there were also older tracks. From this feeding place they followed a well-marked trail to the saltlick. They passed two wallows, took a bath in a small wallow and descended on a zigzag course to the saltlick, mostly following good trails, except for the last 700 metres. Between the feeding area and the saltlick the animals defaecated twice, the faeces of cow and calf a few metres apart.

Upon reaching the Mamas they swam 50 metres downstream, and climbed up the rocky bank in front of the camp. Before the animals came into view, swimming side by side in the fast flowing river, loud squeaking and snorting sounds were heard. After clambering onto the flat rocks that border the river, the rhinos walked side by side for another 5 metres along the bank, before disappearing into the forest. They did not show any sign of alarm at our presence.

The rhinos probably used only a few hours to cover this distance, including the mudbath, and they probably spent the morning feeding and resting and departed after noon for the saltlick. From the river they passed the saltlick and headed for the main trail to the north. They passed several of the springs making up saltlick 1, but it was not possible to see whether they had drunk some saline water, or simply walked through.

From the saltlick they followed the main trail for almost 4 kilometres till it crossed a side river of the Mamas. They kept to the trail, except where it crossed a stream, when they followed the streambed. But they always returned to the trail.

About 1 kilometre from the saltlick the rhinos took another bath in a wallow along the trail. There were no traces of feeding along the trail and faeces were dropped in a small stream. Along this part of their route were six soil scrapes, apparently made by the female. Where the trail crossed one of the bigger streams, almost 4 km from the saltlick, the rhinos left the trail and followed the stream for about 250 metres. The stream is 4 to 5 metres wide in a rather flat bed. Soon after leaving this stream they started to feed on the undergrowth. At a few places the rhinos had lain down.

At 13.45 h an alarm snort and rustling of vegetation was heard ahead. Moments later the cow was seen running in the direction of the stream. The cow's track was followed for a short distance, until it became clear that the infant was not following, and the survey team left the animals to avoid further disturbance. The cow walked fast, with long strides, and there was a very strong smell of urine all along the trail, and here and there some fresh faeces.

It is not likely that the rhinos took more than a few hours to cover the four kilometres from the saltlick to the feeding site, even including the wallow. Humans need about 4 hours to walk the same route, and a rhino at ease will probably travel little faster. It was estimated that the pair arrived at the feeding site before midnight, and remained there for the rest of the night and the whole morning, feeding and resting, until they were disturbed by the patrol team.

Very fresh tracks of the same pair were followed on the 9th expedition (12 April, 1977) when the calf was about one year of age. In the early morning a fresh track was found about 300 metres north of saltlick 1, travelling south. These tracks were very freshly made since a patrol the previous afternoon and the same tracks were also met the same morning 3 kilometres further south. The tracks must have been made during the night.

This time the tracks did not lead to the saltlick, but south, parallel to the Mamas, more or less following the contours. The pair walked in a zigzag fashion through the forest, only occasionally following minor trails. About 3 km south of camp Ucing they descended to the Mamas and immediately returned up the same slope again. Here the tracks were found in the early morning. The animals proceeded south, occasionally following trails until they came to the steep slopes along one of the side rivers of the Mamas and they turned back to the north and the patrol trail. The trail was lost, but tracks of the same pair were seen at several places crossing the patrol trail. They obviously had made more rounds in the area.

Probably the track the patrol followed was made during one night, and possibly a few hours of the next morning. A few times the rhinos had eaten a few leaves from a sapling or bush and in three places fresh faeces were found. No scratches were seen but there was one record of urine sprayed on the vegetation. This route, taking 20 hours or less, included seven baths in a wallow, and the rhinos used all wallows they passed.

On the 7th expedition, another rhino was met south of camp Pinus. This rhino was later identified as being female 196, who shortly afterwards gave birth to calf 200. In the afternoon very fresh tracks were found at saltlick 6, coming from the direction of Medan Badak and leaving the lick, to travel south, parallel to the river. The tracks were estimated to have been made not earlier than the previous evening. The track continued south for about 1.5 kilometres. Then the rhino crossed the Sungai Pinus, and started to feed on the undergrowth, crisscrossing the area, and recrossing the narrow stream many times. The rhino also wallowed in a muddy place in the stream.

After feeding the rhino retraced its steps for a short distance and started to climb a rather steep slope zigzagging through the forest. Upon reaching the ridge it followed a trail south for about 150 metres. Then the animal left the trail to travel west. There, at 10.30 h, we met up with the rhino, who dashed off in alarm unseen. This place was about 1 kilometre from the feeding site.

Along the track fresh faeces were found four times and the rhino made two soil scrapes. Away from the feeding site the rhino had taken a few plants along the route. The rhino passed a few wallows, but only took a bath in the stream. The track that was followed was probably made in about one day, or slightly longer. Since the distance covered was relatively short, the rhino cannot have spent much time in walking and must have spent most of the time, at least for a whole night, plodding around at the feeding site, leaving there early in the morning.

On the 16th expedition (3 June 1979) a very fresh track of juvenile 148 was found in the early morning, close to camp Central. It must have been made that night, because the track was not there the previous afternoon. At 9.30 h this rhino was met at 1700 metres by part of the team, about 4 km further west. The rhino came from the summit west of camp Central and followed the large trail over the northern ridge down to the Mamas river. There it walked around a bit and briefly crossed the river. Then it retraced its steps, following the trail to the summit and proceeded south. On both sides of the river the rhino browsed on the undergrowth and took a bath in a muddy spot. One soil scrape was made near a wallow close to the river and along the route five times sets of fresh faeces were found.

The rhino walked more than 12 km in probably less than 20 hours, and probably half of this distance at night. It fed only sporadically along the Mamas and probably stayed only a short time near the river. It seems that the rhino descended to the Mamas during the night, browsed for a while, then started back very early in the morning. It could be that the whole trip lasted less than 12 hours.

Other tracks were followed for some time during this study, but no reliable estimates could be made of the time the rhino engaged in various activities. As described above, the animal's activity consisted of alternating periods of intensive feeding in a small area and periods of

steady walking. Intensive feeding appears to last for several hours and the animals occasionally lay down during feeding, probably to rest. They also may take a mudbath in a wallow or suitable place in the feeding area. In the few cases described above intensive feeding occurred late at night and in the morning, and such behaviour may be the normal pattern.

While travelling rhinos appeared to walk steadily, stopping only for an occasional bath in one of the wallows along the route. Sometimes a few bites were taken from a plant along the trail, but often the rhino did not eat anything for several kilometres. Occasionally a soil scratch, or other mark, was made along the route and the rhino defaecated once about every 1 to 3 km. When a rhino started to walk after a period of intensive feeding it usually continued for several kilometres and up to 12 km were covered in less than a day. Walking occurred both by day and night and the rhinos apparently had no problem in following the trails in almost total darkness. A mudbath was taken at least once per day, but usually more often. Sometimes all wallows encountered were used, and the rhino took seven baths in the course of one night. In other cases the rhino walked for several kilometres, passing a number of wallows, before a bath was taken.

7.3 - Wallows and wallowing

7.3.1 - Location and form of the wallows

The mudbath plays an important role in the daily life of the Sumatran rhino. Several times a day rhinos take a bath in a muddy place, often at a special wallow, and cover the body with a layer of mud, which keeps the skin moist and probably also protects the animals against biting insects. The mud seems vital for keeping the skin and the animal healthy. If an animal in captivity is denied the use of good bathing facilities its skin becomes cracked and inflamed, and the animal soon dies (van Strien, 1974).

Mud pools or wallows that are regularly used by rhino have a specific form and are a prominent feature of rhino areas. Other animals also use the wallows, such as wild boar, deer and occasionally elephants, but the rhino is the most frequent bather and his activities determine the size and shape of the wallows. It is easy to see from the size of the pool and from scratches on the banks whether the wallow is used by rhinos or not.

Rhinos bathe both in special wallows, and at other muddy places they happen upon during their travels. Occasionally they wallow in muddy patches by the river, in a small stream, in a saltlick or even in a peaty marsh on the mountain top. In flat areas, along the Mamas and in the Sungai Tenang-Situkluk area, there are very few typical wallows, because there are many other places where a rhino can take a mudbath, but on the mountain slopes, where wet places are few, the rhinos use the same spot repeatedly, thus creating a typical rhino wallow.

Wallows are made in places where the drainage is poor and the soil remains wet for some time, often found on flat areas on the mountain tops, in saddles or on little plateaux on the slopes. Sometimes a pool formed behind a fallen tree trunk or in the cavity left by an uprooted tree is used. The visiting rhinos deepen these wallows by rolling in the mud, digging until an oblong pit, some 2 to 3 metres long is formed. When the wallow is freshly used it is filled with a slimy soft mud, but after a while the soil particles settle and the water becomes clear.

Many wallows dry out after some days without rain, but some retain water for several weeks. During the study it was never so dry that there were no places to wallow on the ridges, and it is not likely that the availability of places to wallow influences rhino distribution in the study area. Even after three weeks without rain, an exceptional event in the Mamas, several of the wallows along the ridges still contained sufficient water for rhinos to bathe.

In many places only one wallow is made, but sometimes several pits are dug out, though only a few seem to be in current use. The others are overgrown or filled with leaves. Large wallow complexes are common along the main trails. In one place the complex included 30 different pits. Trails lead to the pits and most of the vegetation around the wallows is trampled and smeared with mud.

The rhino digs soil from banks next to the pit with its horn and feet, probably to thicken the mud in the wallow, and thus forms a vertical wall besides the wallow. Vertical grooves cut by the horn are often found on the wall. Repeated use causes the wallow to become deeper and deeper dug into the slope and the vertical wall becomes higher and higher. Sometimes the wallow burrows under soil and roots. In several cases the wallow had been dug in a few metres, forming a wall one or two metres high. In one wallow the digging had proceeded about 15 metres, encircling a big tree on the slope, and forming a wall of some three metres high. Such wallows must have been in use for many years.

There are a large number of wallows in the Mamas, with 170 different locations recorded, but there are many more. Whenever a rhino was followed outside the patrol network, new wallows were encountered along the route. Along the patrol trails 115 wallows and wallow complexes were found (one per 1.4 kilometres) and these are shown on the distribution maps in fig-

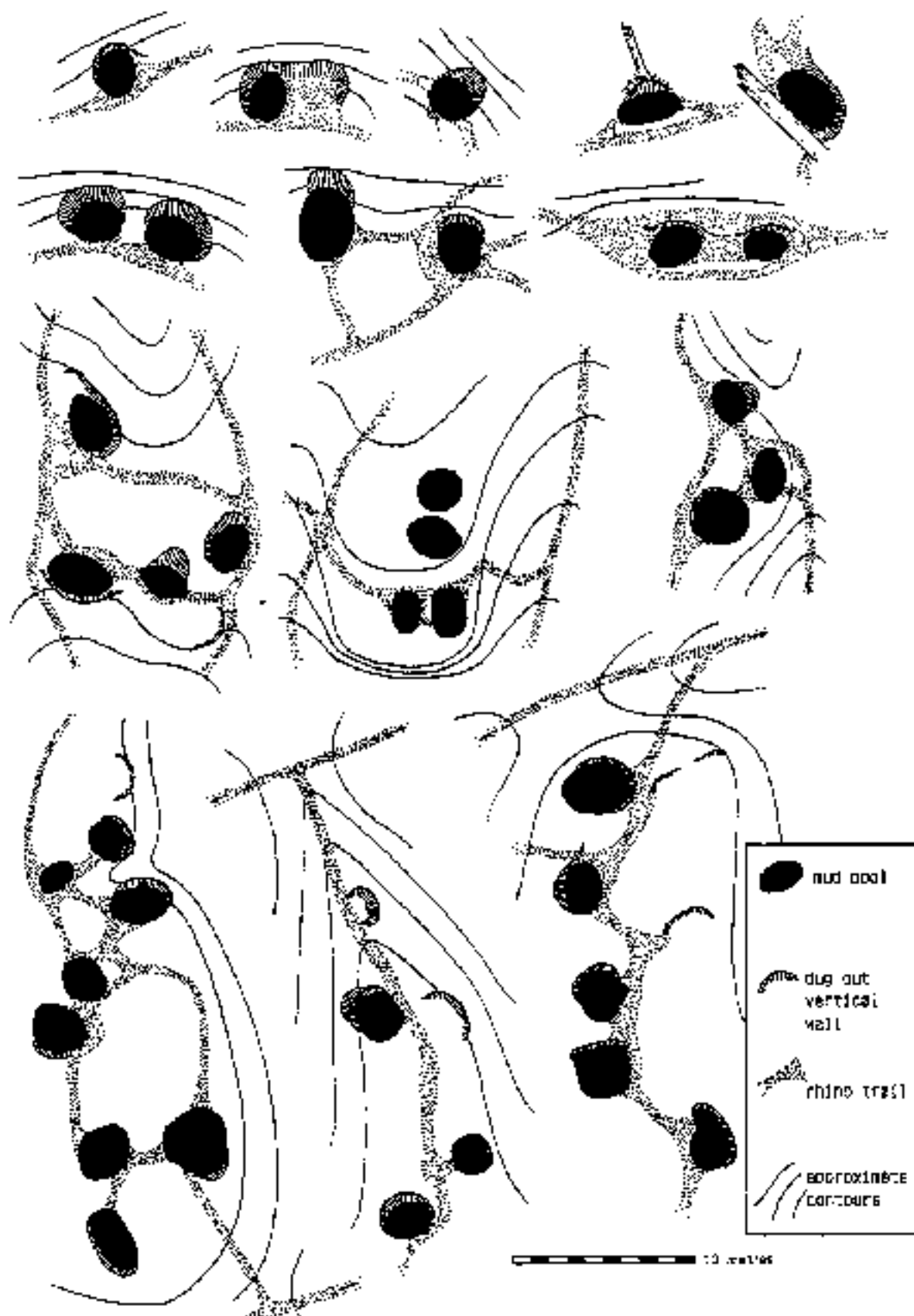

Figure 2.1 - Sketches of walloes and wallow complexes found in the study area. All drawings are on the same scale

wres 5.8 to 5.11. In time changes take place as new pits are made and others abandoned or covered with fallen wood. Sometimes pits which have not been used for many years are reopened.

During the first few expeditions all wallows encountered (89) were measured and a sketch map made of the location. A selection of the sketches is drawn to scale in figure 7.1. The wallows are on average 2.75×2.10 m.

7.3.2 - Pattern of use of the wallows

Wallowing is an important part of the daily routine of the Sumatran rhino, but how often a bath is taken varies greatly. In a period of 24 hours or less one animal (see chapter 7.2) used all 7 wallows along its path. In another case the rhino wallowed only once in about the same period. Also sometimes a rhino was found to use almost all wallows on its route, in other cases animals walked for several kilometres, passing a number of wallows, without taking a bath. Once a rhino used two wallows a mere 50 metres apart.

A reliable figure for the number of times that a rhino wallows per day cannot be given, but all evidence indicates that animals bathe at least once per day and usually more frequently. We did not notice more frequent use in dry periods, as was reported by Burner (1979). It is impossible to study the relation between weather and use of wallows from the available data, but in periods of very heavy rains, when the soil is muddy and the vegetation remains wet for days, the rhinos still used wallows, and in periods of prolonged draught, when the number of wallows that still contain water is reduced, rhinos sometimes walked past some of the few remaining wallows.

Wallows are used both by day and night, as is evident from the four tracks described in chapter 7.2. It is difficult to estimate the duration of an average mudbath, but from the condition of the mud in a freshly used wallow and the amount of mud splashed around, the rhino normally spends some time in the wallow, perhaps several hours. Three of the ten animals met during the study were disturbed at a wallow.

The number of fresh rhino tracks were counted at 106 wallows and wallow complexes along the patrol network. The sum of the time intervals between the last rains and the moment of inspection (see chapter 5.4) was calculated for each wallow. From 106 wallows 36 fresh tracks of rhinos that had used the wallow were recorded in 81910 hours of observation time, an average frequency of use once every 94.8 days or a little less than four times per year.

If each wallow is used only four times a year, and each rhino takes at least one bath per day, there must be a large number of wallows - one hundred or more - within each rhino's home range. There must be many more wallows in the area than those found along the survey trails. Whenever a track was followed off the main trails it soon led to a wallow, and rhinos appear to be able to smell wallows from some distance (see chapter 7.2).

During the first two years of the study an attempt was made to record the use of wallows. Yarn was stretched a few centimetres above the water of the wallow. A broken or dislodged thread shows that the wallow had been used since the yarn was fixed. 42 wallows were fitted with yarn, but the experiment was discontinued because it told no more than other signs around the wallow. Although it is easy to see whether a wallow had been used since the previous visit, it was seldom clear how many times it had been used. On each expedition the yarn was renewed. The accumulated time between placing the yarn and inspecting was 8085 days during which 65 rhino visits were made, once every 124.4 days.

Wallows are not used exclusively by one rhino, but several rhinos may use the same pits. Ten wallows were known to have been used by at least two rhinos and two wallows by three different rhinos. Probably a wallow can be used by any rhino that happens to pass nearby.

7.4 - Marks and marking behaviour

Another feature worth noting in a rhino area are the marks made by rhinos along the trails; soil scrapes, broken and twisted saplings and faeces or urine. Such marks, generally only found along the trails, may be visual and olfactory signals, intentionally left by the passing rhino. Burner (1979) made a careful study of these phenomena and little can be added to his descriptions. From field records of the marks made by the identified rhinos in this study, it is possible to determine how often such marks are made by the different sex and age classes and this might indicate their function.

The most common mark is a scratch in the soil, made by a single movement of the hind-foot, which leaves a bare patch of soil some 50 cm wide and 70 cm long and several cm deep, and they are usually made at an oblique angle on the side of the trail. It seemed in this study

that the hindfeet are always used for scraping, but Borner (1979), who made more detailed observations reported 10 per cent of the scrapes made by the forefeet. Other animals (tiger, deer, barking deer) also make scrapes along the trails, but these are generally much smaller. Scrapes made by sambar deer can sometimes be mistaken for rhino's as they may be similar in size and sometimes associated with broken saplings.

Scrapes often occur with other signs. One or two saplings close to the scrape may be bent or broken and sometimes even twisted around, while the bark and the twigs and leaves are usually severely bruised by the rhino's teeth or horn or by rubbing. Faeces are sometimes deposited on the scrape and kicked backwards into the vegetation, and urine is sprayed over the vegetation or splashed on the soil. Occasionally rhinos deliberately twist saplings, breaking the top and twisting it one or more times around the lower part of the trunk.

Tree bending and twisting, kicking of faeces and spraying of urine are also found away from scrapes. Such sign may be made singly or in combination. Rhinos do not seem to leave marks at regular intervals. Sometimes no marks are made for several kilometres, but elsewhere scrapes may occur every hundred metres or less and rhinos break or twist almost all the saplings along the trail. Generally however a travelling rhino leaves only a few marks as it walks along a trail and these are usually single scrapes.

The smell of the faeces and urine is only noticeable for a short time in the wet tropical climate, but the scrapes and the broken and twisted saplings are visible for a longer period, especially at higher altitudes. Borner (1979) discusses similarities in the marking behaviour of the Sumatran rhino and the other rhino species, and concludes such behaviour is a means of indirect communication, leaving signals for other rhinos that visit the same locality and helping a resident to recognize his whereabouts. Twisting of saplings is seen by Borner as a form of marking behaviour usually performed by dominant bulls. Flynn (1978) assumes that these rhino marks are territorial markers, mainly aimed at keeping other rhinos away, a spacing mechanism to reduce exploitation of a limited food resource.

Few scrapes or other marks could be assigned with certainty to a particular rhino and only when the track was very fresh and the soil conditions such that the track could be followed step by step. On fresh trails the number and sort of marks made by an individual rhino were recorded. The length of the tracks was measured on the distribution maps. In table VI below the total number of marks of all types, the total length of the tracks and the number of marks per kilometre of track are given for the different age and sex classes.

Table VI: Frequency of marking

	length of tracks	number of marks	marks per kilometre track
young sub-adults	40.5 km	2	0.05
older sub-adults	19.2 km	21	1.09
females	53.9 km	22	0.41
males	35.5 km	16	0.45
other adults	17.8 km	5	0.28
Total	166.9 km	66	0.40

On average a rhino makes a mark every 2.5 km or so. Adults, both male and female, follow this pattern, but the young sub-adults (animals in the first 2 or 3 years of independent life) rarely make marks while older sub-adults seem to mark more frequently than the rest of the population.

Although fresh tracks of juveniles were frequently followed these animals rarely left marks. Even for juvenile #10, fresh tracks of whom were found almost every expedition for 1½ years after separation, only one broken sapling was recorded, when the rhino was about three years of age. On another occasion this animal may have left a scrape sprayed with urine. The only other mark left by a young sub-adult was a single soil scrape made by rhino 146 close to a willow (see chapter 7.2).

In contrast to the very young rhinos the older sub-adults show a high frequency of marking, more than double the value found for the adults. Of the 6 older sub-adults the 4 better known animals were found to have made marks; two sub-adults known from a few short tracks north of camp Uning failed to score. The most frequently encountered sub-adult, rhino 140, showed up on 10 expeditions and 5 times left one or more marks; 4 scrapes, 3 scrapes with faeces, and one scrape with broken saplings and sprayed urine. For the other three sub-adults a total of 11 more scrapes, one broken sapling and once scattered faeces were recorded.

Five of the eight adult females made marks, mostly scrapes (16), while 4 were scrapes with faeces and 2 scrapes with sprayed urine. Bent or broken saplings were never found in asso-

ciation with a female track. Most of the marks were found in the periods that the females were without young, some were recorded for females accompanied by young. Female 440 left scrapes and scrapes with faeces or sprayed urine (see chapter 7.2).

On average males did not make more marks than females, but the frequency of marking seems to differ greatly between individual males. Most of the marks recorded for the males were made by male 610, who scored 1.8 marks per kilometre. This animal had one of the largest footprints, and is probably large in body size. This male ranges over a large area and is the only male ever found together with another rhino. Male 520, with a somewhat smaller foot, lives in a smaller range, which overlaps extensively the range of male 610. Although male 520 was the most frequently recorded rhino, it made only three marks. Most marks (12) recorded for the males were scrapes, with 2 scrapes with faeces or urine and 2 scrapes with broken saplings.

All age and sex classes marked trails with soil scrapes, either single or in combination with faeces and urine or bent or broken saplings, and such behaviour is certainly not the exclusive behaviour of males or dominant males. Although only 16 marks were recorded for males, it appears that combination markings, such as scrapes with faeces or urine and broken or twisted saplings are the speciality of males. The difference in marking behaviour of males 610 and 520, both living in roughly the same area, may mean that bigger males make more marks. Such marking may be a sign of dominance. It may be that marks are made mainly at the core of the home range and not over the whole male range, because some other males, who are less frequently present in the study area, seldom made marks. Females probably mark more often in their non-breeding ranges than when accompanied by a calf, and breaking and twisting saplings is not female behaviour.

In the first few years of life, when the rhino lives in a rather restricted area, close to where it was born, the youngster seldom makes marks, but later, as older sub-adult they range over larger areas and more often leave marks. It could be that this frequent marking is associated with the establishment of a permanent home range. Several of the older sub-adults broke saplings, which could mean that they are young males, as has already been suggested in chapter 5.2.3.

The scarcity of marks made by very young rhinos and the larger number made by young animals nearing adulthood and the bigger males, suggests that the marks are not only a means of orientation, but that they also serve a territorial function. It may be that rhinos indeed have a tendency to avoid areas where fresh marks indicate the presence of other rhinos, which would, as Flynn (1978) suggested keep the animals evenly spaced. In the Mamas study area the males and the females were indeed rather evenly spread (see chapter 5.1.4). There might be separate spacing mechanisms for males and females, because there appear to be differences in marking behaviour, with broken and twisted sapling left only by males.

7.5 - Faeces and defaecation

The faeces of the Sumatran rhino are very characteristic, and even old faeces of many weeks or months are easily recognizable. Each dung heap consists of 10 or more roundish or ovoid balls, about 7 to 9 centimetres in diameter, together weighing 2.5 to 6.5 kilograms. Fresh faeces are yellow brown or buff in colour, but exposed to air turn dark brown within a day or so. Under water the lighter colour remains longer. The smell of rhino dung is not very pungent, much like horse dung.

The faeces are solid, consisting of coarse plant remains, leaf veins and fragments of leaves stalks and twigs. The stalks and twigs are bitten into 1 to 2 centimetre long sections, barked and split lengthwise. These white bits of wood, of uniform length, are typical of rhino faeces, and remain visible for a long period. Even when the rest of the faeces have been decomposed completely, the twig fragments can still be found on the ground. In elephant dung the woody remains are always long and thoroughly masticated so that only bundles of long fibres remain. Tapir faeces are rather similar to those of rhinos, with many coarse fragments, but the balls are much smaller, 4 to 6 centimetres. Old tapir faeces can be mistaken for rhino faeces in areas where both species occur.

Seeds are found only rarely in rhino faeces. Once seedlings (*Mangifera* sp.) were seen to have sprouted from rhino dung, but in the upper Mamas it seems that rhinos are of little or no importance in fruit dispersal.

Old dung heaps are common along the main trails, especially on the higher ridges, where decomposition is slow and there is little litter production in the sub-montane forests. To determine the rate of decomposition, two fresh dung heaps, one at 1250 metres the other at 1700 metres altitude, were marked and inspected on a number of successive expeditions.

The dung at 1250 metres was still clearly visible after almost 4 months, but about half was already covered with dead leaves and a mass of mushrooms. After about 7½ months the heap was still recognizable from the growth of mushrooms, but only a few twig fragments remained.

After 10 months the dung had disappeared, although there were still a few mushrooms growing on the site.

The faeces at 1700 metres were still obvious after two months, with some of the balls still intact, but growing fungi. Even after 9 months the dung was still recognisable with some parts of the balls distinguishable among a patch of twig fragments. After 15 months the dung was three quarters covered with leaves, but the mass of twigs was still clearly visible and mushrooms were still growing there. This site was not visited again, but from its condition at the last inspection it can be concluded that a dungheap at this altitude remains recognisable for at least 1½ years.

In the lower regions of the study area faeces might remain visible for only half a year or less. Dung is soon covered with litter and much of the fresh dung heap is quickly removed by dung beetles. One large dung beetle, about 6 cm in length, is commonly found in rhino dung. At higher altitudes there are few dung beetles, litter fall is less and decomposition is slower. On the higher ridges faeces are still recognisable after 1½ years, and to the trained eye even longer. After the faeces have disappeared, the place can still be recognised from the mass of coral-like tree roots which have formed on the soil surface under the former dungheap. On the ridges with low forest rhino faeces will remain visible for several years. On the well-travelled trails of the main ridges the rhino faeces may be an important source of minerals for these very poor soils.

The more frequent occurrence of dungheaps at the higher altitudes is illustrated by a dungheap count made on the 14th expedition. The numbers of recognisable dungheaps for each section of the patrol trails were recorded and the totals for each altitudinal section were divided by the total length of the inspected sections in that zone. The results are shown in table VII below.

Table VII: Number of dungheaps per kilometre of trail.

Altitudinal zone	no of dungheaps	no of dungheaps per km of trail
1200 - 1400 m	8	0.19
1400 - 1600 m	25	1.28
1600 - 1800 m	22	2.70
1800 - 2000 m	5	3.27

Although we have no reliable figure for the number of defaecations a rhino makes each day, the frequency with which fresh faeces were found indicates that an animal must defaecate several times during the day, as is customary for large herbivores which ingest vast quantities of plant matter. Whenever a fresh track was followed fresh dung was found. The rhino apparently stands still during defaecation, depositing the dung in a neat pile at the side of the trail.

Many faeces were found by rivers and streams, generally in shallow water. Rhinos seemed to choose to defaecate in small streams, but several times faeces was found in the Mamas and other larger rivers, generally in shallow water, but sometimes also in deeper places. When an animal's followed track crossed a stream often faeces were found in the water, and sometimes the rhino had dropped a few balls of dung in every stream it happened to cross. Defaecation in wallows however seems to be very rare; faeces were only once found in a wallow and the rhino had not bathed there.

The rhino's habit of defaecation in streams has been described often (van Strien, 1974; Bonner, 1979). Such behaviour may serve a special function or be a physical reaction brought about by having "cold feet". Because it is difficult to envisage that a stream can be effectively marked with faeces, or that it would be meaningful for the rhino to hide its faeces in the water, it seems more likely that defaecation in water is a purely physical response.

It is worth considering whether or not the Sumatran rhino uses special places for defaecation or has a tendency to defaecate in the vicinity of existing dungheaps. The use of special latrines has been described for the Indian rhino and also for the African species (Laurie, 1978). But while certain authors suggest that the Sumatran rhino always use special places for defaecation, other sources state that they do it only occasionally or only very seldom (van Strien, 1974).

Bonner (1979) writes that the majority of dungheaps in his study area, were located on top or close to other dungheaps. Usually two or three heaps were found together, and the largest concentration consisted of 10 heaps. Flynn (1978) never found dungheaps in Endau-Rampin, and reports that dung is usually dropped in shallow water along the side of a small stream.

During this survey neat piles of faeces were never found, but a few times a small number (4 - 6) of fresh dung heaps were found together. These seemed to be the work of one or more rhinos that had spent a long period in a small area, and had returned to the same spot to def-

feces. In a few cases older faeces were also found at the same place. More usually faeces were dropped along the rhino's route, in a stream or on land. In many instances dung was deposited close to old heaps, giving the impression that the presence of old dung had stimulated the rhino to defaecate. The faeces of a calf were often found close to the cow's and sometimes the cow's dung was deposited on top of the calf's dung.

The distance between dung heaps encountered on the patrol routes were measured for most routes during the first 9 expeditions and some routes on the 16th expedition. The measuring started with the first dung heap encountered and ended with the last on the day's route. A total of 262 dung heaps were recorded. The frequency diagram of the distance classes that were used (0-100 m: 10 m classes, 100-1000 m: 100 m classes, >1000 m: 1000 m classes) is shown in figure 7.2.

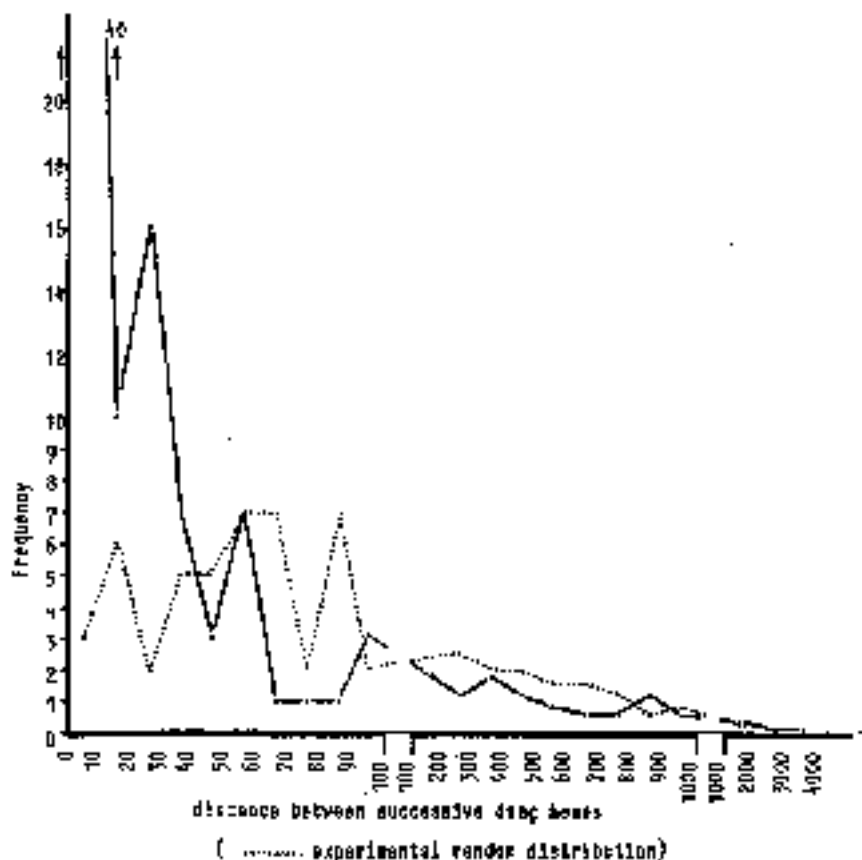

Figure 7.2 - The distances between successive dung heaps along the patrol trails, compared with an experimental random distribution

The dotted line in this figure is an experimental random distribution for the same number of dung heaps over the same length of trails, derived from a random number generator. Dung was encountered close together more frequently than one would expect if it were deposited randomly. Some 10% of the dung heaps are found within 10 metres of another heap (12% closer than 5 metres). In the field almost 30% of the heaps are less than 30 metres from the next, while in the experimental random distribution the expected figure is only 5%. These figures suggest that the Sumatran rhino is indeed stimulated to defaecate by the presence of other, usually old, dungheaps.

7.6 - Urine and urination

Rhino urine has a characteristic scent, pungent but not unpleasant and with a sweetish tinge. The scent is persistent and even to the human nose is still perceptible after some days if the rains have not been heavy. The urine is often sprayed over the vegetation and drops can be seen on the leaves. When fresh the urine is virtually colourless, but later turns brown or reddish and becomes glutinous as it dries. When urine is sprayed over soft or young leaves they wilt and become blackish or purplish.

Although it is known from captive animals that both males and females can squirt their urine backwards (van Scrien, 1974), the finding of sprayed urine is often regarded as proof of the animal's masculinity. This is certainly not justified, although males (whose penis is directed backwards in rest) may squirt more frequently than do females.

Borner (1979) found that for 95% of the urinations the urine was sprayed backwards over the vegetation. This suggests that squirting is customary for all rhinos, male and female, and that downward urination is exceptional. In most cases noted in this study the urine had been sprayed over the vegetation and soil and only rarely formed a clear wet spot on the ground. On two occasions females are known to have made a scrape with sprayed urine; in one case the female was accompanied by a calf (see chapter 7.4).

The white slime in the urine, described by Borner (1979) was recorded only once during this study, not in an urine spray, but on the ground. It was produced by a female in the Pinus area.

CHAPTER 8 - FEEDING AND THE MINERAL BALANCE

8.1 - The food

Traces of feeding were rarely found during this survey. Feeding does not necessarily take place along the big game trails, and therefore feeding sites were generally only found when a track was followed outside the patrol network, but little time could be spared to follow single tracks.

Samples were taken of any plant eaten by a rhino for identification and the size and the parts eaten were recorded. The samples were preserved in alcohol and afterwards dried. During the study some 150 samples were collected and identified by the staff of the National Herbarium of the Netherlands in Leyden, where the samples are preserved. As most of the material was leaves without flowers or fruits, many samples could only be identified tentatively to family or genus.

The Sumatran rhinoceros is a typical browser, eating leaves and stems of broad-leaved herbs, shrubs and trees. Food is usually taken from some distance above the ground and rhinos also break down saplings and small trees. A large amount of fodder occurs within reach of a rhino in the mountain forests of Gunung Leuser and the animal appears to be an opportunistic feeder, taking a mouthful here and there, rather than feeding intensively and systematically from one source.

Periods of feeding seem to be alternated with periods of travel when only occasionally a mouthful is taken along the route (see chapter 7.2). When feeding the rhino moves in a zigzag fashion or in wide circles, feeding on the softer parts of the plants within reach. It seems not to be very selective when feeding and samples all the plants along its route. Much of the undergrowth in a feeding area is flattened and trampled by the rhino, and the devastation remains visible for many weeks.

It is difficult to speak about special feeding areas, although some areas offer much more fodder for a rhino than others, and when freshly used give the impression of a favourite place because of the damage done to the undergrowth. But visits to such 'feeding areas' may be months or even years apart, much longer than is needed for recovery of the vegetation.

It is often stated that leaves and twigs of saplings and small trees are the favourite food of the Sumatran rhino (van Strien, 1974; Flynn, 1980), but that is not the case in the upper Mamas. Rhinos certainly take a lot of this type of food, but they browse more often and more intensively on the rich undergrowth of large herbaceous and suffruticose plants that is common in the upper Mamas. In these areas they do not touch the saplings and small trees, but feed exclusively on the soft leaves and succulent stems of the groundcover plants.

The canopy in the submontane forest is not so high and dense as in the lowlands, with more vigorous plant growth at ground level. On the ridges the undergrowth is meagre, probably because the soils are dry and leached, but elsewhere on the slopes, especially in the valley bottoms, the undergrowth is lush. Here the soil is covered with a dense layer of soft, shiny green plants with fleshy leaves and thick succulent stems, some one to one and a half metres high, and the rhinos feed on the succulent leaves and upper stems.

The Sumatran rhino in the Mamas appears to prefer the herbaceous undergrowth (which also has a higher content of minerals - see chapter 8.3) over the leaves and twigs of saplings and small trees, but where the undergrowth is thin rhinos turn to browse on the saplings. In the Endau-Rompin area in Malaysia almost 98% of rhino food was saplings (Flynn, 1980), but this area lies at a lower altitude, and the undergrowth is thinner than in the Mamas.

Plants from the family *Urticaceae* are well represented in the undergrowth and in the rhino's diet, particularly *Elatostema* spp., which is probably the most frequently eaten plant. Other *Urticaceae* were sampled more than once - *Pilea*, *Urtica grandidentata*, *Boehmeria*, *Cypholophus*, *Pouzolzia*. Other popular foods, for which the rhino seemed to have a preference are *Cyrtandra* and *Chirita* spp. (*Gesneriaceae*), and to a lesser extent *Strobilanthes* spp. (*Acanthaceae*), *Piper* spp. (*Piperaceae*) and *Begonia* spp. (*Begoniaceae*). Other herbs eaten include *Chloranthus* (*Chloranthaceae*), *Impatiens* (*Balsaminaceae*), *Psychotria* and *Maschaleocorymbus corymbosus* (*Rubiaceae*), *Blumea* (*Compositae*), *Forstera* (*Commelinaceae*), *Homalomena*, *Schismatoglottis* and *Raphidophora* (*Araceae*).

In open clearings and along the river banks the undergrowth is thicker than in the forest, some two metres or more high, but composed of similar plants. Several times rhino were found to have fed here on many of the species mentioned above. Occasionally the plentiful giant ginger, *Zingiberaceae*, were eaten. The rhino chews on the thick ginger stems to extract the soft and juicy pith. Rhinos also ate the heart of the giant *Colocasia* (*Araceae*). Wild banana (*Musa*), very common in places, was never eaten by rhino. These huge soft-stemmed plants, a favourite food of the elephants, are not touched by the rhino.

Rhino also fed in places where the forest was regenerating after tree falls or landslides. The thick mass of herbs, shrubs and soft-wooded trees provides ample fodder and feeding in these areas can be rather intense and concentrated. Here the following herbs and smaller shrubs were sampled: *Begonia* (Begoniaceae), *Melastoma malabothricum* (Melastomaceae), *Microglossa trifolia* and *Eupatorium inulifolium* (Compositae), *Cyttandra* (Gesneriaceae), *Comphosenna* (Labiatae), and a number of larger shrubs, lianas or small trees: *Kadsura* (Schisandraceae), *Debregeasia* (Urticaceae), *Picus* (Moraceae), *Macaranga* and *Sarcococa* (Euphorbiaceae), *Meliosma lepidota* (Sabiaceae), *Sambucus* (Caprifoliaceae), *Turpinia* (Staphyleaceae), *Clerodendron* (Verbenaceae).

On the ridges and higher slopes, where ground cover is thin, the rhino took a great variety of food plants. Feeding there was usually less intense with the animal moving in a more or less straight line through the forest, breaking most of the saplings and small trees it passed. The leaves and the younger parts of the stems are bitten off and eaten. Sometimes only a few branches are eaten, at other times the whole crown is systematically defoliated.

Most of the saplings are snapped off some distance above the ground. The rhino usually breaks the trunk by biting and not by pushing. Teeth marks are often visible in the bark above the break. Sometimes the horn is also used to bring down trees, occasionally a branch or tree was found that had apparently been pulled down by hooking the horn behind it. The estimated lengths of the saplings and small trees on which rhinos browsed varied from 2 to about 12 metres, with an average of about 4.5 metres ($n=52$). The thickest specimens broken were about 8 cm in diameter.

A great many different species of saplings were eaten and only a few were recorded more than once. Only three genera - *Garcinia* (Guttiferae), *Linociera* (Dieaceae) and *Styrax* (Styracaceae) were collected on several occasions and these plants seem to be rhino favourites. Other trees that could be identified are: *Disepalum anomalum* (Annonaceae), *Horsfieldia glabra* and *Knema sumatrana* (Myriacaceae), *Litsea*, *Dehaasia* and *Cinnamomum* (Lauraceae), *Prunus grisea* (Rosaceae), *Hemisclopla trimeria* (Flacourtiaceae), *Saurauia* (Saurauiaceae), *Calophyllum* (Guttiferae), *Schinus molle* (Theaceae), *Trigonobalanus verticillata* (Fagaceae), *Eugenia* (Myrtaceae), *Leptomycbia* (Sterculiaceae), *Santiria laevigata* (Bursaraceae), *Dysoxylum*, *Chisocheton* and *Cocca surenii* (Meliaceae), *Mallotus*, *Endospermium*, *Securidaca* and *Alchornea* (Euphorbiaceae), *Mangifera quadrifida* (Anacardiaceae), *Mastixia trichotoma* (Coronaceae), *Vaccinium korthalsii* (Ericaceae), *Rapanea* (Myrsinaceae), *Pavetta*, *Lasianthus*, *Urophyllum*, *Randia* and *Ophiothlas* (Rubiaceae), *Ehretia acuminata* (Berberidaceae), *Podocarpus imbricatus* (Gymnospermae - Podocarpaceae).

The small, stemless thorny palms common in the forest, especially on the lower parts of the ridges, were rarely sampled. Occasionally the heart of a palm or a thick rattan (*Calamus*) was eaten. Pandanaceae are rare in the Mamas and a rhino fed only once on a *Freylinia*. Once the top of a sedge, *Scleria* (Cyperaceae), was eaten in the forest, but usually grasses and sedges are not eaten. The few open marshy places are covered with a thick mat of grasses (mainly *Isachne*) and sedges (*Scirpus mucronatus*, *Cyperus* and some *Carex*), but rhinos were never found to have grazed there and these sites were usually avoided (see also chapter 5.4.2).

Fruits are not an important part of the rhino's diet in the Mamas, and fallen fruits are seldom found. Wild mangoes (*Mangifera* - stones were found once in faeces, see chapter 7.5) are very rare and the only fruits that are often found on the ground are kandi (*Garcinia*). These fruits are eaten by deer and pigs, but rhino were never known to take this, at times plentiful, food.

Signs of feeding were found in all parts of the study area and at all altitudes, up to 2000 metres. Above 1600 metres feeding appeared to be less frequent, and it was never observed in the stunted montane forest and the sub-alpine shrubs on the highest ridges. Rhinos traverse these areas on their wanderings and push through the scrub, that is for humans almost impenetrable, but they do not feed on the small hard leaves of the montane plants. Rhinos do feed however on the undergrowth and saplings at similar altitudes on the slopes and in the valleys where the forest is still fairly high.

8.2 - Availability of food

In an area like the upper Mamas study area there seems to be an abundance of food the year round. Rhino food plants are common over most of the area, and one gets the impression that a rhino does not need to go very far to fill its stomach. Although the dark-green understorey seems lush, growth there is very limited. Saplings that have been broken off along the trails produce only a few meagre soft sprouts after many months, and growth is rapid only along the open river banks. There a freshly cut trail will be overgrown in a couple of weeks, but in the forest it remains visible for many months.

A detailed analysis of the amount of food available for the rhino and of the productivity of rhino food plants was beyond the scope of the present study. To get a rough idea of these

parameters a few samples were taken and weighed. At two locations a small plot was made in the more or less homogeneous vegetation. One location was under a high closed canopy, with rather meagre undergrowth. The other was close to a river with lush undergrowth. From one half of the plot all undergrowth was collected, from the other half only the leaves and top shoots that a rhino would eat. After about three months all new growth on the plots was collected and weighed. The plots were not fenced, but it is certain that they were not visited by rhino in the meantime, nor were there signs of browsing by animals.

From the total amount of undergrowth (about $\frac{1}{2}$ to $1\frac{1}{2}$ kg per sq m) the leaves and stems suitable as rhino food weighed between 260 and 520 grammes (fresh weight) per square metre. Regrowth of leaves and stems varied from 0.7 (in the forest) to 3.8 (near the river) grams per day per square metre. It seems from these figures that the average production of browse suitable for the rhino is probably not more than 1 gram per day per square metre. There are a few hundreds of grams of browse standing on each square metre, but it takes a long time, up to a year or so, for replacement.

Very little is known about the energy requirements of a Sumatran rhino. A young rhino female captive in Malaysia consumed about 50 kg of leaves and 1 to $1\frac{1}{2}$ kg of pelleted dry food per day (pers. comm. Mohd. Khan). The basal metabolic rate of a mammal in kcal per day is approximately seventy times the three-fourth power of the body weight in kg (Moore, 1973). A rhino of 900 kg weight requires a daily intake of about 57 kg of browse (fresh weight), if for maintenance it needs about twice the basal metabolic rate, and if browse contains 80% moisture and 2000 kcal per kg dry weight.

The Sumatran rhino may have an average consumption of somewhat more than 50 kg of browse per day. With a production of 1 gram of browse per day per square metre, one rhino would require a range of at least 5 or 6 hectares to provide sufficient food. In the Mamas there is about one rhino per 700 hectares (see chapter 5.3.1), which seems to confirm the impression that there food is abundant for the present rhino population. On the other hand the slow rate of reproduction with long periods between successive births (see chapter 6.4) implies that food may be a limiting factor. It may be that it is not the quantity of food available but the quality that is a limiting factor for reproduction and population levels.

5.3 - The mineral balance

All rhinos in the study area paid regular visits to mineral-rich springs and the obvious conclusion is that they do this to take in extra minerals to offset an imbalance or deficiency in their diet. From other studies, mainly referring to arid areas in Africa and America, it appears that animals using saltlicks are primarily seeking extra Sodium. Tropical vegetation is usually low in available Na and may contain inadequate levels for herbivores. Elsewhere it appears that animals are seeking other elements (Mg, P) or clay minerals (Kreulan & Jager, 1984). For the rhinos in Gunung Leuser clay minerals cannot play a role, because they usually only drink saline water at the licks.

On one occasion a rhino entered one of the camps and had scraped in the ashes of the fire. Other herbivores (deer, serow) did the same, and presumably ashes are ingested. In the Sungei Dusun reserve in Malaysia rhino come regularly to the ashes of the cooking fire at the guard post (pers. comm. Mohd. Khan).

Samples of all the saltlicks and of several foodplants were analysed for the elements that are most important for animals. Mineral requirements for rhino are not known and therefore the mineral requirements for the horse are used for comparison (Maynard, Loosi, Hinz & Warner, 1979). The anatomy of the alimentary tract of the Sumatran rhino is in many aspects similar to the horse's (Garrod, 1873). The foodplant samples were dried in the sun or in a tin over a fire. The mineral contents of the plant samples were analysed by the laboratory of the Pusat Penelitian dan Pengembangan Ternak, Cijawi, Indonesia. The samples of the saltlicks were analysed by the Analytical Laboratories of P.T. Superintending Company of Indonesia in Jakarta.

5.3.1 - Mineral contents of the foodplants

Three of the foodplant samples were a mixture of species that are usually eaten by rhino. Two (I and II) consisted of the tops of the plants collected in the plots described above, the third mixture (Medan Badak) consisted of tops of plants eaten by a rhino in the forest fringe around Medan Badak (see chapter 2.3.2). The other samples were all taken from plants freshly browsed during the 17th expedition. The species were identified by the Herbarium Bogoriensis in Bogor.

Table VIII: Mineral contents of foodplant samples.

Sample	Mineral composition (in per cents on dry matter basis)							
	Ash	Crude proteins	Ca	P	Mg	K	Na	Mn
Undergrowth								
Mixture I	15.92	15.63	5.01	.22	.53	3.31	.082	.011
Mixture II	14.45	11.63	3.61	.16	.49	3.85	.064	.0129
Mixture Medan Badak	28.04	24.13	6.76	.37	.55	6.31	.055	.0208
<i>Elatostema</i> (Urticaceae)	18.64	6.38	4.40	.09	.36	.89	.01	-
Average for undergrowth (Standard deviation)	19.26 (6.10)	14.44 (7.49)	4.95 (1.34)	.21 (.12)	.48 (.09)	3.68 (2.71)	.053 (.031)	.0149 (.0052)
Saplings								
<i>Disepalum anomalum</i> (Annonac.)	4.14	9.75	.51	.07	.37	.91	.01	-
<i>Ficus ribes</i> (Moraceae)	16.19	13.29	3.06	.21	.36	.87	<.01	-
<i>Garcinia</i> (Guttiferac)	6.49	7.81	1.63	.08	.36	.38	<.01	-
<i>Hemiscocolopia trimera</i> (Flacourt.)	8.05	5.56	2.29	.08	.29	.74	.01	-
<i>Schinus molle</i> (Theaceae)	5.29	11.38	1.17	.09	.22	.63	<.01	-
<i>Styrax agretis</i> (Styracaceae)	6.08	14.13	1.35	.13	.21	.83	.01	-
<i>Styrax paralleloneurum</i> (Styrac.)	3.83	11.80	.63	.07	.33	.56	.10	-
<i>Toona sureni</i> (Meliaceae)	7.54	6.19	1.85	.18	.32	.59	.01	-
Average for saplings (Standard deviation)	7.20 (3.91)	10.24 (2.94)	1.56 (.85)	.11 (.05)	.31 (.06)	.50 (.24)	ca.02	-
Average all samples (Standard deviation)	11.22 (7.43)	11.64 (5.01)	2.69 (1.93)	.15 (.09)	.37 (.11)	1.59 (1.89)	ca.03	-
Faeces								
(Average 5 samples) (Standard deviation)	12.90 (4.33)	9.32 (1.76)	1.83 (2.69)	.24 (.03)	.26 (.08)	1.58 (.95)	.06 (.04)	.134 (.044)
Minimum requirements in diet for the horse 1)								
Maintenance		8.5	.3	.2	.09	.4	.35	.004
Gestation		11.0	.5	.35				
Lactation		14.0	.5	.35				
Growth					.1	.5	.35	.004

1) After: Maynard, Lonsj, Hintz & Warner, 1979.

While the crude protein contents of the undergrowth and the sapling samples is not very different, the mineral concentrations in the undergrowth samples are considerably higher, which might explain the rhino's preference for this type of browse. For all elements analysed the average concentration in the undergrowth samples is almost twice the concentration in the saplings. If we compare the average concentration of minerals in the samples with the minimum requirements for the horse, the supply of only two elements (phosphorus and sodium) seems to be insufficient. The concentration of the other elements and the proteins is more than sufficient for adequate nutrition.

The concentration of phosphorus in the rhino food samples is slightly below the minimum requirements for the horse. During pregnancy and lactation the animal's requirements of phosphorus are considerably higher and in that period an additional supply might be beneficial.

The ratio of calcium to phosphorus in the diet must be considered, because the absorption of one of these elements is influenced by the concentration of the other. Ideally the intake of both elements should be similar, but a mature horse can cope with a calcium to phosphorus ratio of 6 : 1, if phosphorus intake is sufficient (National research council, 1978). In the rhino's food the ratio is about 18 : 1 and the phosphorus intake is low, so there may be an imbalance in the calcium - phosphorus metabolism, and extra phosphorus may be beneficial, especially for a pregnant or nursing female.

Flynn (1980, 1981) reports on mineral analyses of a large number of rhino foodplants (mainly saplings) from Endau-Rompin, Malaysia. The average contents of ash, crude proteins, potassium and magnesium are similar to the values found for the upper Mantas, but the average contents of calcium (.89) and phosphorus (.072) are much lower in Flynn's samples. Nevertheless saltlicks are unknown in Endau-Rompin and the rhinos are apparently able to survive on a low phosphorus diet, unless they have some unknown source of minerals. Flynn (1980) suggests that fruits might be an important source of phosphorus.

In the Mamas the average concentration of sodium in the rhino's food is more than ten times lower than the recommended minimum dosage for the horse. The actual requirements of sodium have not been determined for the horse (National research council, 1978), but additional salt is recommended even though the sodium concentrations in horse fodder are usually between .1 and .5 %. For cattle of weight up to 300 kg the minimum dietary concentration of sodium is .06 % of dry matter weight (Kreulen & Jager, 1984). An average concentration of .03 % sodium in the diet could lead to deficiency.

8.3.2 - Mineral contents of the saltlicks

From most saltlicks water samples were taken for analysis of the mineral contents. As a control water was also analysed from the Mamas river at camp Central. Water and not soil samples were taken, because it appeared that the rhino usually only drank water, from puddles on the saltlick or directly from the spring. Sometimes rhinos dig with the horn, but there were no signs that the rhino had actually eaten soil. The results of the analysis are shown below in table IX.

Table IX: Mineral contents of the saltlicks.

	Concentration in Mg per Litre										
	Ca	PO ₄	Mg	K	Na	Mn	Pb	SO ₄	Cl	NO ₃	CO ₃
Mamas	12.38	.053	2.17	.36	.66	trace	.055	4.57	5.04	.30	und.
Saltlick											
2	214.18	.054	128.11	31.03	55.38	.016	.055	11.04	21.86	1.48	und.
3	120.27	1.36	141.27	30.73	55.77	und.	.11	39.96	21.86	1.48	und.
4	38.26	1.03	2.33	1.02	38.26	trace	.055	14.84	8.41	.70	und.
5	41.20	.36	6.87	.42	39.38	trace	trace	50.23	21.86	.52	und.
6 A	27.71	-	5.35	1.85	107.27	trace	trace	31.21	5.04	1.14	und.
6 B	55.28	120	7.09	1.26	72.73	trace	trace	42.62	65.59	.84	und.
Average	82.82	24.56	48.50	11.05	61.47	-	-	31.65	24.10	1.03	-

(und. = undetectable)

There is much variation in mineral composition between the saltlicks. All samples were high in calcium, sodium and sulphate, but there was considerable variation in levels of magnesium, potassium and phosphate. Phosphate is only high in saltlick 6 B (the large saltlick east of the Sungai Pinus), where by consuming a few litres of water a rhino may make a significant addition to its intake of this mineral. But nursing females, whose need for phosphorus is highest, were never found at this lick. In the other licks the phosphorus contents are much lower. Even at saltlicks 3 and 4, that were visited by females with calves, the amount of 1 milligram per litre seems insignificant compared to the amount found in rhino food plants which contain about 1500 milligrams per kg of dry matter. Therefore it seems unlikely that the need for extra phosphorus is the reason why rhino use saltlicks.

The concentration of sodium in the saltlick water is much higher (at 61 mg/l about 100 times), than the concentration in the Mamas river. This is not a high sodium content (seawater contains about 11030 mg/litre). One litre of water from the saltlick contains only as much sodium as 1 kg of rhino fodder. However the minerals in the saltlick water are mainly in solution and are readily absorbable, while much of the minerals taken in the food are excreted unabsorbed (see the faeces samples in table VIII).

Most rhinos visit a saltlick once a month, but females with calf visit on average once every two weeks and some males might make more frequent visits (see chapter 5.6). It is difficult to envisage the importance of imbibing a few litres of saltlick water every month or even every two weeks. Even if the animal were to drink a bucketful of water every time it went to the saltlick the amount of minerals it would obtain is much less than from a day's intake of fodder. Although there is probably a deficiency of sodium in the diet it is unlikely that rhinos visit the saltlicks for only a few hundred milligrams of sodium.

The fact that all rhinos visit a saltlick regularly is a clear indication that saltlicks are important to the rhinos. The increased frequency of visits by nursing females, whose requirements for minerals are higher, point to a possible physiological benefit from the intake of saltlick water. It may be access to extra minerals during the nursing phase that makes the female and calf stay in the neighbourhood of the saltlicks, but visits during later life may serve another function. The physiological benefits of the minerals in the saltlick water will be short-term, if

there are any, but the visits of adult rhinos to a saltlick might be more a question of a habit acquired during the first years of life, the continuation of which is stimulated by the experience that saltlicks are good places to "meet" other rhinos (see chapter 6.2). For the adult rhino the social contacts made at the saltlicks may be more important than the minerals supplied by the saltlick.

CHAPTER 9 - SUMMARY AND EVALUATION OF THE RESULTS

The Sumatran rhino is solitary for most of its life. The home range of a rhino overlaps with the home ranges of several other rhinos and animals occasionally meet, but they do not stay together for any length of time. It may be that young sub-adults, in their first years of independence, form loose associations occasionally, but later they travel alone, wandering round their vast home ranges. A male and female seem to come together for only a short period for mating. Non-breeding females may have very little contact with other rhinos, because they occupy a relatively small range and leave it only occasionally to visit a saltlick.

The adult males seem to be more actively searching for contact. They cover a large area and are very active around the saltlicks, apparently searching for signs of other rhinos. Although males have more frequent contact with other rhinos, they never associate with an other rhino for more than a few days. If longer-lasting bonds were usual, the tracks of two or more animals walking together would be found more frequently.

A rhino calf remains close to its mother till they separate. When very young the calf stays very close, but older calves do not wander more than a few metres away from the trail of the cow. When the calf is about 16 to 17 months old it separates from the cow. Maternal care for the young is limited to the infant's period of rapid growth, and when the youngster has reached about three-quarters of the adult size, it leaves the cow. There may still be occasional contact between the cow and her independent offspring, but most of the time the young rhino travels singly.

While nursing a calf the female rhino moves from her non-breeding range higher on the slopes, to the vicinity of a saltlick. Already during pregnancy the females may make more frequent trips to the saltlicks. The calf is probably born close to a saltlick and during the whole period of nursing cow and calf remain in a relatively small area, about 10 to 15 sq km, around one of the licks. The pair visit the lick about once every three weeks, about two to three times as often as non-breeding females and sub-adults. When there are several females with a calf around one saltlick, their ranges usually overlap and the pairs may meet occasionally. Tracks criss-cross the area, and several routes are used to approach the saltlick.

After leaving the cow the calf remains in the area where it was nursed. The cow returns to her non-breeding range, further away from the saltlick. The newly independent rhino, the young sub-adult, initially uses a relatively small area, 10 sq km or less, part of the range it used with its mother. The young rhino roams over the area intensively, often returning to the same places; it seems as though the animal is familiarizing itself with the location. The animal gradually extends its range into adjacent areas, where it was never found with the cow. For at least two or three years the young sub-adults remain in the neighbourhood of the place where they were born and nursed. During this time they grow slowly, and after about three years their footprints are still smaller than those of an average adult and clearly recognisable as from a young rhino.

The older sub-adults, aged at least six or seven years by the end of the study occupied relatively large ranges and many were only found occasionally. Animals gradually extend their home range for a number of years with older sub-adults travelling widely into new areas, probably to find a gap between the existing adult ranges. It seems to take several years before a Sumatran rhino is adult and has established a permanent home range. A young rhino remains in the 'nursing area' till it is at least four years of age and it is probably not sexually mature before the age of 7 or 8 years.

The adult rhinos have permanent home ranges which are spread rather evenly over the study area, with the centres of the home ranges on the major ridges. The non-breeding females remain in relatively small ranges, no more than about 10 sq km, on the higher parts of the ridges, away from the valleys and the rivers. The tracks of non-breeding females were rarely met, usually only when the animals visited a saltlick and it appears that these normally travel little along the large game trails, perhaps once every 6 weeks to visit a saltlick. The rhino then follows a specific route to the saltlick and returns to its home range immediately, usually along the same route.

The ranges of the females in the non-breeding period seem to be well separated and the records do not show any overlap in range, except close to the saltlicks. The paucity of records for non-breeding females makes it difficult to draw firm conclusions, but it seems that they have more or less exclusive territories. It is not clear how the spacing of the female home ranges is accomplished, but it may be that females tend to avoid areas where other females have left tracks and signs. Nursing mothers with calves do not avoid other female's tracks in the vicinity of the saltlick.

Although we have no precise records it seems that the interval between births is at least 3 to 4 years, somewhat longer than the time that a female carries and nurses a calf. It may be that the long birth interval is necessary for the female to build up sufficient reserves for another reproductive effort. Although rhino food plants are abundant, they are not particularly

rich in nutrients and minerals and the female probably needs a period of limited mobility and seclusion to recover condition between births.

Adult males range over much larger areas, 25 to 30 sq km or more. It seems that male home ranges have a core area where most activity is concentrated. Peripheral areas are visited less frequently and then the animal often follows the game trails for long distances. On average males visit the saltlicks about as often as sub-adults and non-breeding females, but males with ranges close to the lick, visit them much more often. From the saltlicks males usually make several forays in different directions, giving the impression that they are searching for other tracks. Males visit a regular saltlick, but may occasionally also travel to other licks.

Male ranges overlap considerably, but it appears that the core areas are distinct and rather evenly spaced over the area. There might be some form of hierarchy among males, because some animals make more marks along the trails than others. Visual and olfactory signs are left by rhinos along the large game trails. They include soil scrapes, faeces, sprayed urine and bent or twisted saplings, in various combinations. All rhinos mark in this way, both males and females. Young sub-adults rarely mark, while the older sub-adults are the most active markers of all groups. Marking may be associated with the process of establishing a permanent home range. The more complicated signs, those consisting of soil scrapes, bent saplings, faeces and/or urine are usually only made by males, and could indicate male territoriality.

Saltlicks are an important focal point for rhinos in the Mamas study area. Each lick is visited regularly by several rhinos, and each rhino appears to visit one particular saltlick, not always the one closest to the centre of its home range. A rhino generally uses one particular route to the licks, following it consistently on every visit. Each of the six saltlicks discovered in the study area is used by 5 to 7 different rhinos, each animal visiting a lick on average 6 to 7 times per year. The consistency with which a rhino visits a certain lick suggests that all rhinos using a saltlick may be related. Sadly many rhinos also end their life near a saltlick, because hunting activities are centred at these places.

Rhinos drink mineral-rich water at the licks most probably to compensate for a deficiency or imbalance in the mineral composition of the food. In a number of samples of plants eaten by rhinos, the sodium (Na) concentration was found to be very low, also the phosphorus (P) concentration, especially in relation to the calcium (Ca) concentration, was low. If there is a deficiency it is probably in one of these elements. The mineral concentrations in the water of the saltlicks vary considerably. All have about 100 times more sodium than surface water, but the concentration of phosphorus varies between the licks. The amount of minerals that a rhino may imbibe at each visit to a lick is small, less than in a day's intake of fodder. So it is not clear how important one visit a month is for maintaining the animals mineral balance. It is more probable that for adult rhinos the social function of a lick, as a place for meeting other rhinos, is more important than the extra minerals.

The daily movements of the rhino seem to be controlled by the terrain, and on the slopes they follow the contours or ridges. The larger rivers are important boundaries for rhino. Rhinos have no problem in crossing the rivers, and do so frequently, but they usually do not stay on the other side, but recross the river. The bigger the river the more important it seems to be as a boundary, and the Mamas river forms the boundary of the home range of almost all known individuals. The tracks of only two older sub-adults were found on both sides of the river. The big game trails on the ridges are more often used by the rhino for climbing than descending. This and the habit of turning back at the major rivers, means that a wandering rhino automatically turns back to the centre of its home range, which is usually located on one of the main ridges.

When not following a trail the rhinos more or less follow the contours of the slope, crossing small streams and minor ridges. Animals often follow wide trails for some distance or may leave it to wander over the slopes. As they travel rhinos browse or take a mudbath in a wallow. Faeces and urine are found along the animal's trail and occasionally the rhinos lie down.

The Sumatran rhino feeds on leaves and twigs of a great many plant species. Fallen fruits are also taken, but these were rare in the Mamas area. When feeding the animal moves in a zigzag fashion through the forest, often going around in circles, browsing on the soft parts of the plants within its reach. Periods of feeding alternate with periods of travel, when the animal often walks several kilometres without feeding, except for an occasional bite from a plant along the trail. When feeding the rhino seems to prefer places with a dense undergrowth of soft, juicy plants. In the mountain forests of Gunung Leuser there is very dense undergrowth along the streams and on the lower slopes, and these seem to be the favoured feeding places. Rhinos also feed on the young regrowth on landslides and at tree falls. Where there is less undergrowth the rhino feeds on small saplings, pushing them over to browse on the crowns, but this type of food appears to be less favoured and also contains less nutrients and minerals. Feeding occurs mainly at night and in the early morning.

Rhinos feed on a great many plant species taking only a little material of anyone species. The rhino does not appear to be selective while feeding, but a few species seemed to be favour-

ites, while others, like wild bananas, are ignored. There seems to be abundant food for the rhino in the upper Mamas. Over a large part of the area the forest supports dense undergrowth with numerous accessible saplings. The standing crop of rhino food plants is certainly large, but the production of new growth is very slow. An area that has been browsed and trampled by rhino, takes a long time to recover. This might explain the need for the continuous travels of the rhino. Although productivity is low in the understory there seems to be considerably more food available than can be consumed by the present rhino population (estimated at 13 to 14 rhinos per 100 sq km), and it is probably not the quantity but the quality of the food that is a limiting factor for the population.

Rhino faeces are often dropped in streams or along the rhino's trail. The faeces, with characteristic twig fragments, remain visible for a long time, especially at the higher altitudes. The Sumatran rhinos prefer to drop their faeces close to other faeces, but large dung piles are not made. All animals, male and female, normally spray urine backwards over the vegetation.

The wallows are a characteristic feature of any rhino area. The pits are often used for a long time and rhino's digging in the banks give the wallow a characteristic shape. It seems that a rhino takes a bath at least once a day and sometimes several times a day. Wallows are used day and night, but rhinos probably spend more time in wallows during daytime. Each wallow is used by several rhinos and on average the wallows along the main trails were used about 4 times per year.

The major difficulty in interpreting the data was the disjoint and patchy nature of the records for most of the rhinos. For many individuals there were only few records, spread out over a long period of time; this not only made the identification of the plastercasts more difficult, it made it more difficult to draw conclusions about rhino behaviour and activity from the available data.

The remoteness and inaccessibility of the area and our financial limitations made it impossible to maintain a permanent presence in the study area. Because this study focussed on tracks we decided to use the days in the study area to find as many tracks as possible. This required the survey team to keep on the move and left little time for more detailed study of single tracks. By following tracks for a longer period and distance one can discover much about the daily routine of the rhino, information that could only be gathered incidentally in this study. Ideally one should monitor movements of the rhino over a large area and also follow single tracks for a number of days.

Interpretation of the data is limited by the difficulties in ageing the tracks. One can only estimate the time and the duration of the various behaviours and activities of a rhino from very fresh tracks or when the animal is actually met. These occasions are very rare and normally one can only guess the approximate age of the tracks. Therefore track studies are of little value for studying the animal's daily rhythm, unless one can trail single animals for a few days. With very experienced trackers it is possible to follow a rhino closely, without disturbing it, but this requires a more permanent presence in the study area.

CHAPTER 10 - RECOMMENDATIONS FOR FUTURE STUDIES

Among the first things one wishes to know for study or management of a rhino population, is its status, more specifically how many animals are there and where. Establishing the extent of the rhino population is relatively simple. By compiling reliable reports one can get a rough idea of the rhino's distribution and the data can be complemented by making short field-trips to various localities to check whether rhinos are present or not. An experienced observer will be able to see in one or two days if rhino have recently been in the area or not. For a reliable estimate of numbers however, much longer and more thorough studies are needed.

Other field studies on Sumatran rhino (Borner, 1979; Flynn & Abdullah, 1983) and Javan rhino (Schenkel & Schenkel-Mulliger, 1969) used simple census techniques based on print width measurements; such methods do not give very satisfactory results. In this study a much more refined technique was employed using plastercasts of foot prints, but the field work and later evaluation was complicated and very time-consuming. Studies of several years are unrealistic for every rhino area, and usually a researcher can spend no more than a few weeks surveying any area. Accordingly results and experiences of the present study were analysed with the intention of developing a quick census method to give reliable estimates of rhino numbers.

In this chapter the techniques used to estimate the number of rhinos present in an area will be discussed and compared. The value of print width measurements will be analysed by comparison of the results of a simulated print width analysis on the material collected in the study area, with the results of the plastercast analysis. The section concludes with a discussion of the usefulness of the different standard measurements and track counts for censusing Sumatran rhino populations.

10.1 - Plastercasts in comparison to print measurements

The first scientist to do a systematic study of a rhino population by means of track analysis was Strickland (1967), who studied the rhinos in the Sungai Dusun reserve in Malaysia. He measured the width of prints, from edge of outer toe to edge of inner toe, but found great variability in print width depending on soil type. He identified three individual animals (prints of 16-18 cm, 19-21 cm, 21-23 cm), but was convinced that there were more individuals present in the reserve.

During his survey of the Gunung Leuser Reserve, Kurt (1970) also used track measurements. He measured the width of the print, the width of the front hoof and the width of the side hoofs, of clear, complete prints in hard soil. Although he does not elaborate on the criteria used for distinction between different individuals, it is clear from the values given in table 7 of his report that he accepts an individual variance in print width of up to 7 cm, and that he considers a difference of 2 or more cm between the means as sufficient for distinction. No estimates of numbers of rhinos or density were given.

From 1973 till 1975 Borner (1979) studied the Sumatran rhino in an area that partly overlaps the southern extension of the present study area. He measured more than 1000 prints from 67 fresh tracks. He measured the width of the hindfoot, and also, when possible, the width of the forefoot. He measured at least 30 prints on hard soil, and considered two tracks to be made by different animals, if the standard deviations of the mean hindfoot width did not overlap. The difference between hindfoot and forefoot width was used to give additional clue. He could identify 6 single individuals and 5 cow and calf pairs in his study area. In figure 23 Borner (1979) gives a graph of means (19.5 - 23 cm) and standard deviations (0.3 - 1.0 cm) of 22 different tracks of solitary animals. A difference in the means between two tracks of about 1 cm appeared to be large enough to indicate a different rhino.

Borner (1979) does not attempt to calculate a density from the 16 individuals he could identify from print size in his study area, but he gives a 'guesstimate' of 20 to 40 animals for the 1000 sq km core area in Gunung Leuser. This implies that, using the formula for the calculation of the population size as given on page 62 of Borner's paper, an individual rhino's home range would be between 500 and 1000 sq km.

From 1975 till 1980 Flynn conducted several censuses in the Endau-Rompin area in central Malaysia. Several survey teams simultaneously surveyed the large study area following regular routes and taking measurements of rhino tracks. This method has also been used in the Ujung Kulon reserve to census Javan rhino (Schenkel & Schenkel-Mulliger, 1969). Both the size of individual prints and distance between the tracks is measured. Whenever possible 10 clear prints are measured on firm, level ground and soil condition and age of the tracks are noted. The maximum width between the side hoofs is measured on the soil surface.

In their final analysis of the census results Flynn & Abdullah (1983) calculated for each set of measurements a 95% confidence interval around the median (not the mean), and a multiple analysis of variance was employed to compare the samples and to decide which pairs were made by different animals. Further tracks of the same size and age, but separated by more than 8 km in distance, were also considered different individuals. This yielded a minimum count of the rhinos occupying the study area.

Flynn & Abdullah (1983) assumed that their census method detected all rhinos within 2 km of the census routes, thus covering 75% of the total study area. Each census between 6 and 8 rhinos could be identified, and it was concluded that 10 rhinos normally occurred in the study area of 400 sq km, i.e. there was a rhino density of 2.5 rhino per 100 sq km. The density in the area around their study area appeared to be two or three times lower or about 1 rhino per 100 sq km. They estimated a total of 20 to 25 rhinos for the 1600 sq km of suitable habitat remaining in the Endau-Rompin area.

The densities calculated by Horner (1979) for the whole of Gunung Leuser (2-4 per 100 sq km) and those from Flynn & Abdullah (1983) for Endau-Rompin (2.5 per 100 sq km) are considerably lower than the density calculated in this study for the upper Mamas in Gunung Leuser (13-14 per 100 sq km). However Horner's figure of 16 rhinos living in his main study area, which partly covers the upper Mamas, compares well with the results of the present study, but his total estimate for the whole Gunung Leuser population, implying a density of 2 to 4 rhinos per 100 sq km, seems to be inconsistent with the results from his main study area.

The low densities calculated by Flynn and Abdullah (1983) are surprising because the Endau-Rompin area seems in many aspects to be comparable with Gunung Leuser. Both rhino areas are large and mountainous, with a similar climate and vegetation and both are relatively undisturbed by recent poaching. There seems to be no good reason for a rhino density four or five times higher in Gunung Leuser than it is in Endau-Rompin. In the past few years the author made two short trips to a part of the Endau-Rompin area (Upper Selai in 1977 and 1982) and during both trips numerous signs of rhino were encountered. The trail system and the wallows are certainly less well developed than in Gunung Leuser, but otherwise there were no apparent differences in the frequency of tracks and other signs of rhino. From my admittedly short visits to the area and the number of rhino tracks found, I believe that the difference in calculated densities for the two areas is due to different census methods rather than to real differences in rhino density.

Even with the most accurate measurements of a long series of prints, only some of the rhinos can be separated on the print width alone. Moreover the assumption of Flynn & Abdullah (1983) that the census detects all rhinos within 2 km from the census routes, is probably too optimistic, and therefore in the following calculations a distance of 1 kilometre has been used instead. The maximum distance of 8 km between tracks of the same rhino seems appropriate and implies a maximum range of about 50 sq km, a figure supported by the results of this study (see chapter 5.2). Tracks of the same rhino were rarely encountered more than 8 km apart.

To assess the usefulness of different census methods for estimating populations of Sumatran rhino, the data collected in the Mamas were analysed again using, as much as possible, the methods of Flynn & Abdullah (1983). This mimics a census in an area with a known minimum density. Each expedition was treated as a separate rhino census. For each track the average width was calculated using all the measurements available, both those taken in the field and those taken from the casts.

All the tracks, with their average widths, were plotted on maps, each expedition being considered separately. Tracks that were considered to be made by the same individual (less than about 10 mm difference in width, less than 8 km apart) were connected by lines, starting from obvious concentrations of similar-sized tracks. The number of individuals that could be detected in this way are summarised in table X below, together with the number of individuals that could be recognised from the casts (See also figure 3.28 - The uncertain records, shown by open circles in this figure, are also counted, because these casts were certainly from different if unidentified rhinos.

The area censused during the expedition was calculated using both the transect width of 2 km on either side of the patrol route, recommended by Flynn and Abdullah, and a transect width of 1 km on either side (see above). These calculations were made only for those expeditions, when most of the study area was patrolled. The calculated areas are shown in table X. Four examples of the maps made for each expedition are shown in figure 10.1 and 10.2.

The number of individuals determined from the print width analysis is in most cases lower than the number that could be recognised from the plastercasts, and it is never more than 10-12 individuals. Print width varies little between individuals (18 to 23 cm), and at most only 5 adult size classes can be recognized, each differing by 1 cm. In a study area 20 km long and 10 km wide only two individuals from each size class can be recognized and only if they are 6 km apart. More individuals can only be separated when there are juveniles. This limitation of the print width analysis was also recognized by Flynn & Abdullah (1983).

Table X: Comparison of track counts using print width and plastercast analysis (data from this study).

Expedition no	Number of rhinos present				Size of the area (sq km)	
	Print width analysis		Plastercast analysis		Strip width on either side of route	
	adults	juveniles	adults	juveniles	2 km	1 km
(2)	4	-	4	-		
(3)	3-4	-	3	-		
4	7-8	-	9	-	227	126
(5)	3-4	-	2	-		
6	10-12	2	13	2	278	156
(7)	8-9	1	4	1		
8	9-10	2-3	9	2	276	164
9	8-10	2-3	10	2	268	154
10	9	4	12	4	245	135
11	8-9	2	15	3	280	153
13	7	-	17	-	224	128
14	9-11	2	19	2	273	156
16	10	1	19	1	277	162
17	7-8	-	15	-	216	123
Average from 14 expeditions	8-10		13-14		256.4	145.6

Great differences were found in rhino ranges when identifications based on print width were compared with those based on the plastercast analysis. Of all the 'individuals' shown in the maps in the figures 10.1 and 10.2, only one was confirmed by the plastercast analysis. In all other 'individuals' there was at least one track that was misassigned and many groups were composed of tracks from three, four or even five different rhinos. Therefore the simple print width analysis is not suitable for anything more than counting numbers, and only with a few widely separated tracks. This method may be useful in areas with a very low density of rhinos, or when few tracks can be found because of bad weather. In periods of extremely heavy rainfall (like expeditions 5 and 7) measurements seem to be more useful than casts (see table X), since casts can seldom be made in periods of heavy rain. As more tracks are found results from the print width analysis underestimate the true population density.

For all the successful expeditions four population densities were calculated using both methods of counting and both calculations for the size of the area (For the print width analysis the median values were used). The results are shown graphically in figure 10.3. The densities based on the print width analysis do not differ much between expeditions, but as has been explained above these values are about the maximum number obtainable from this method. For the earlier expeditions figures from the two methods of counting are rather similar.

In the later expeditions estimates from the plastercast analysis are much higher and in fact rather close to the values calculated from the spatial distribution (see chapter 5.3.1), if a strip of 1 km on either side of the patrol routes is used to calculate the area of the census. The apparent difference in effectiveness of the plastercast analysis between the earlier and the later expeditions must be attributed to the researcher's increased experience. During the second half of the study it was realised that old tracks, with proper treatment, could also produce useable plastercasts, and a much larger number of the tracks found could be identified. To compare the effectiveness of the two methods it is best to consider only the results from the later expeditions, when it is clear that the plastercast analysis gave by far the most realistic results. The average rhino density for the expeditions 10 to 17 is 11.3, compared to 12.9 and 14.4 calculated from the animal's spatial distribution.

The estimate of rhino density obviously varies with the estimated size of the area censused. It seems that in fact the survey teams are not covering a transect width of 2 km on both sides of the trails and that a width of 1 km on either side is much more realistic. One could reduce the strip width to 300 metres to bring the values obtained with the track count more in line to those obtained from the spatial distribution. But since 1 km on either side is a convenient distance to work with and gives conservative estimates, this strip width is recommended for future use. For total population estimates plastercast analysis of prints is a more useful method than measuring print widths.

In the Endau-Rompin area Flynn and Abdullah conducted four censuses. Once they calculated a density of 2 rhinos and three times 2.5 rhinos per 100 sq km. All values calculated for the Mamas using Flynn and Abdullah's methods are higher, which would mean that in Gunung Leuser the rhino density is indeed higher than in Endau-Rompin. How much higher is difficult to

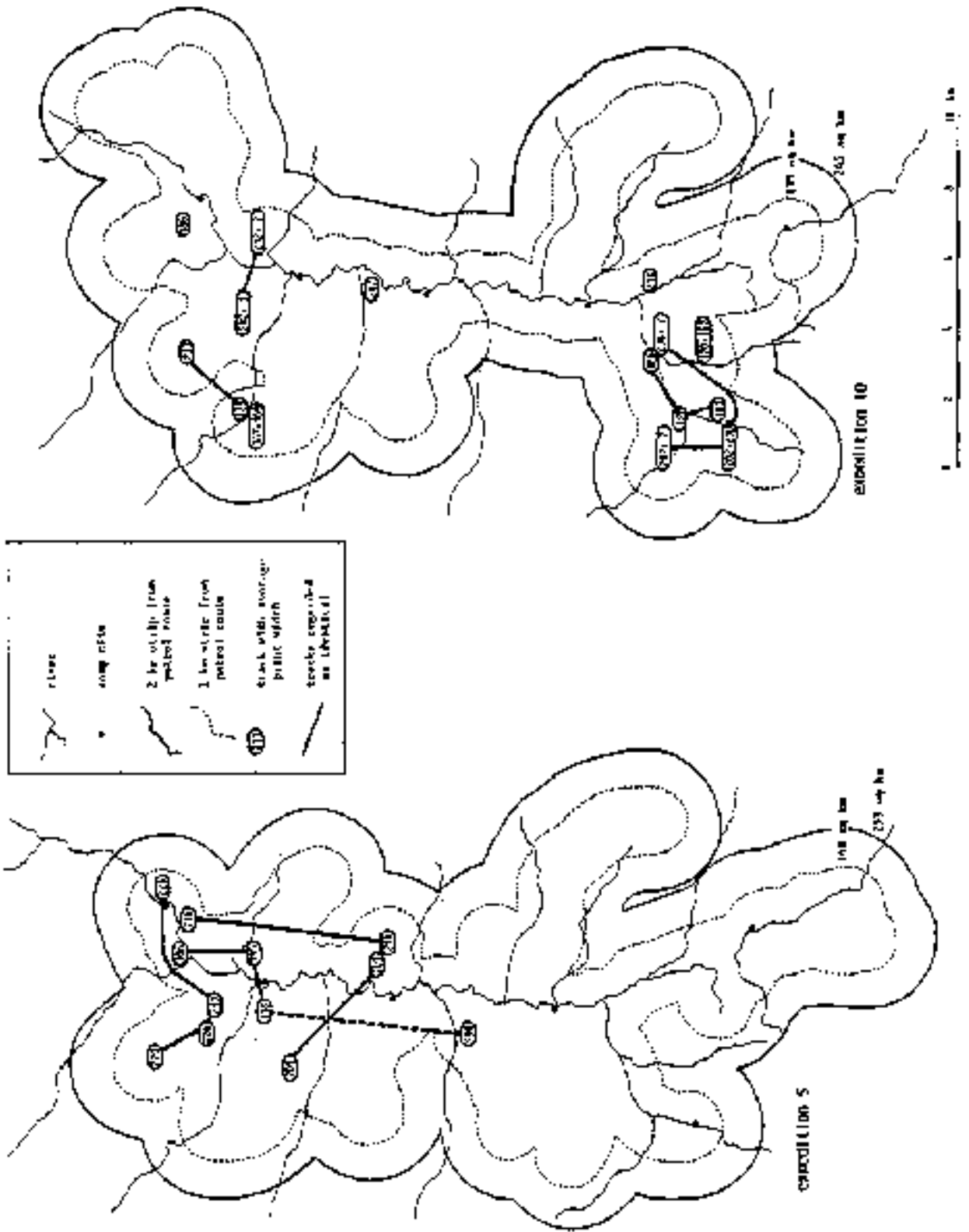

Figure 10.1 and 10.2 - Four examples of the distribution maps used to estimate the number of rhinos observed, using print width only to 'identify' individual rhinos.

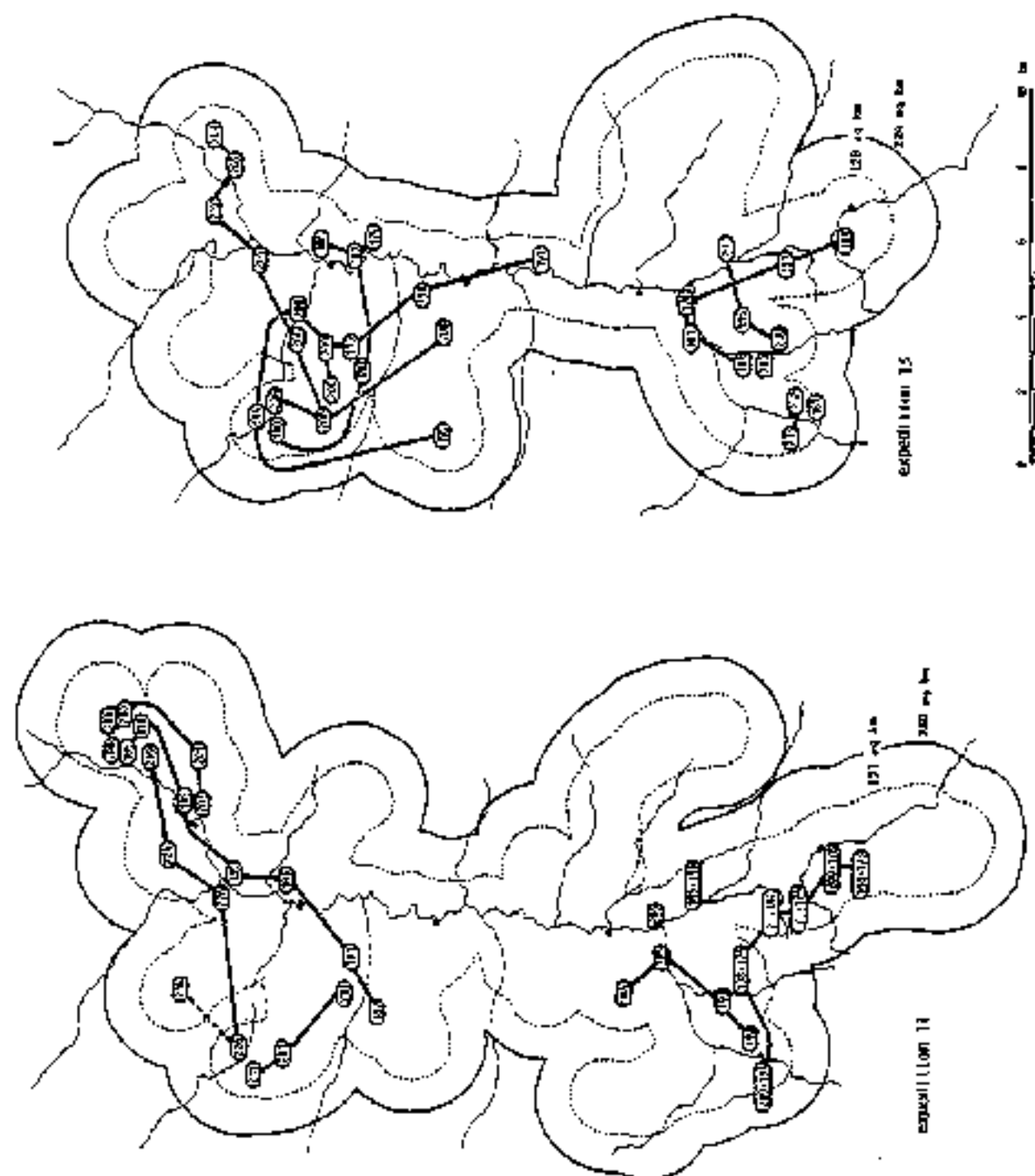

Figure 10.7

say from these figures, because the density of 3.5 rhinos per 100 sq km is about the maximum possible from the method, but it would be highly unlikely that the density in Gunung Leuser is indeed four to five times as high as it is in Endau-Rompin. More probably the density in Endau-Rompin has been underestimated and the total number of rhinos is higher than the 20 to 25 estimated by Flynn & Abdullah (1983).

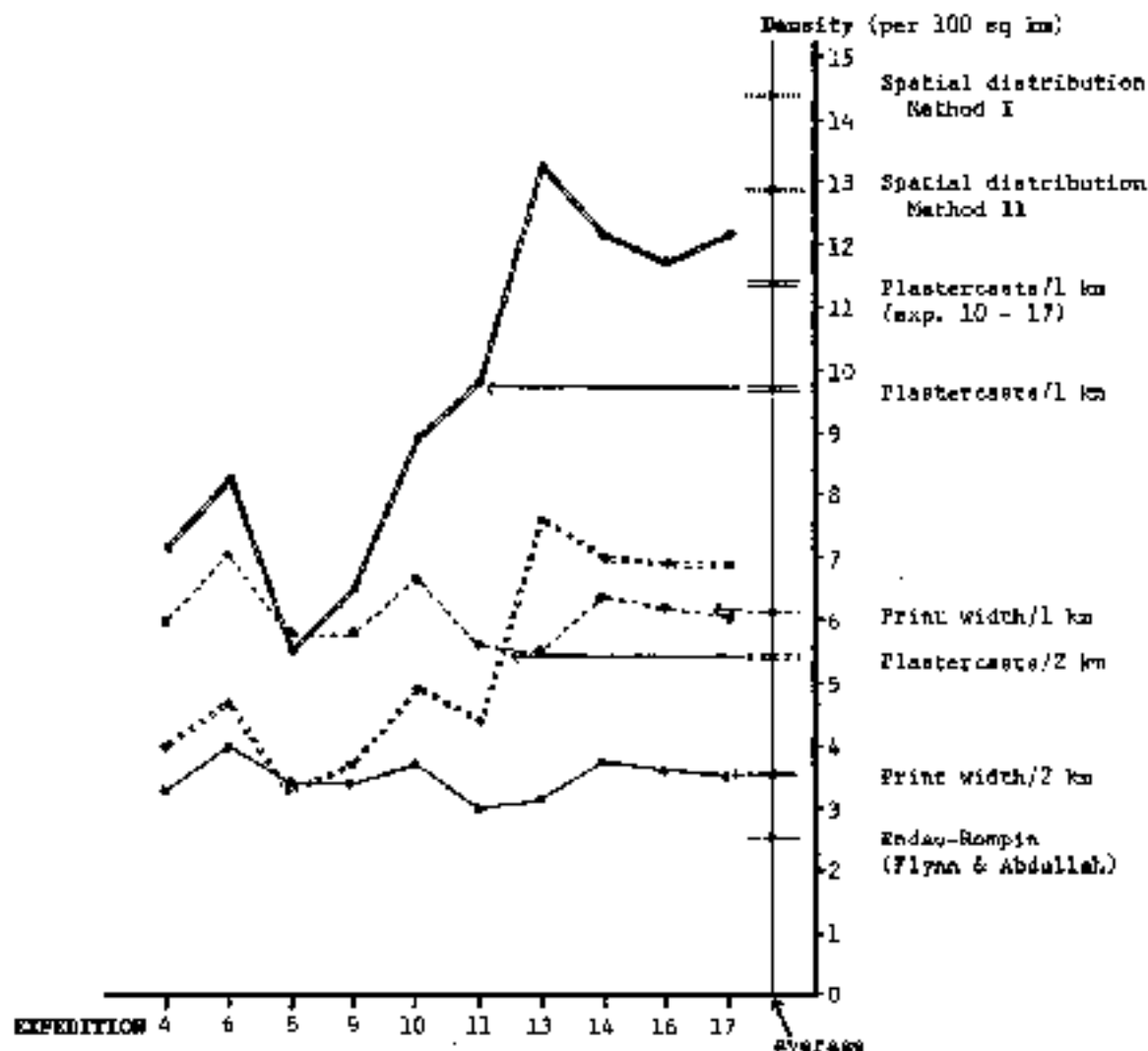

Figure 10.3 - Population density of the Sumatran rhino in the study area calculated from the number of different tracks per expedition. Both print width and plastercast analysis were used and the size of the area was calculated using a 1 km and a 2 km strip on either side of the patrol route. The average figures are compared with the density calculated from the known spatial distribution of animals (method I and II) and with results reported for the Endau-Rompin area (Flynn & Abdullah, 1983)

10.2 - Usefulness of different measurements for assessing rhino populations

Although the techniques based on print width measurements may not distinguish between all rhinos this method had some advantages over the use of plastercasts. Measurements can be made quickly of a large series and evaluation of the results requires little skill or patience; this technique can be mastered with little special training. For future studies and for better management of the remaining rhino areas a simple but reliable technique for census of rhino will be very beneficial.

In this study five standard measurements, described in chapter 3.3.3, were taken during the process of sorting. For identifying plastercasts the standard measurements were not used, because they show considerable individual variation. These measurements (or combination of measurements) were assessed for usefulness in distinguishing between tracks made by different rhino, as an alternative to using plastercasts. All measurements from one rhino were regarded as one sample and we may expect that this sample will show a similar amount of variation as a series of measurements taken from one track in the field.

To illustrate the variation found in the standard measurements of one rhino, the distributions of the measurements in one set (set 49, undoubtedly made by one rhino) and the distribu-

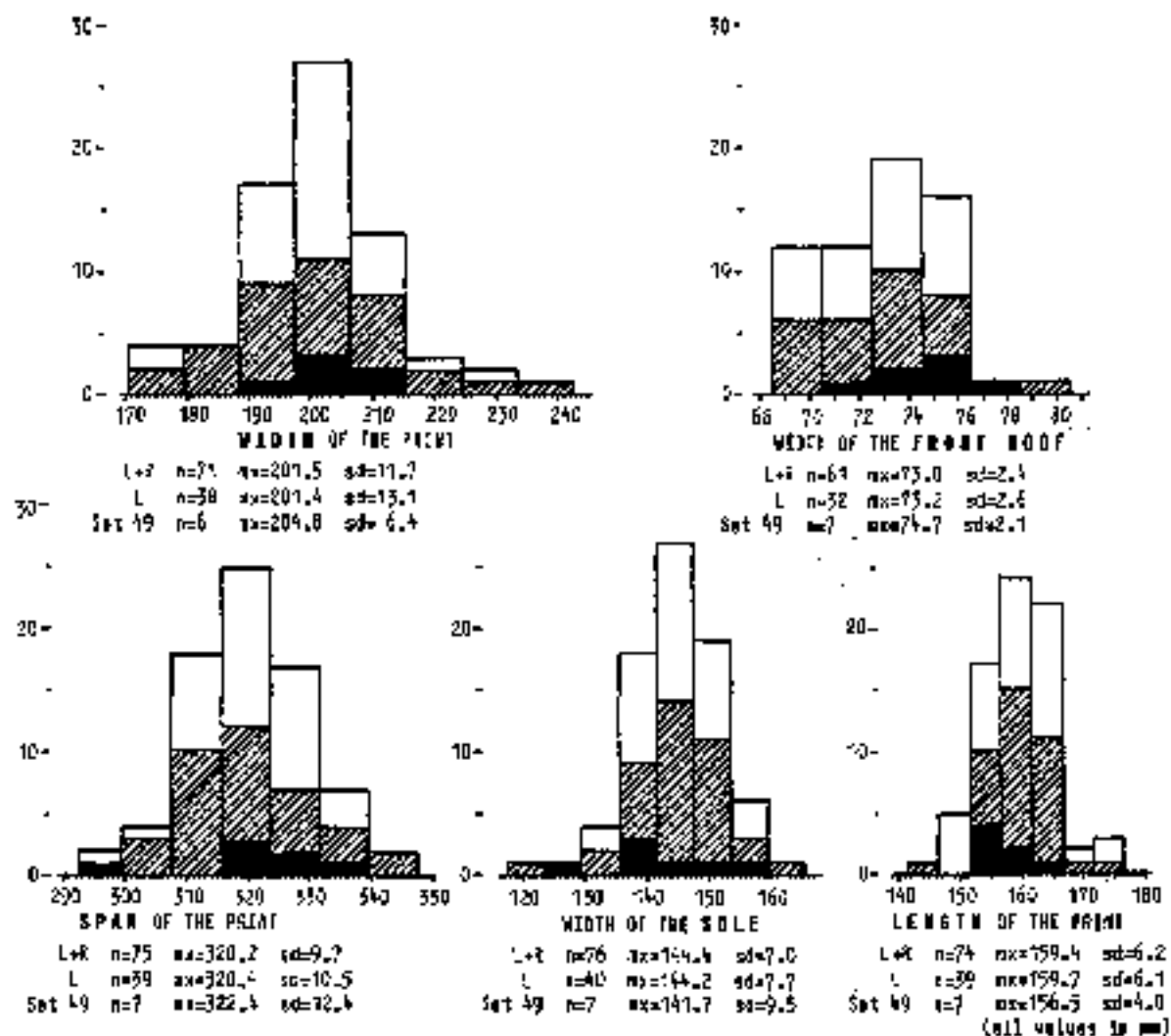

Figure 10.4 - Variability in the five standard measurements taken from the model series 520. The black area represents the values found in set 49 (casts undoubtedly made by the same rhino). The shaded area represents the values taken from the left foot casts, the white area the values from all casts. For the definition of the standard measurements see chapter 3.3.3 and figures 3.6 and 3.7

tion in one of the best series (series 520, including also set 49) are shown in figure 10.4. The black area shows the distribution of the measurements in set 49, the shaded part of the figure shows the distribution of the left foot measurements, the white area the distribution of the values for both feet together. The distribution of the left foot values is similar to the distribution for both feet together and also the means are very close. In all measurements there is a considerable amount of variability, especially in the values for the width of the print. It will be clear that a single measurement is virtually useless for distinguishing of individual's tracks, and that only means from larger samples can be used. The irregular distribution of the width of the front hoof is due to varying soil conditions, that cause biasing towards the lower values (see chapter 3.5.2).

For these measurements no distinction was made between left and right foot prints. Left and right foot are not mirror images of each other but the differences found were mainly of form and position and not of size (see also figure 10.4). Only in the rare cases of extremely long side hoofs (see chapter 3.5.4) were there slight differences in size.

The measurements considered here are taken from the plastercasts and not from tracks in the field. As many casts were broken during transport there could be slight deviations in the position of some hoofs in the mounted cast. There are also different ways to measure the width of the print, the most frequently used measurement. In this study the distance between the tips

of the side hoofs was measured, both on the plastercasts and in the field, with a pair of callipers, but others studies have measured the maximum diameter with a ruler on the soil surface, which may cause slight differences in the values obtained.

To find out which of the 5 standard measurements or which combination of measurements is best for distinguishing between different samples an analysis of variance was made for all the standard measurements from 36 series (one 'young' and two single-cast series were excluded). The differences between the means were tested for significance at the 5% level, using the method of Newman and Keuls (de Jonge, 1964). This is an analysis of variance for more than two samples of different sizes, in which the number of intermediate means is taken into account.

The width of the print and the width of the sole were the least useful measurements for distinguishing between individual rhinos. Significant differences were found in less than one-third of the compared means. Only when measurements from a sample of a very large rhino were compared with those of a very small animal was the difference significant, in about 20 intermediate samples there was no significant difference. The span of the print and the length of the print proved to be more useful measurements, with about half of the compared means differing significantly. By far the best results were obtained with the width of the front hoof. For this value almost 78% of the compared means differed significantly, with only about 5 intermediate samples not significantly different.

With the exception of the width of the front hoof the use of only one measurement is of limited value for distinguishing between tracks. To find out which combination of measurements was most useful for identifying individual rhinos the combined results of all five analyses (in figure 10.5) were studied further. Of all the 630 possible comparisons between series 90% differed significantly in at least one of the standard measurements. But from all 176 compared pairs which differed only in one standard measurement, more than 78% differ in the width of the front hoof. The span and the length of the print each contribute only about 3% of the sample's significance; in fact these measurements can easily be omitted, as they are of little help in distinguishing between individual prints.

The width of the front hoof is the most useful diagnostic character, but this measurement can only be taken from a plastercast. If it is not possible to take plaster and to make plastercasts the front hoof width cannot be measured. From the four other measurements only 68% of the compared pairs show a significant difference; this is less than the number that can be distinguished using the front hoof width alone. The next most useful measurement is the span of the print, but the width of the print is the least important value. The best results are obtained by measuring the print span (including the sole) and the length of the print. However the diagnostic value of each of these measurements is so low that it is debatable whether it is worth the trouble to take more than the simplest of measurements, i.e. the width of the print, and then only when casts cannot be made. Additional measurements will only marginally increase the number of individuals whose tracks can be separated. It is probably not even worth the time and energy spent on the field trip.

If casts of front hoofs can be made quite satisfactory results can be expected. The most useful combination of measurements is a combination of the width of the front hoof, together with the width of the print and the length of the print. In 87.9% of the compared pairs of the 36 series one or more of these three showed a significant difference. With this combination of measurements one can separate most of the individual rhino's tracks. With further evidence from morphological features shown by the front hoof casts, the results might be almost as good as with complete plastercasts. It is much easier to find some good prints of front hoofs than it is to find good complete prints and one needs only a small amount of plaster to cast the hoofs.

Results are much more meaningful if the sample includes measurements from 10 or more prints. Best results are obtained with measurements from at least 20 prints in a track. For front hoof measurements one should aim, for practical reasons, at 5 casts each from both the left and right feet.

With about 20 measurements of the width and the length of the print and about 10 casts of front hoofs of every track encountered, most individual rhinos can be recognized easily. A few weeks in the field and about one kilogram of plaster per day is usually sufficient for adequate results. As can be seen in the figures 3.5 and 10.3 experience is an important factor in this sort of work, and one should expect suboptimal results during the first few censuses.

There were considerable differences in numbers of rhinos found on different expeditions, so if only one census is performed in an area one should expect a rather wide margin of error. The variability of the weather is probably the most important factor influencing the results. Failure to identify all the tracks and migration of rhinos in or out of the area will also affect the results. In very dry conditions one may miss tracks in the field. Under normal conditions one will only find tracks of a few days old, but one can assume that most of the rhinos responsible are still in the study area. During periods of prolonged dry weather tracks remain for a much longer period of time, and the animals responsible may have left the study area. In dry weather conditions one may count too many animals, in very wet conditions too few, as some will be missed.

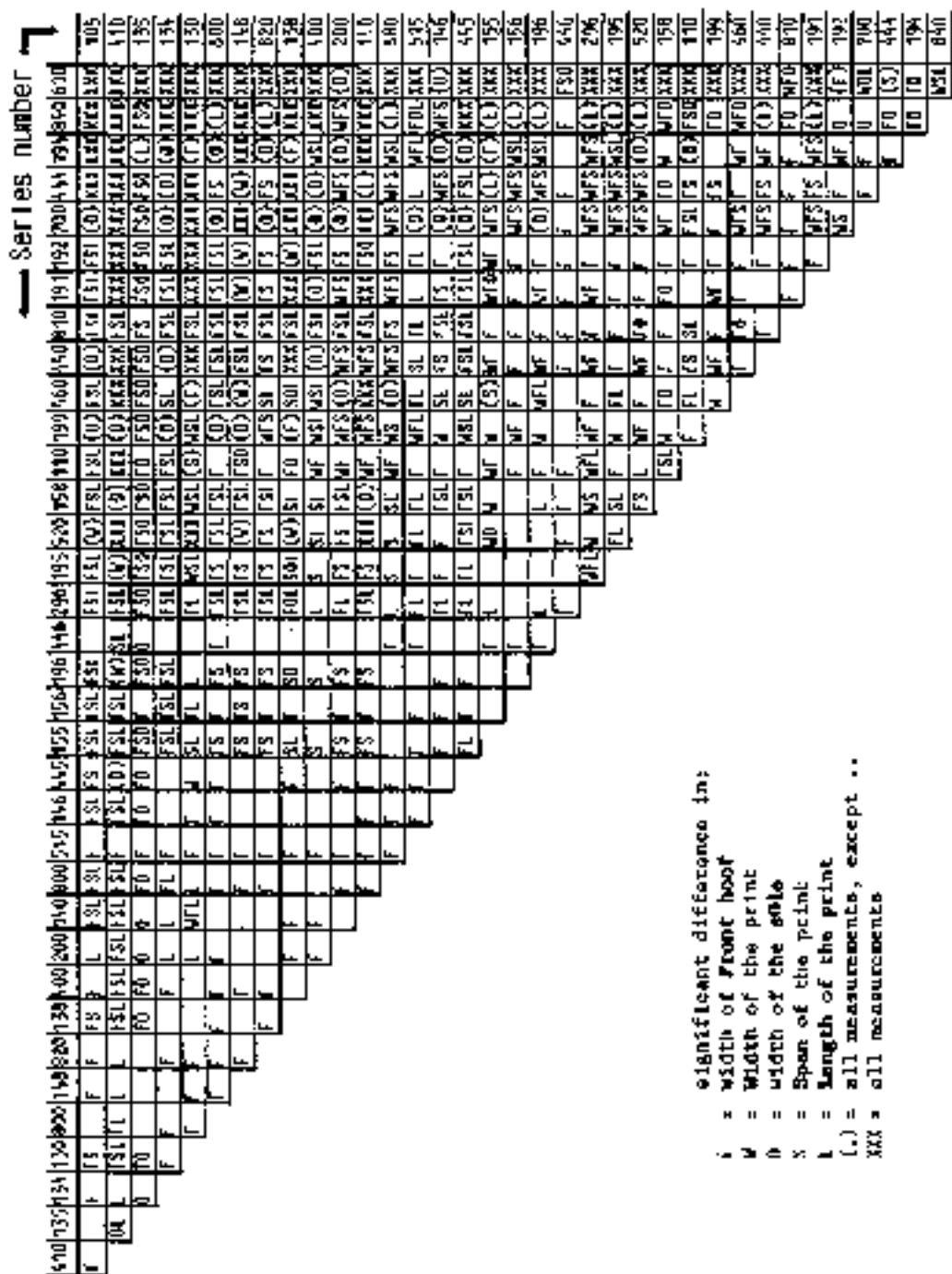

Figure 10.5 - The results of the analysis of variance of all five standard measurements between the different series. The figure shows each pair of series in which significant differences were found between standard measurements

10.3 - Track counts for estimating rhino density

The number of tracks of a species found in a certain area must be related to the number of animals living in that area. Under certain conditions the number of tracks are proportional to the density of the species. By comparison of track count results with those for an area where density of animals is known the density in the survey area can be calculated. For Sumatran rhino tracks counts from other areas can be compared with the upper Mamas.

By relating the number of fresh tracks to the kilometre hour (km.h) score (see chapter 5.4.1), the effects of the weather and the intensity of the patrolling can be eliminated. Fresh track counts from different areas or taken on different occasions can be compared. The number of fresh tracks found in relation to the km.h score is presumed to be constant in an area with a certain density of rhinos.

For all expeditions the total km.h score (the sum of the km.h scores for each section patrolled) was calculated and the number of fresh tracks were counted. In this case the tracks were not counted per section but over the whole study area. All tracks found close together and believed made by the same rhino were counted as one animal, as were tracks that followed the same route up and down again. The number of fresh tracks per 10 000 km.h for each expedition is shown in figure 10.6. The expeditions are arranged according to the km.h score, because with an increased score the deviation from the mean is expected to be less.

The km.h scores range from 3000.98 (expedition 3) to 18 108.71 (expedition 14). The variation can be attributed to the varying amount of rain during the expeditions. The number of fresh tracks per 10 000 km.h shows great variation on the left-hand side of the scale, but for the more successful expeditions with high km.h scores the values are much closer to the average. Fresh track counts made during trips with a km.h score of less than 10 000 appear to be useless, because the results are too variable to make a correlation with density.

The total km.h score for all expeditions together is 137 837.18, with 127 fresh tracks, or 9.2 fresh tracks per 10 000 km.h. The average for all the expeditions shown in figure 10.6 is 9.7 with a standard deviation of 3.4. If only the expeditions with a score of more than 10 000 km.h are considered the average is 8.4, with a standard deviation of 1.8. In the upper Mamas

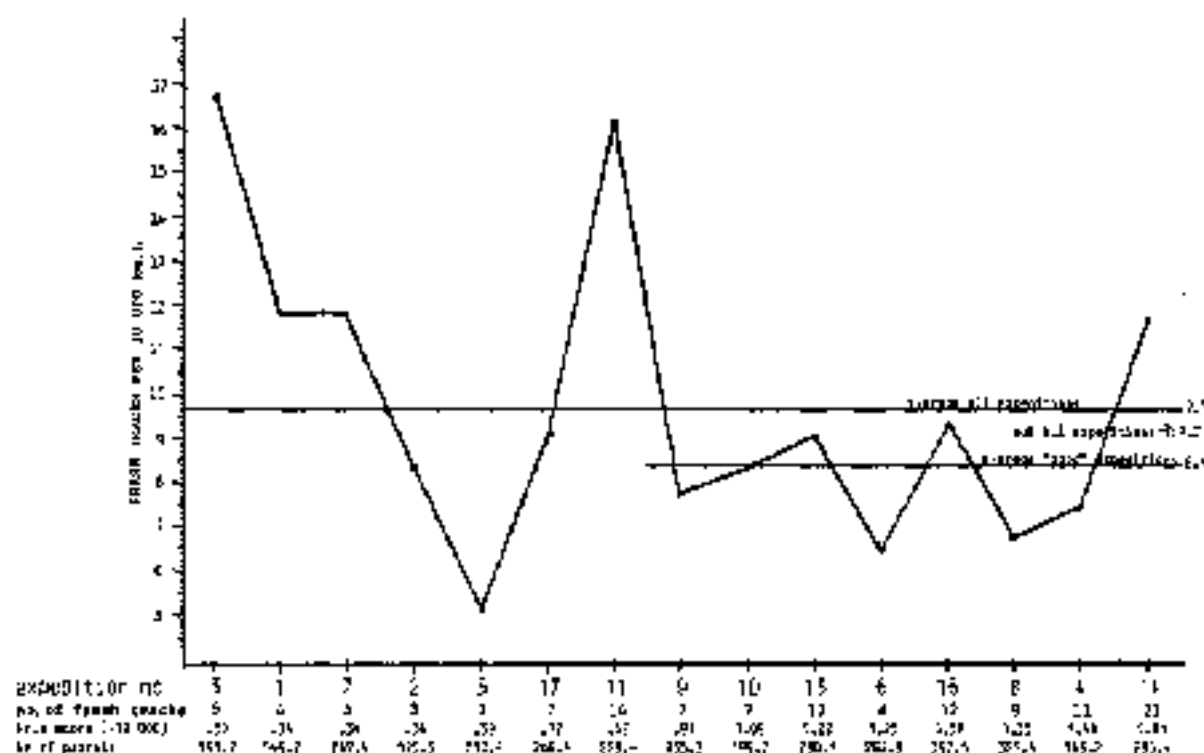

Figure 10.6 - The relationship between the number of fresh tracks found and the "patrolling activity" expressed as the kilometre hour score per expedition. This demonstrates the correlation between the fresh track count and the density of the rhino

the density of rhinos was calculated as about 14 per 100 sq km (see chapter 3.3.1), and on average about 9 fresh tracks are found every 10 000 km.h of patrolling. So one may calculate the density of the rhino in number per 100 sq km as the 14/9 of the number of fresh tracks per 10 000 km.h of patrolling.

Because good results are only possible if one is able to survey more than 10 000 km.h in a certain area - in practice this takes at least three weeks in the field and at least 300 km of patrolling - this method is only recommended to support a rhino census using track identification, or for those making an incidental rhino census during long periods in the field engaged in other research. The procedure for a fresh track count will be described in detail in a separate paper (in press).

10.4 - Censussing rhino

In previous chapters it has been demonstrated that it is possible to make reasonably reliable estimates of numbers and density of Sumatran rhinos using relatively simple census techniques. The use of print width measurements alone is insufficient, and should only be used in areas with a very low density of rhino. Counting fresh tracks can be a useful procedure under certain conditions, but by far the best results are obtained when tracks are identified with the help of plastercasts of front hoofs and sets of two measurements from the prints. The use of plastercasts is essential for a good census, and if casts are made of front hoofs only the researcher needs to carry only small quantities of plaster and finished casts.

Detailed procedures for a census of Sumatran rhino are described in a separate paper (to be published as an instruction manual for those involved in field surveys for the drafting of an international conservation masterplan for the Sumatran rhino, currently undertaken by IUCN). Here only a short description is given.

A fresh track count is most useful if the researcher can spend a relatively long time in the area and can cover a large distance. Under normal conditions in Southeast Asia one must spend at least three weeks in the field and cover at least 300 km of patrol routes, to attain a km.h score of 10 000. It is also possible to accumulate the results from several shorter trips in the same area and this census method could be used successfully by field personnel in conservation areas, who usually spend a considerable amount of time on patrols. On rhino surveys a fresh track count should always be accompanied by track identification.

It is essential to distinguish between fresh (not affected by rain) and old tracks. The patrol route must be carefully mapped on a good large-scale map and is later divided in convenient sections, $\frac{1}{2}$ to $1\frac{1}{2}$ km long. The length of each section must be measured on the route map. Daily records must be kept of rainfall and for each section of the patrol route the approximate number of hours between the end of the last rain and the time of the patrol is calculated. This is multiplied with the length of the section in km and the sum of the products is the km.h score for the survey. The number of clearly distinct fresh tracks is counted and the density of the rhino in the area (number per 100 sq km) is estimated as 14/9 of the the number of fresh tracks (number per 10 000 km.h).

For track identification one can use fresh tracks and also older tracks that have been little blurred by rain. For each track encountered the width and length of a series of prints is measured, using a pair of callipers. The width of the print is measured between the tips of the side hoofs and the length is measured in two stages, from the middle of the line through the anterior edges of the side hoofs to the centre of the fold between the front hoof and sole, and from the last point to the tip of the front hoof (see figure 3.6). At least 20 good prints in fairly firm soil should be measured, preferably on level ground. The width of the sole and the span can also be measured, but these measurements are of little help in distinguishing individuals.

To measure the width of the front hoof one should make a number of casts of good clear prints of front hoofs, carefully cleaned before casting. Five casts of left and five of right foot prints will usually suffice. No more than about 1 kilogram of plaster will be needed for each track. If there is more plaster one can make a few casts of complete prints. The width of the front hoof is measured with a calliper rule (see the examples in figure 3.7). A few of the best plastercasts should be preserved for comparison of the morphological characteristics.

The samples of measurements are tested for significant differences with an appropriate statistical technique (multiple analysis of variance - A simplified method without statistical calculations is described in a separate paper on the census procedures). By combining the groups of samples that show significant differences in the different measurements, the minimum number of rhinos in the study area can be estimated. Tracks found on the same survey but 8 km or more apart are ascribed to different rhinos. The system can be further refined by comparing specimen casts and checking other data, such as dates and directions of movement, for records to support or refute the identification.

The size of the census area is calculated from a map, by drawing a 1 kilometre wide zone around the patrol routes and the density of rhinos is calculated. A suitable study area for Sumatran rhino should be 100 to 200 sq km, covered as completely as possible by patrol routes. The routes should be evenly spaced, about 2 to 4 km apart and with a total length of 75 km or more.

It is difficult to determine the optimum length for a census; it depends very much on the prevailing weather conditions and terrain. Ideally measurements should be gathered from at least 20 to 30 clearly distinct tracks. Under favourable weather conditions this may take 2 to 4 weeks in the field, every day covering 7 or more km of the patrol routes. In periods of heavy daily rainfall it will take much longer and periods of heavy rain should be avoided for a rhino census. The duration of the census can be shortened if more than one team operates simultaneously in the area.

It will be clear that any serious census will require a considerable effort. Apart from the difficulties in penetrating the remote areas where most rhinos are found these days, the researcher will have to spend many days in the rhino area and walk long distances, usually in difficult mountainous terrain. Although the technique is simple, it can only be mastered properly through experience, and one should not expect good results in the first few trials.

10.5 - Recommendations for further ecological study

In this study emphasis was placed on patrolling a large area to collect information on rhino distribution and individual ranges. This left little time for following single tracks and studying other aspects of the rhino's life. Only limited cursory information was obtained on the rhino's daily activity, social system and feeding behaviour. The remoteness of the study area and the difficult access meant that only a relatively small part of the researcher's time could be spent inside the rhino's habitat, which limited the possibilities for more detailed observations on specific tracks and situations.

This study has proved that it is possible to investigate many aspects of the rhino's life without ever coming close to the animal. From careful study of their tracks a great deal can be learned about the activities of individual rhinos. Apart from details of the animal's spatial and temporal distribution, on which this study concentrated, studying tracks gives information of feeding and foodplant choice, daily movements, daily rhythm, social systems and reproduction. Following individual tracks, and more concentrated patrolling of a smaller area will yield more information on these aspects of rhino ecology than was possible in this study.

The Sumatran rhino is the largest herbivore that lives exclusively in the tropical rainforest, a habitat characterized by the constancy of environmental conditions. Only a few species of larger herbivores (tapir, sambar, muntjak, serow and wild pig) share this habitat with the rhino, and in general very little is known about the ecology of these animals, because of the difficulties of observing ground-living animals in the tropical forest. Further study of the rhino's ecology will not only add to our knowledge of this species' biology, but will also give a better understanding of the living conditions on the forest floor. Most zoological research in rainforest to date has concentrated on the ecology of canopy-living animals.

The results of this study form a sound basis for further research on the rhino's ecology in the upper Mamas, if the problems of access to the area can be solved. More detailed studies are only feasible if a permanent base camp can be established in the area and substantial funds allocated for regular helicopter transport of personnel and goods to the area.

Continued research in the upper Mamas is not only recommended from a scientific point of view, but is also urgently needed to protect one of the last viable populations of the Sumatran rhino. The existing management structure of the Gunung Leuser National Park cannot give the rhino adequate protection against poaching. Although there is a special task force for the protection of the rhinos, the rhino area has not been patrolled regularly since the end of this study (1981), and probably rhino poachers have started trapping there again. Since regular surveys of the area are beyond the scope of the park management at present, a research programme based permanently in the upper Mamas, would help prevent the total extermination of the rhino in Gunung Leuser.

CHAPTER 11 - CONSERVATION OF THE SUMATRAN RHINO

11.1 - The chances for survival

The present situation for the Sumatran rhino has been discussed in detail in appendix B. Although this study suggests that there are probably considerably more Sumatran rhinos left than previously believed (see van Strien, 1974), this does not mean that their chances for survival should be rated highly. While there is no immediate reason to worry about the viability of some of the remaining populations, few are safe from poachers or from loss of habitat. More rhino populations are now included within reserve boundaries, but few of these reserves afford more than token protection. In all the countries throughout its distribution the rhino has complete legal protection, but such legislation is rarely enforced. Moreover many reserves are understaffed and under-equipped and most are under threat from developments that violate the integrity of the reserve.

Threats vary from area to area and since the situation can change rapidly with new political, economic and military developments rhino populations are nowhere really safe. At present the rhino population in the Taman Negara in west Malaysia is probably most secure. The park is legally well established, it has a good management structure and active guardforce and its integrity has so far been preserved against pressure from development sides. Unfortunately the number of rhinos surviving is probably rather low (see appendix B).

The Endau-Rompin area, harbours the largest Malaysian population, which seems relatively safe. This area has only recently been declared a reserve. There seems to be very little hunting pressure in this region and there is probably a good chance to establish a worthwhile reserve there.

Probably the only rhinos left in Borneo, those in southeast Sabah, are seriously threatened by hunting. Part of their habitat is now protected in the Tabin wildlife reserve, but many rhinos remain outside the reserve area. In several areas there is much pressure on their habitat from the human population for agricultural developments, and the logging operations make most areas accessible to hunters.

By far the largest populations of Sumatran rhino are left on the island of Sumatra, mostly in established reserves. The Gunung Leuser National Park (in fact a conglomerate of 7 adjoining wildlife reserves) has good legal protection and the mountainous topography protects the rhino's habitat. Unfortunately the park guardforce is still inadequate, more from the point of quality than quantity, and there are no means to prevent hunters from entering the park. Unless appropriate measures are taken soon (see chapter 10.5) it is feared that rhino hunting may begin again in the study area now that the research team has left the upper Mamas.

Probably the largest surviving population of Sumatran rhinos occurs in the Kerinci-Seblat area. The area was declared a National Park in 1982, but in fact it is a mosaic of game-, nature-, hunting- and forest reserves. The term 'national park' has no legal meaning in Indonesia and the foresters strongly oppose reserving such a large expanse of land. Management structures for the Kerinci-Seblat park are virtually non-existent. The rhinos are probably fairly well protected by the topography and remoteness of the area and there seems to be little interest in rhino hunting in this part of Sumatra, but the area is under heavy pressure from logging, agriculture and resettlement schemes. There is still time to create an effective protection and management structure for the park, but it is very uncertain whether this will be achieved before the area will be fragmented by further forest clearance.

The Barisan Selatan reserve in southern Sumatra suffers from the same problems. The legal status is fairly clear, but the park management is ineffective and there is heavy pressure from the overpopulated surrounding areas. The reserve is long and narrow and will be fragmented soon.

Elsewhere only the Phu Khio reserve in Thailand seems to warrant special attention. There may be more than a few rhinos left there at present, but information is inadequate. The same is true for the rhino's status in Burma, Thailand, Laos, Vietnam and Cambodia. Viable populations of rhinos may survive in these countries, but a thorough survey is necessary to determine population numbers.

Protection against poaching is important to ensure the short-term survival of the Sumatran rhino, but in the longer term, the size of the population and the size of the available habitat are of prime importance. The smaller the size of the remaining population the less its chances of survival. Smaller populations are much more susceptible to random fluctuations in numbers and have less genetic variability.

In recent years various theories have been developed on the relation between population size and genetic fitness and the relation between the size of the population and its chances for

survival. To minimize the negative effects of inbreeding and genetic drift on the fitness of a population its size should not fall below a certain minimum number. For short-term survival - that is over the next few generations - the minimum number of breeding animals is assumed to be an effective population size of 50. For long-term survival, however a minimum effective size of 500 individuals is recommended (Frankel & Soule, 1981).

Although a breeding population of 500 animals is probably necessary to guarantee the population's long-term fitness and survival, this does not mean that smaller populations can be neglected. Much depends on how long the population has survived at a low level. If the population is low only for a short period and is allowed to grow back to a reasonable size, the damage is limited. Only if populations exist for several generations at a very low level will the erosion of the genetic variability become serious and survival become unlikely. For those populations confined to small remnants of habitat capture and translocation or captive breeding might be a better strategy for survival than remaining *in situ*.

Since the sex ratio is approximately 1:1 and mating is probably random, the effective population size is about equal to the number of fertile adults. The minimum total population (including 40% sub-adults) for immediate fitness and long-term fitness can therefore be estimated at respectively 70 and 700 individuals. None of the existing populations reach the higher value, but the Kerinci-Sablar population may number 250 to 500 individuals. At least two of the Sumatran populations - Leuser and Kerinci - number more than the lower value of 70 individuals.

Therefore at the moment none of the remaining Sumatran populations can be said to be fit for long-term survival, using genetic criteria, but a number are certainly 'safe' for the next few generations, if left in peace. If the average density of the Sumatran rhino is taken as 10 animals per 100 sq km, the area that could hold a population large enough to safeguard long-term survival must be at least 7000 sq km. Leuser and Kerinci are both bigger than this. Taman Negara in west Malaysia covers about 60% of this minimum area, but all the other reserves are considerably smaller. From these calculations it seems that only the rhino populations in Leuser and Kerinci and possibly in Taman Negara are assured of long-term survival, provided that the depleted populations are allowed to recover.

This is encouraging because two of these areas (Leuser and Taman Negara) are relatively 'safe' and the third still has the potential to become a safe refuge. With a few more reserves of this size in Borneo, Thailand and Burma and if possible one more in Malaysia the Sumatran rhino could soon be removed from the list of most threatened mammals. In the future it will become more difficult to set aside continuous areas of this size for conservation, but on Borneo and possibly also in Thailand and Burma this is still feasible.

It is more difficult to evaluate the significance of the smaller areas. No reserve should be created and managed for just one species, but in this discussion only the reserve's value for the Sumatran rhinoceros is taken into consideration. Many of the other areas contain rhinos in numbers far below the required minimum, but several are of such size that they could harbour a moderately large population of 100 to 200 animals, which can be expected to survive for a good many generations. The chances for long-term survival must be rated lower there, but it depends solely on one's views on conservation expectations of future developments, how this affects the plans and decisions made now. If one has a static view of conservation and sees reserves as permanent entities, in which the animals are locked up for ever, there is probably not much point in spending energy and effort in preserving populations that have a less than optimal chance for survival.

If reserves are seen as temporary refuges however, the protection of small populations makes almost as much sense as the preservation of larger ones, in the future it may be possible for the species range to expand, or landscape patterns may be established that allow for coexistence between man and the rhino. In this situation it may be better to have several smaller populations, scattered over the country, from which the rhinos can spread.

It is therefore worthwhile to protect any area larger than 500 to 700 sq km which contains at least 4 to 5 rhinos. Animals from smaller populations in smaller areas not already within reserves might be used for translocation or breeding schemes.

The Sumatran rhino is very sensitive to all forms of disturbance. Whenever a rhino is met in the forest it dashes off immediately after being alerted. An alarmed rhino continues to run for a long way, going straight through the densest and thorniest growth, so it is not unlikely that rhinos will leave areas where they are often disturbed by human presence. They retreat into the forest beyond the limits where fisherman and rattan collectors usually venture and therefore they are normally only found in the remoter parts where man does not often go.

Logging operations will drive away rhinos from the area (Flynn, 1978), but they may return to the area. In Sabah the rhinos returned 3 to 5 years after logging operations had ceased (pers. comm. J. Payne). So rhinos may survive in areas of forest that are logged. If timber-felling is worked in such a way that the rhinos have a chance to retreat before the logging operations, there is a good chance that the rhino will adapt and survive the timber-felling. Logging operations are not the greatest threat to the rhino population, but hunters and settlers invade the area once logging-operations have opened it up.

Production forests adjacent to smaller reserves should be managed in such a way that the rhino, and other large mammals, get a chance to survive there. This would substantially increase the area available to the population without increasing the reserved land area, yet may only require slight adjustments to the cutting schemes and the strict prevention of hunting and legal or illegal settlement in the area.

Most existing populations are seriously depleted by hunting, and in several areas only a few scattered individuals are left, so even with the most rigorous protection it is far from certain that the populations will recover. In some areas the remaining rhinos might be too scattered or otherwise disturbed to reproduce. Even if animals do breed it will take many years before the population will be back to its optimal level. Recruitment is slow, one young in 4 years or more (see chapter 6.4), and it will take 15 or more years for the population to double, so spectacular results cannot be expected in less than half a century.

11.2 - Design and management of rhino reserves

In the previous chapter we discussed the minimum size for a reserve to protect Sumatran rhino. There is of course no maximum, the larger the better and if other animals are also taken into consideration the recommended minimum size of a reserve should probably be even larger. For instance a reserve designed to protect samples of the whole Sumatran mammal fauna, including such wide ranging species as elephant and tiger, should be much larger than the 7000 sq km recommended for the Sumatran rhinoceros alone.

The Sumatran rhino is not nomadic and males and females are fairly evenly distributed over the area, with overlapping ranges. The amount of suitable habitat available seems to be the main factor determining the carrying capacity. Adult males range over 50 sq km or more and make occasional excursions further afield and juveniles also wander over considerable areas, but for the most part the Sumatran rhino remains in a large but well-defined home range. This and the animal's natural shyness mean that crop-raiding by rhinos is not a serious problem and rhino numbers are so low at present that animals need not venture into less suitable habitat.

If a sufficiently large area of suitable habitat can be protected from any disturbance little else has to be done in the form of management to preserve the rhino population. Formerly the Sumatran rhinos ranged from the flat lowlands to the tops of the highest mountains (van Strien, 1974). Today they have almost completely disappeared from the lowlands, and most remaining populations are found in mountainous areas up to about 2000 meters. In Lesser rhinos live between 1200 and 2000 metres altitude and there are no indications that they are occupying sub-optimal habitat. There are still vast areas of these mid-montane forests and they are of little value for agriculture or forestry, at least not at the moment. Rhinos are less affected than other mammals by the loss of the lowlands, as is happening in most reserves through legal and illegal human settlements.

The habitat suitable for a Sumatran rhino can be defined as closed evergreen forest. Rhinos clearly avoid open places and find their food in the undergrowth and understory in the forest or in patches of dense shrub on landslides, treefalls and along river banks. Almost all surviving rhinos are found in areas of primary forest, but that is probably because of disturbance and hunting in areas where the forest has been cleared by man, than because of a strict preference for this forest type. Old secondary forest may be suitable for Sumatran rhinos, if they are not disturbed there.

In any rhino area human disturbance should be as little as possible. In reserves all activities other than patrols and surveys needed to protect the rhino (and the area) should be banned. In non-sanctuary areas where the rhino must live with some form of human landuse, the form and duration of the human activities should be carefully planned and guided.

If timber extraction is taking place in a rhino area, operations should be carried out in such a way that rhinos will not be driven out permanently. Most importantly the disturbance should be confined to as small an area as possible and for a limited duration. Small blocks of forest should be worked in a tight schedule, so that surveying, opening and finishing of the work follows quickly, and the duration of logging activities can be kept to a minimum. Activity centres should be at least 10 to 15 km apart, so that animals can seek refuge in undisturbed forest between. Strip logging may be effective with logging along parallel strips 10 to 15 km apart.

After logging operations the area should be abandoned and all access routes blocked. The area should be under guard and no activities other than preventive patrols allowed. During logging the work should be supervised by personnel from the conservation agencies, who should also survey the area before the operation commences. Special care should be taken not to disturb saltlicks and other places where rhino concentrate. The access to saltlicks should not be blocked

and in principle no activities should be allowed within about 2 km of a saltlick. If a female rhino with calf has been observed it will be better to ban all activities within 5 km of the saltlick.

The saltlicks are of great importance to the rhinos, at least in the mountainous areas. At lower altitudes they may be less important because of higher mineral concentrations in soil and water, but in the upper Wamas saltlicks form a focal point for the rhinos' distribution and activities. In designing a reserve it is important to know where these saltlicks are situated and to ensure their inclusion, as well as a good proportion of land around the lick, to allow free access. For many reserves this is not the case because the licks are usually found along the sides of the major valleys, where man has often settled already. Most of the saltlicks along the Alas valley are outside the park or are heavily disturbed. This could have contributed, together with the hunting, to the complete disappearance of the rhino from the slopes of the Alas valley since 1960. Now, except on occasional visits, rhinos are not found in the Alas valley despite there being a breeding population only some 10 - 15 km further inside the Gunung Leuser reserve.

In principle all saltlicks in an area should be included within the reserve, and extra care should be taken to avoid disturbance there. If all the area around a saltlick cannot be included in the park a wide corridor should be created to allow unhindered access by the animals. These areas should be well guarded because the concentration of animals attracts hunters.

Another point to consider is the location of the reserve boundaries. The larger rivers are good reserve boundaries as they are important features for the rhino and each individual usually remains on one side of the river. If it crosses the river it usually soon returns to its home side (see chapter 7.2). Boundaries along ridges are not recommended because the rhinos generally use both sides of a ridge and will spend much of their time outside the protection of the reserve.

Many of the valleys around the existing reserves are already heavily populated and usually the reserve boundary is located somewhere on the slopes. The rhinos living there are likely to cross reserve boundaries to visit the river before returning to the forest. On such visits they are in danger of being killed and may cause damage to crops. For new reserves and for extensions of existing reserves boundaries should be located along major rivers and if possible the boundaries of existing reserves should be moved from the slopes to the river bank.

The decline of the Sumatran rhino over most of its historic range is mainly due to heavy hunting pressure for horns and other parts of the body, for which there is a good market. Day to day management of a rhino population will therefore mainly consist of prevention and control of poaching. The vast mountainous reserves where the last rhino populations can be found are very difficult to control. Once people are inside the reserve they can only be detected by ground patrols who are very familiar with the area and who are skilled at reading tracks and are as hardy and daring as the poachers.

This means that in areas liable to rhino hunting special patrol units should be formed, from men familiar with the local terrain and capable of spending long periods in the field with minimal outside assistance. Many park guards have a city background or feel themselves too well educated for such physical endeavour, and it is better to form special units, with former poachers proving able recruits. These people know the area and the trade and can be very good field personnel, provided that their work can be controlled effectively.

In Sumatra rhino hunting usually involves traps and these are relatively easy to find. The hunters must visit their traps regularly and are likely to attract attention and leave very clear trails. Poachers must spend a lot of time and energy to bag a rhino and if the risks of the traps being discovered and destroyed are high, poachers will not take the trouble. Regular patrols in the rhino areas will deter most attempts to poach rhino.

In Borneo it is more difficult, because there rhinos are often hunted on foot, by persistent pursuit until the hunters get a chance to shoot the animals. These hunters are capable of living for a long time in the forest with a minimum of equipment, and they are more difficult to track. Here too however, patrol groups manned by former rhino hunters will be an active deterrent to would-be poachers.

11.3 - A strategy for survival of the Sumatran rhino

The Sumatran rhino is one of the most threatened mammal species in the world, with remnant populations scattered over several states. All are legally protected and part of the remaining habitat is protected in reserves. Other Sumatran rhino populations survive in remote parts of Southeast Asia, but very little is known about their status and all are threatened in some degree by hunting or loss of habitat.

To strengthen and coordinate the efforts of the national governments to protect and manage Sumatran rhino populations, a comprehensive and cohesive survival strategy for this species would be of great value. Such a plan should be multinational and collaborative in nature, should cover all aspects of conservation of the rhino over its total range and should be based on sound evaluation of the status of the existing populations. In such a strategy the following points should be included; they are not listed in order of importance.

- 1- Strengthening the legal basis and the management structures in the existing large reserves that harbour good rhino populations (Sumatra - Gunung Leuser, Kerinci; west Malaysia - Taman Negara, Badau-Rompin; Sabah - Tabin). Where possible park areas should be further extended.
- 2- Creation of more large (more than 7000 sq km) reserves in areas where relatively large populations of Sumatran rhino are still found. On Borneo such areas could be established in southeast Sabah, and in central Borneo if the rhino survives there. In Malaysia one might try to enlarge the existing reserves. A few large reserves should be established in Thailand and Burma, if good populations of rhinos remain there.
- 3- Strengthening of existing reserves or creation of new reserves of at least 1000 sq km where rhinos occur. Cooperative management schemes should be developed in adjacent timber production areas so that existing rhino populations are not eliminated and so that rhinos can survive in these areas after logging.
- 4- In areas where the habitat is under immediate threat and cannot be protected rhinos should be captured and translocated to other reserves or to a captive breeding unit.
- 5- Establishment of special patrol units in areas where the rhino is endangered by hunting. These units should be staffed with competent personnel and be sufficiently equipped and financed to be able to function properly.
- 6- Surveys of areas where rhinos are believed to occur to establish their range and to formulate management proposals. All existing reserves should be thoroughly surveyed to determine the distribution and density of rhinos.
- 7- Continued monitoring of the main rhino populations with a full-scale census at least every five years. This should be done by competent wildlife ecologists in cooperation with the anti poaching patrol units.
- 8- Better enforcement of the existing legislation concerning the protection of the Sumatran rhinoceros, and where necessary the creation of additional legislation and policing facilities, to deter poachers.
- 9- A complete ban on, and better control of, all trade in rhino products, and a campaign to replace the use of rhino horn in traditional medicines with other products that have similar effects but are not taken from rare and endangered animals.
- 10- Establishment and encouragement of research programmes in rhino areas, as their presence is a stimulant to better management and protection.

APPENDIX A: Hoofs of Sumatran rhino

A front hoof from each rhino identified in the study area is shown in figures A.1 to A.5. In figure A.6 and A.7 a selection of side hoofs is shown. All drawings are full-size.

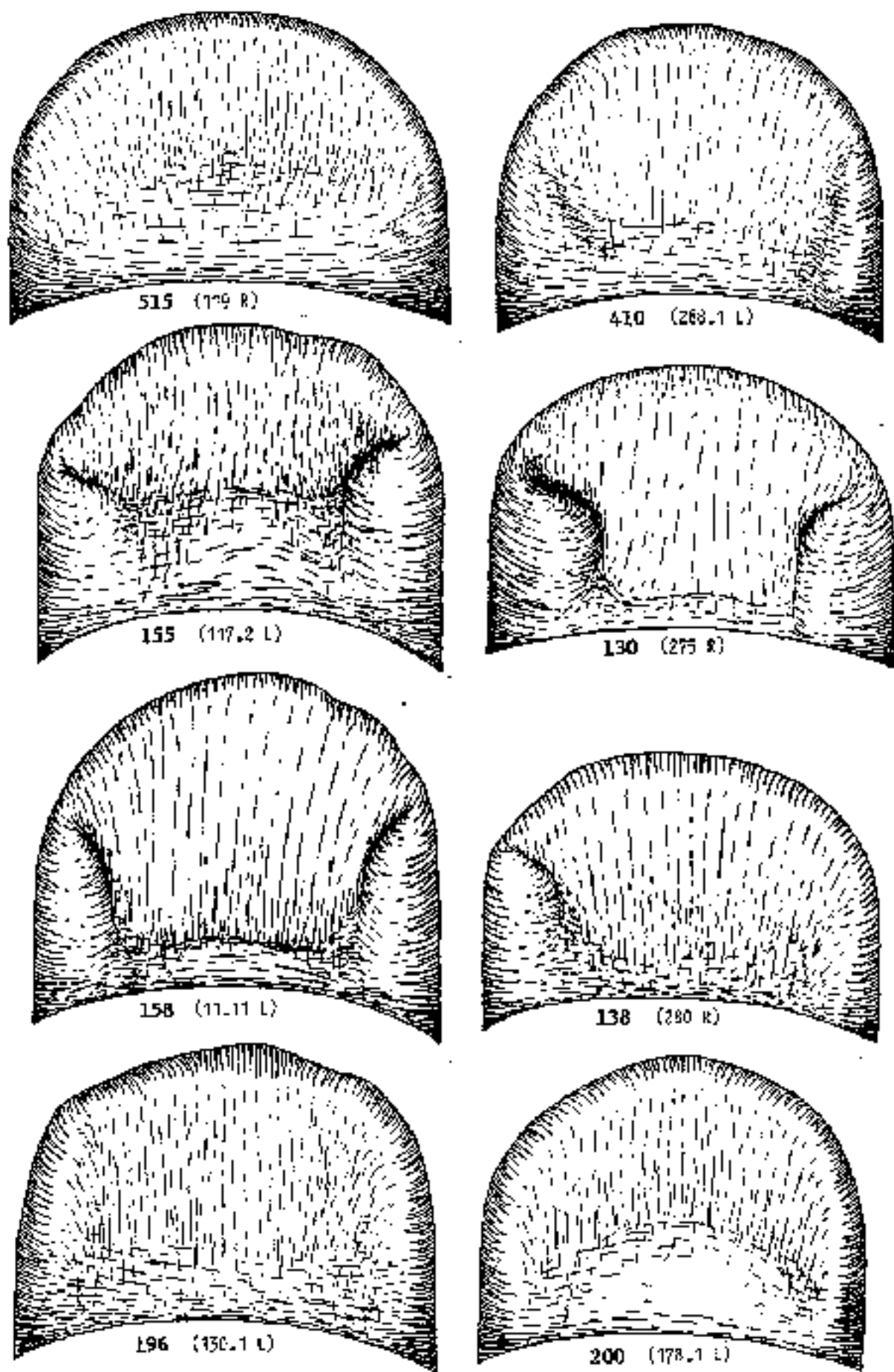

Figure A.1

Females (left) with their young (right) after separation

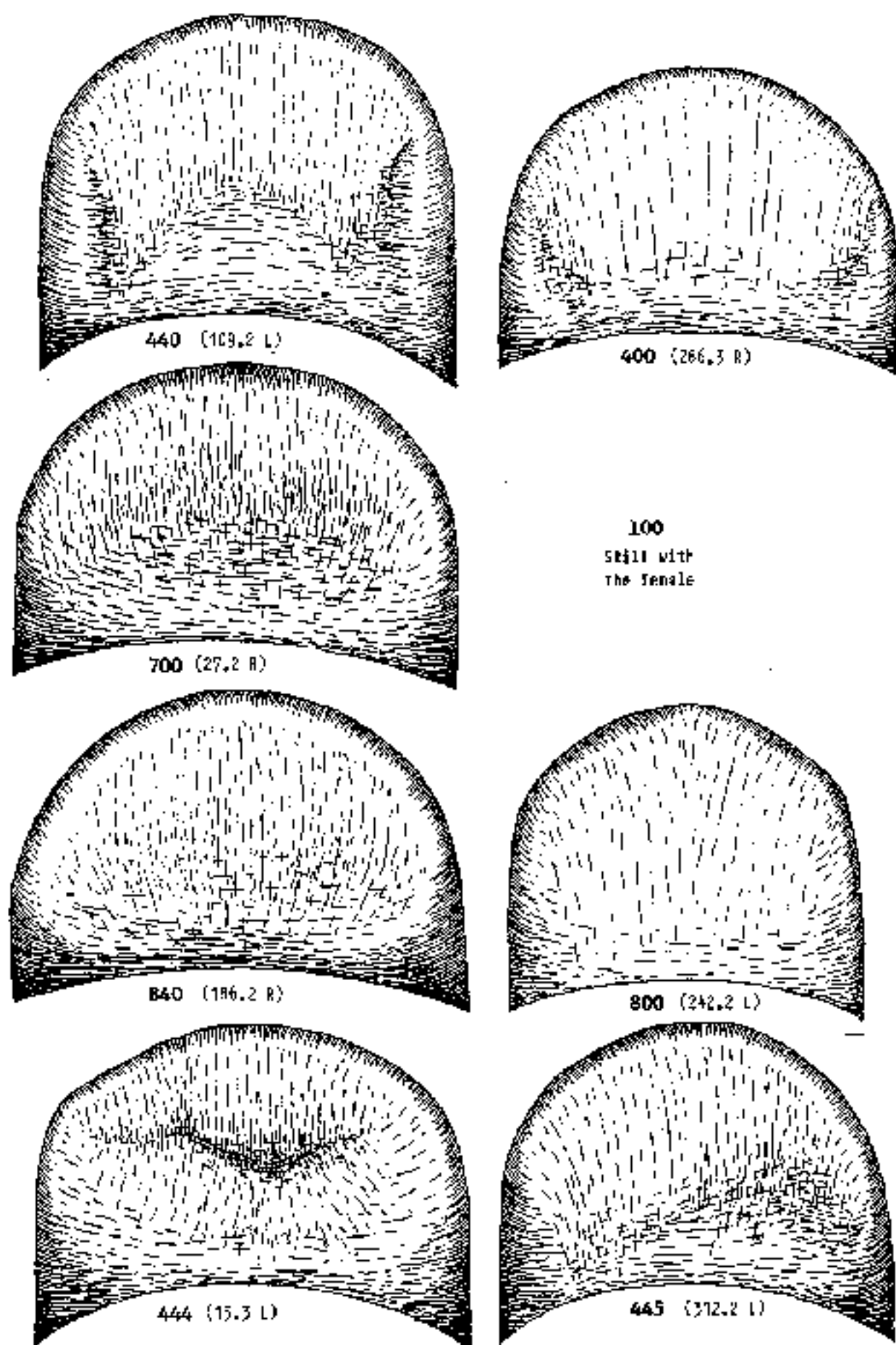
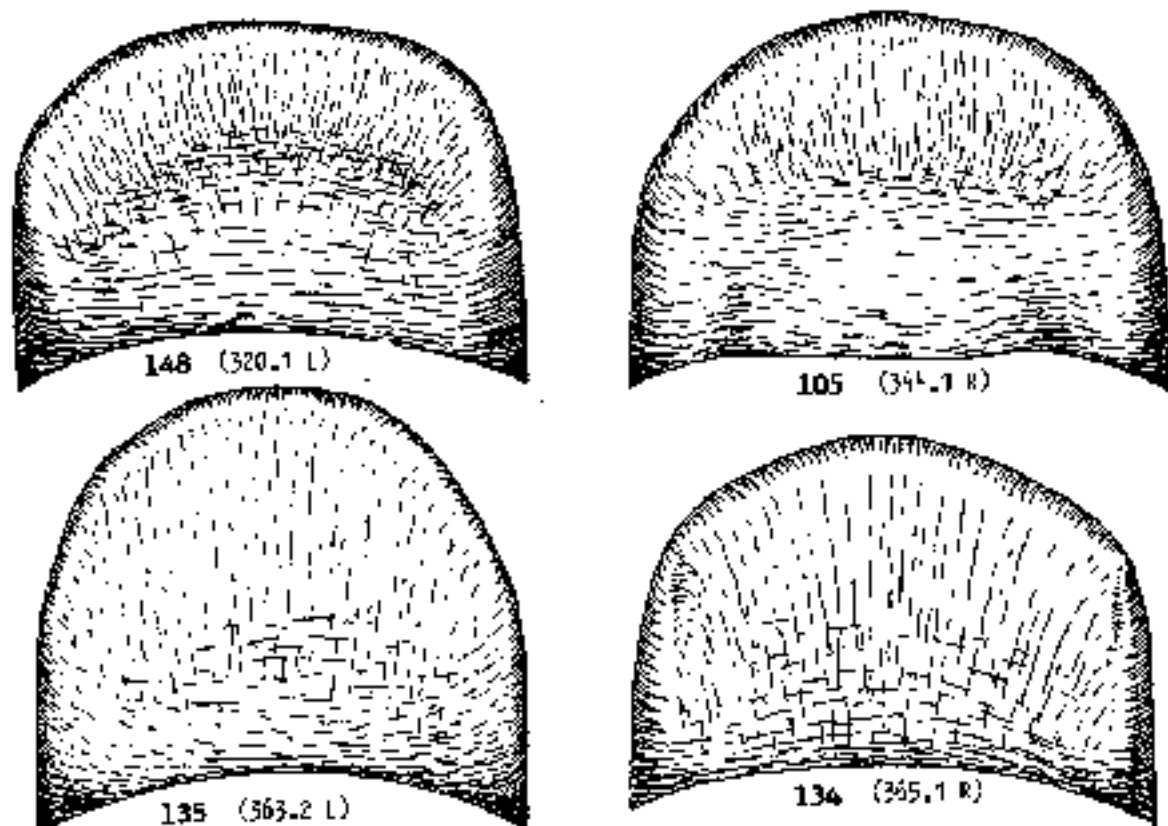
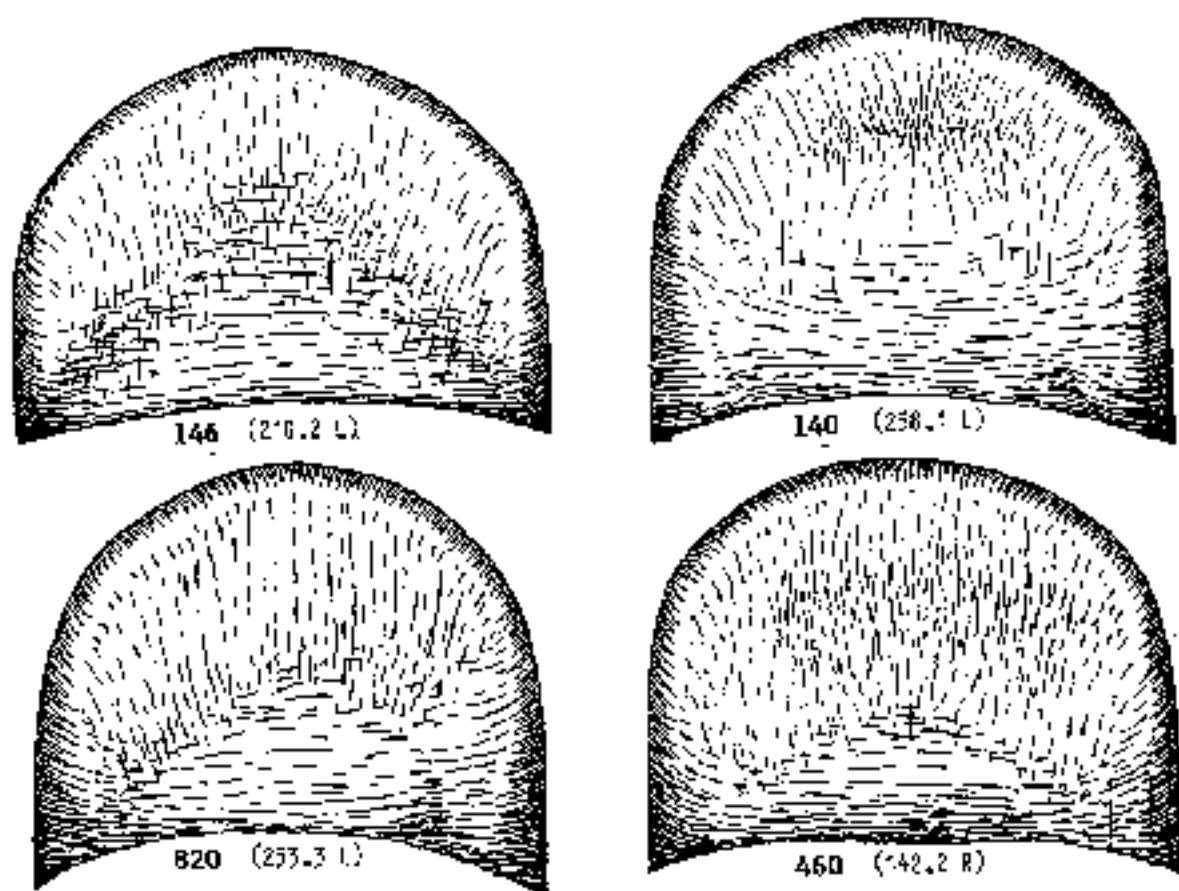

Figure A.2

Females (left) with their young (right) after separation



Unassociated young, born during the study



Sub-adults, born before the study

Figure A.3

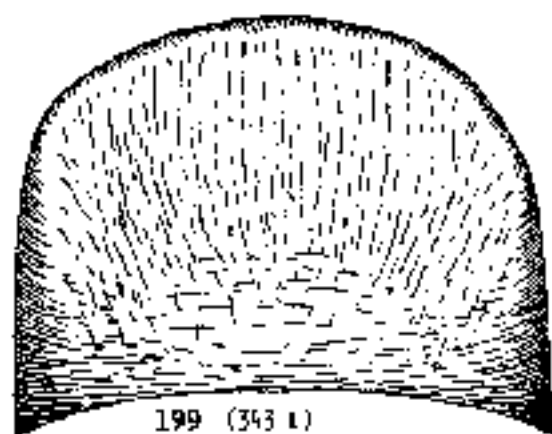

199 (34.3 L)

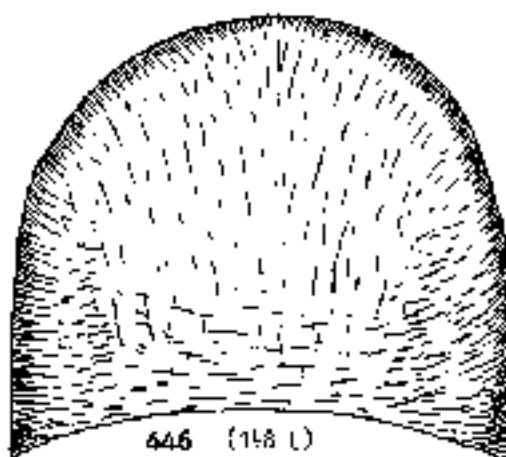

646 (48 L)

Sub-adults, horz. before the study

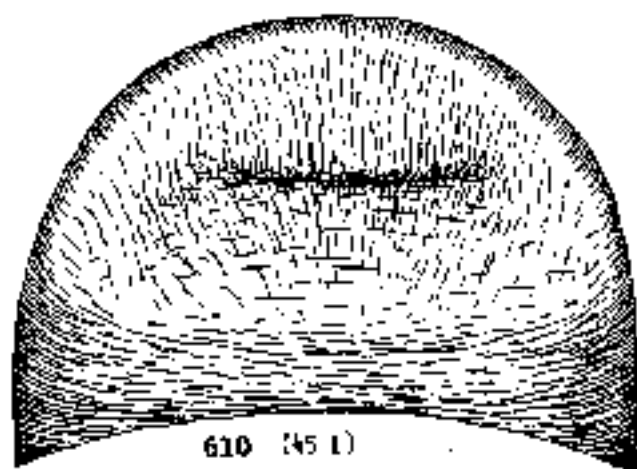

610 (45 L)

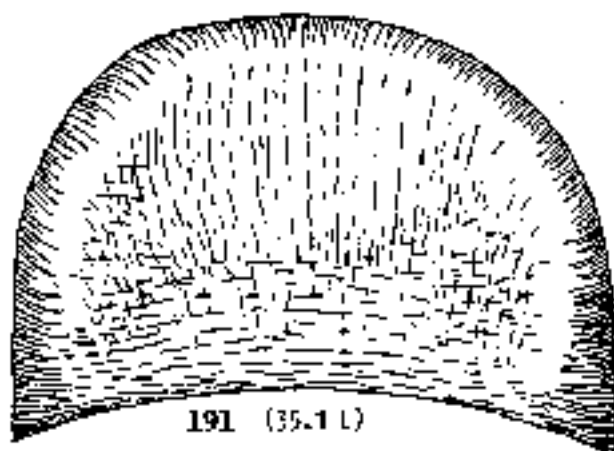

191 (35.1 L)

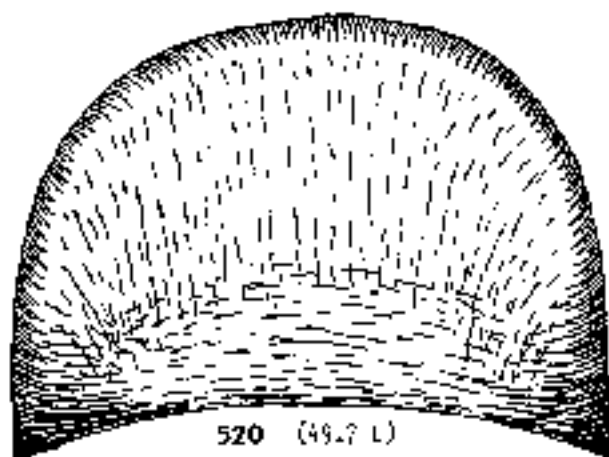

520 (49.7 L)

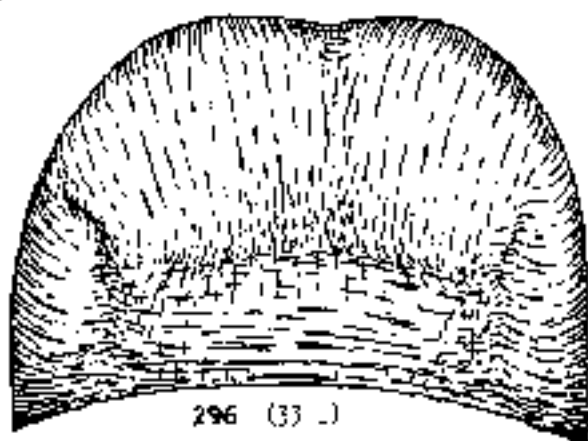

296 (33 L)

Melms

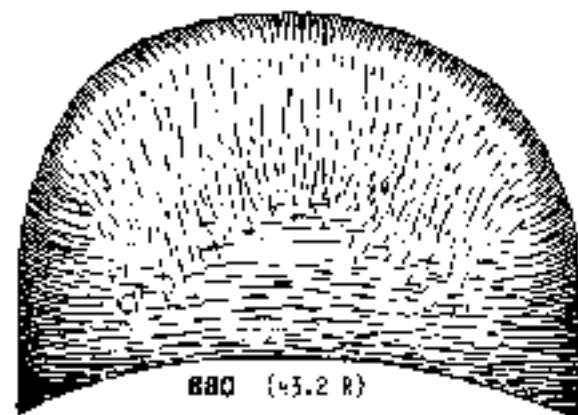

880 (43.2 R)

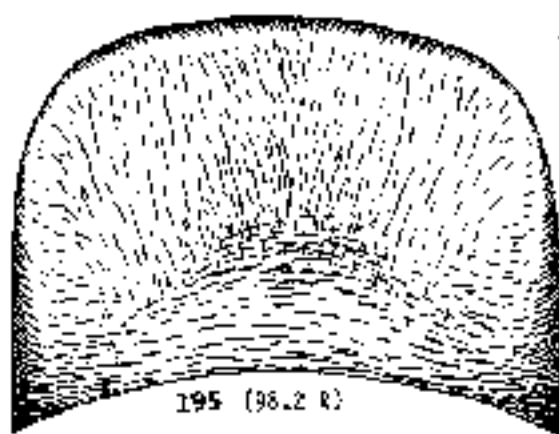

195 (38.2 R)

Figure A.4

Other adults

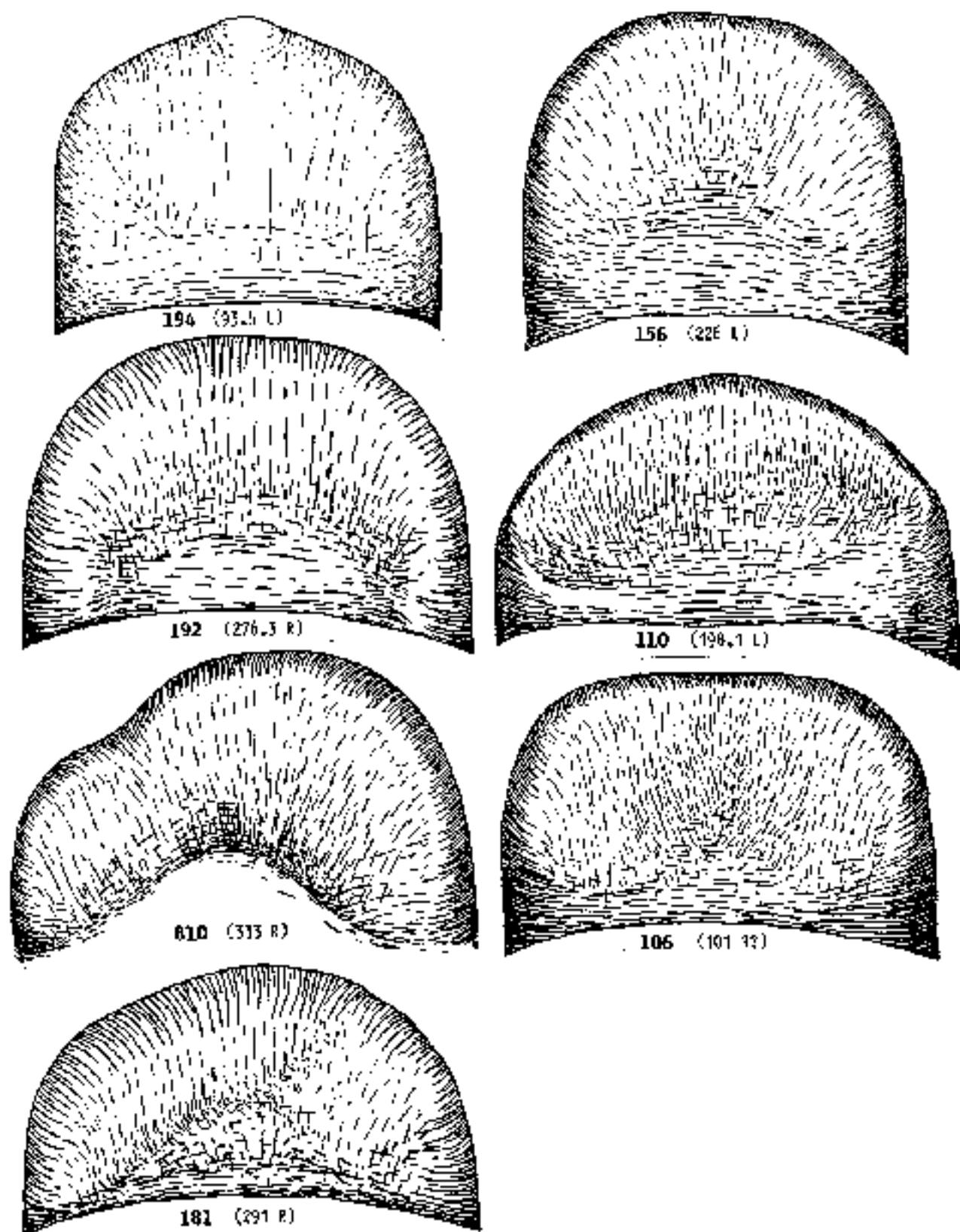

Other adults

Figure A.5

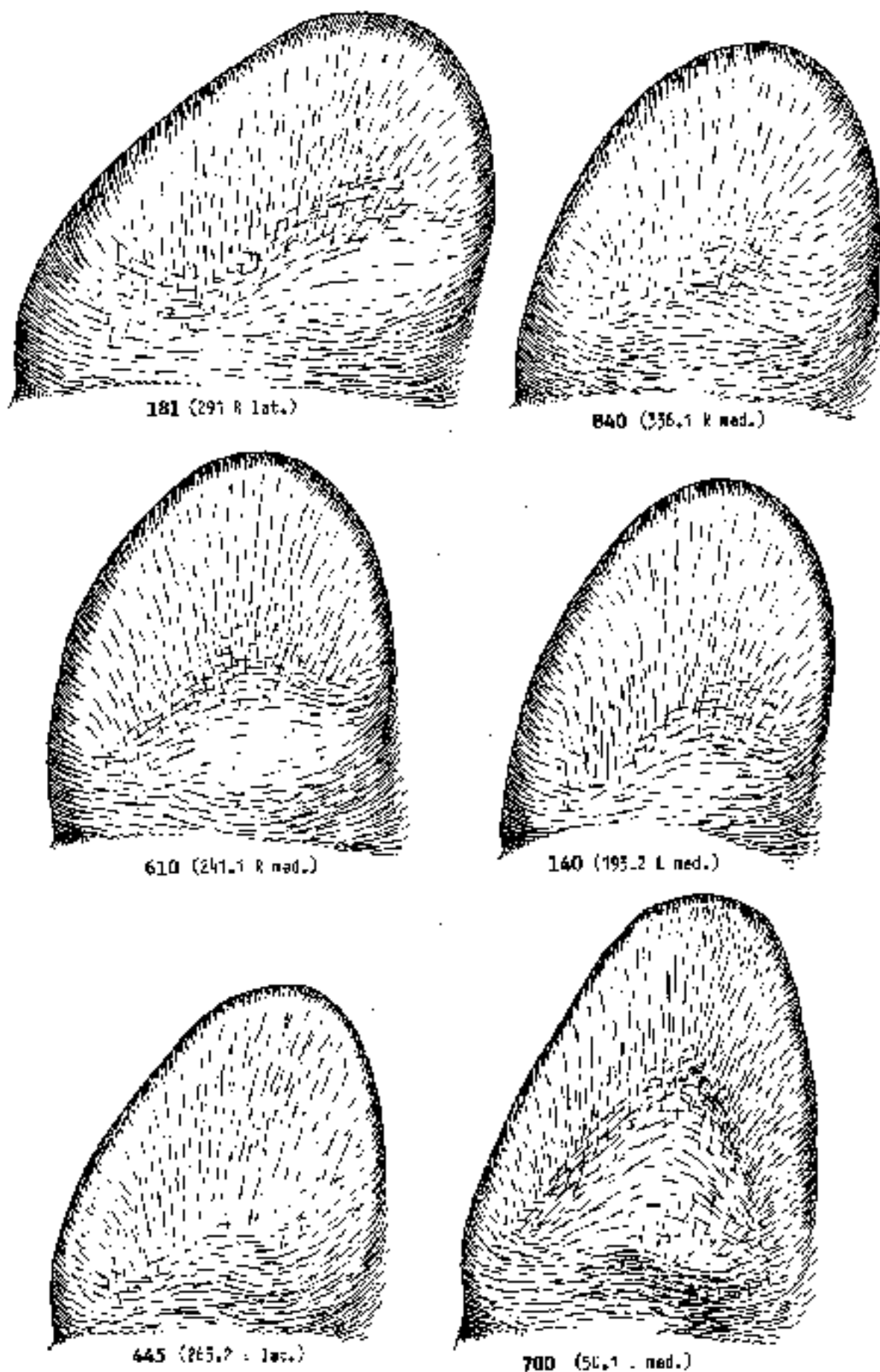
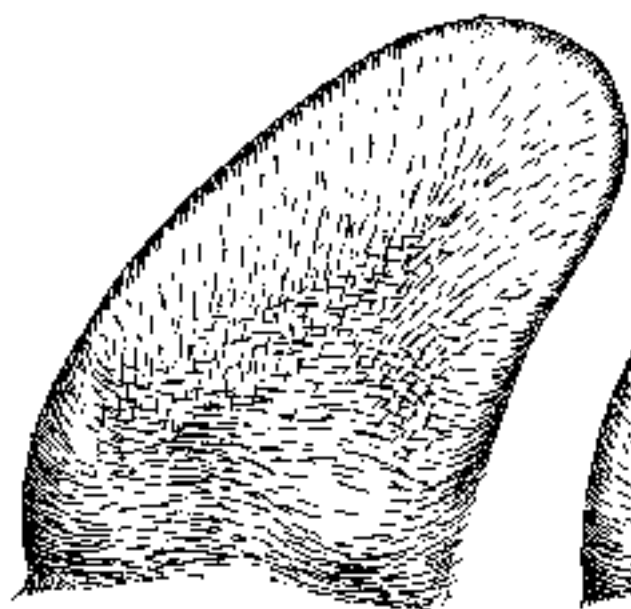
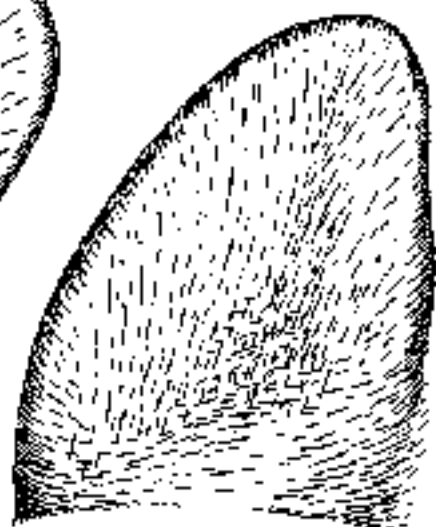

Figure A.6



158 (11.4 L lat.)



158 (64.1 R med.)

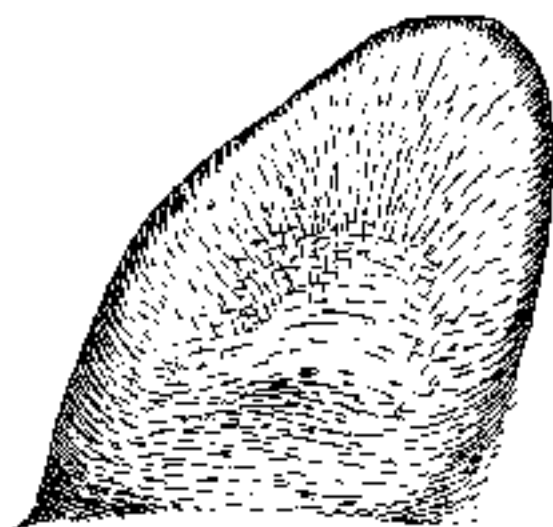

155 (117.1 R lat.)

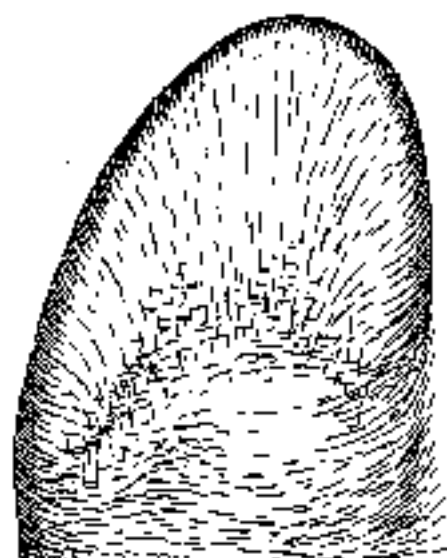

196 (71.1 L med.)

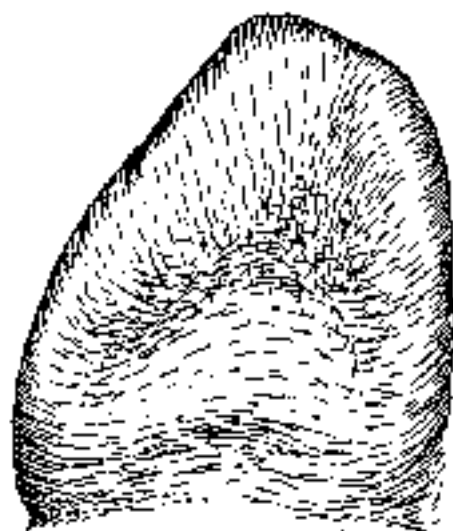

444 (15.3 L med.)

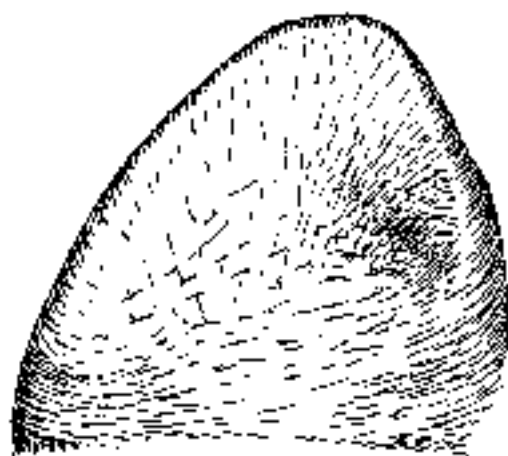

515 (262.1 L lat.)

Figure A.7

APPENDIX B: Present status of the Sumatran rhinoceros

The Sumatran rhinoceros is generally regarded as one of the most threatened mammals in this world. It has disappeared from most of its former range and the surviving animals are scattered over a number of isolated areas (see figure 1.1). The reasons for its dramatic decline are ruthless persecution for the valuable horn and other marketable parts, and the loss of most of the animal's natural habitat to the expanding human populations. Poaching and loss of habitat are continuing and the Sumatran rhino is not far from extinction.

There is certainly not much reason for optimism for the future, but the overall picture is not so gloomy as is often depicted in conservation literature. The remaining populations are indeed widely scattered, but a few are probably much larger than is thought at present, and with adequate protection these populations could safeguard the survival of the species at least for the immediate future. With some goodwill on the side of the authorities in the countries that harbour the remaining rhino populations these animals can be effectively protected and in several areas there is good hope that the present populations will survive in the long term.

The recent estimates for the world population of Sumatran rhinos are very low. In the latest edition of the IUCN - Red Data Book (1976) the estimated total population is 89 - 158. Borner (1979) estimates the world population to lie between 100 and 160 individuals, while Flynn & Abdullah (1983) expect the total number to be less than 300. Virtually no recent information has been received of the animal's status in Burma and Thailand, but more information is available for Malaysia, Sumatra and Borneo, and the figures for these parts of the rhino's range need reviewing.

B.1 - The situation in Sumatra

Outside Gunung Leuser there are a number of areas where rhinos are known to exist. The whole island was surveyed by Markus Borner, between 1973 and 1975 and the results summarised in his thesis published in 1979. Detailed accounts of his survey can be found in his progress reports for project 884, submitted to World Wildlife Fund (see references). More recently several areas on Sumatra have been visited by scientists working for WWF or for the UNDP/FAO National Parks Development Project, whose reports contain several interesting observations on the occurrence of rhino.

Rhinos occur, or may occur, in 7 or 8 different areas on Sumatra. These areas are shown in figure 1.1. Below the status of each area will be reviewed, beginning with the three strongholds of the rhino, in the reserves of Gunung Leuser, Kerinci-Seblat and Barisan Selatan. In an area as large as the island of Sumatra, and where access to many places is still limited, it is very likely that there will be other areas where rhinos survive but we cannot expect to find more large populations as in Leuser and Kerinci. The lowlands of Sumatra are now rapidly being cleared for logging, agriculture and resettlement, and soon there will be very little natural habitat left for rhinos outside the central mountain chain, the Bukit Barisan. But even there clearance is progressing and without adequate protective measures the rhino will soon disappear altogether.

Gunung Leuser National Park

The Gunung Leuser National Park (in Indonesia the term National park has no legal status, and exists only in ministerial decrees) forms the major stronghold of the Sumatran rhino. The number of surviving rhinos is much higher there than in any other area in Indonesia and elsewhere (with the possible exception of the Kerinci-Seblat area), and the field studies that have been carried out since 1973 have made this population the best known.

The distribution of the rhino is well-known (see figure 2.1). The main rhino stronghold is in the western half of the park, and covers an area of about 1000 sq km but rhinos can also be found, elsewhere in the reserve, but at much lower density - at Bengkong, Kapi, Langkat. In the eastern half of the reserve, which was extensively surveyed by Borner, rhino density is very low apart from in the central part of the Kapi plateau. On a survey in 1981 numerous signs of rhino were reported south and west of Gunung Kapi (pers. comm. C.G.G. van Beek and J. Wind).

The area around Gunung Kapi where rhino are abundant is fairly small, not more than about 300 sq km; in the surrounding areas only a few scattered individuals were found during earlier surveys. The high density area probably extends into the rarely visited upper Lestari valley, where locals report important saltlicks. This area is of great importance because it is the only place in the eastern part of Gunung Leuser where the rhinos seem to survive at a 'normal' density. The expanding human population will soon split the reserve in two along the Alas valley, and then migration of rhinos between the east and western parts of the reserve will be impossible. The Gunung Kapi area could then function as a breeding nucleus for restocking the eastern part of the reserve, where the rhino has suffered most heavily from poaching.

Borner estimated a total of between 22 and 43 rhinos for the whole of Gunung Leuser, but this is certainly an underestimate (see chapter 10.1). In the study area in the upper Mamas alone 39 individuals could be recognised and in the five years of the study 12 calves were born. For the Mamas a density of about 14 rhinos per 100 sq km was calculated. The Mamas is clearly a good area for rhino, and it could be that the rhino density elsewhere in the reserve is less. The Mamas is the lowest and least dissected part of the animal's range, and has a number of important saltlicks. Saltlicks are also present elsewhere in the Leuser complex and rhino hunters who accompanied a geological expedition into the most rugged and inaccessible part of the reserve by helicopter speak of an unusual abundance of tracks there. There is therefore no reason to regard the Mamas as an exceptional area and it is reasonable to take a figure of 10 rhinos per 100 sq km for the whole reserve.

This would put the minimum number of rhino in the western and eastern parts together at 130 animals, in 1300 sq km, about 15 % of the total area of Leuser. Including the few rhinos found elsewhere and for the possibility that the overall density might well be as high as it is in the Mamas, the best estimate for the surviving population of Gunung Leuser is between 130 and 200 individuals.

Kerinci-Seblat National Park.

The (proposed) national park Kerinci-Seblat covers a large section (about 15 000 sq km) of the Bukit Barisan range in central Sumatra, between the towns of Padang and Bengkulu. The area is a mosaic of forest-, nature-, game- and hunting-reserves, which was provisionally declared a national park in 1982. In general the legal status of this area is much weaker than that of Gunung Leuser, and the management infrastructure is poorly developed. In several parts there is heavy pressure from the human population, and without proper action the reserve will be fragmented in the near future.

Borner surveyed the Kerinci-Seblat area in 1974 and found evidence of rhino in several places. In the area of Danau Tuju (or Tujuh) tracks and faeces of rhino were found and Borner describes the area as "a rhino region comparable to the Gunung Leuser area. Many rhino trails can be found. However, most of them are overgrown, indicating that the rhino population is very small and at the edge of extinction."

Near Lampung, on a plateau southeast of Lake Kerinci, Borner found wallows, indistinct trails and fresh tracks of at least three different rhinos, including a cow and calf pair. Borner writes that "the region surveyed is probably only the periphery of the rhino area. I suspect the core area to be situated in the mountain ridge to the east."

In the Sungai Seblat area, northwest of Muara Aman, fresh tracks were found. Borner writes that he "found fresh rhino tracks in the middle part of Sungai Seblat, north of Air Putih. They were about one day old and very large. The width of the hindfoot was between 25 and 26 cm, which is the largest rhino track I have ever found. I found no evidence of trails, feeding marks or wallows, and I think that I penetrated only the periphery of the rhino area."

Borner estimated a total of 15 - 20 animals for Kerinci-Seblat and concluded "that there is a remnant population of rhinos, which is surviving in the mountainous area at the boundaries of Jambi- and Bengkulu-Provinces. A small corridor is leading further north to Gunung Tuju and probably Gunung Kerinci." (Borner, 1974)

In recent years rhino have been reported from a few other places. In 1979 fresh rhino tracks were reported about 2 km from the road from Muara Labuh to Sungai Penuh, in the Kabupaten Pesisir Selatan (Gunung Bonkar). The tracks were reported to be very abundant (Suharto Djoesudharmo, 1979).

In 1980 fresh tracks were found in an area south of Lampung in the Tebar Palápo or Tebar Selapo area. The tracks were found in an abandoned resettlement area. They were about 1 day old and measured 25.5 cm. In 1983 a rhino was killed there (pers. comm. R.Y. Bangun Mulya). In the same report it is mentioned that a team from Bandung searching for gas sources found fresh rhino tracks near Gunung Sumbing (or Sumbing) (de Wulf & MacKinnon, 1980).

Game guards reported rhino from the Rawas Ulu Lakiton area, near Lebuk Linggau (pers. comm. Widodo Sukahadi), and from the Air Simpang Seblat and Hulu Melam (de Wulf, 1979?). In the Management plan for the proposed national park the number of rhino is estimated as "at least 15, but it is quite possible that as many as 100 could still survive". (de Wulf, Djoko Supomo & Kurnia Rauf, 1981).

In 1983 and 1984 Raleigh A. Blouch surveyed several areas in southern Sumatra and found tracks of rhino in several parts of Kerinci-Seblat. Most signs were found along an old trail leading from Lampung in the Kerinci enclave to Muko Muko on the coast of Bengkulu. Tracks of several different rhinos and cow and calf pairs were reported there. Along the southern edge of the park, between Tapus and Lubuklinggau an old wallow was found but no recent evidence of rhino. In 1982 a rhino was killed in a village west of lake Kerinci. Another dead rhino was reported in the same year from near Lebong Tandai (Blouch, 1984).

Figure B.1 shows the locations of the rhino reports. The northern population is probably already isolated from the southern population, where there is still a vast area of undisturbed and unexplored forest. Most of the interior of the reserve has never been surveyed and it is most

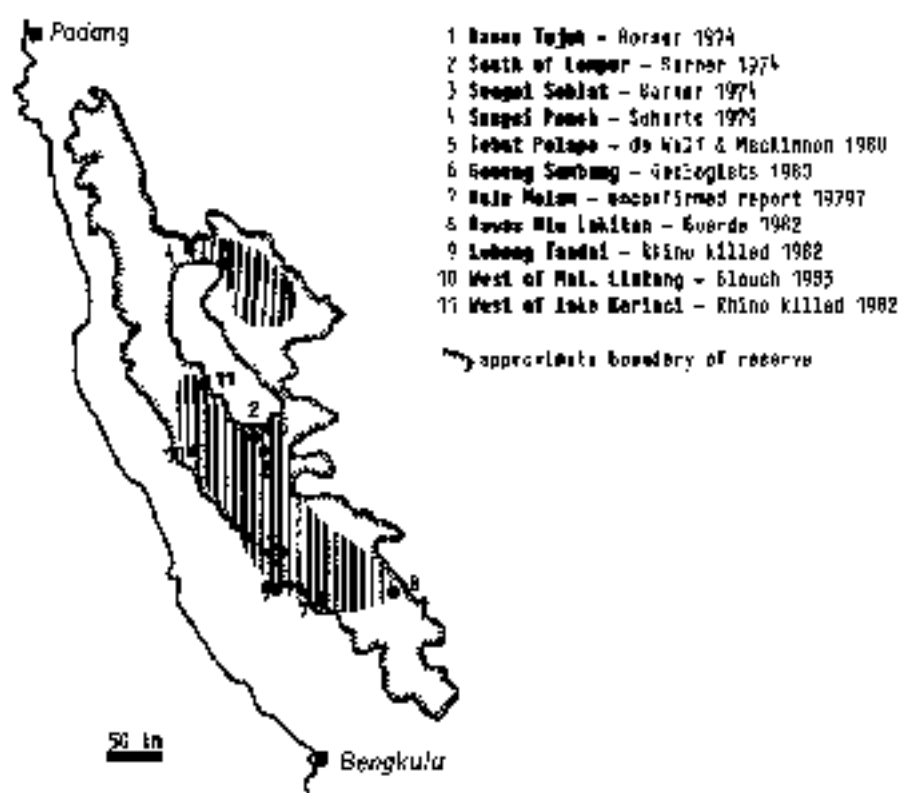

Figure B.1 - The proposed Kerinci-Seblat National Park with the locations of recent rhino records and the inferred distribution of rhinos

likely that the places where rhino are reported, the fringes of the reserve, are the perimeter of a continuous distribution covering most of the reserve. The total rhino distribution in Kerinci-Seblat may correspond to the shaded area in figure B.1, covering about 1000 sq km in the north and about 4000 sq km in the southern part of the reserve.

It appears that the rhino area in Kerinci-Seblat is even larger than that in Gunung Leuser. Several reports speak of abundant tracks and compare the area to Gunung Leuser, and there is no reason to expect the density to be substantially different from that in Leuser. In that case there may be as many as 500 animals in the Kerinci-Seblat area. But in view of the fact that large parts of the reserve have never been thoroughly surveyed a safe figure could be 250 - 500 animals.

Barisan Selatan Game Reserve.

The Barisan Selatan reserve (also called Sumatra Selatan 1, Sumsel I or SS 1), covers the most southern part of the Bukit Barisan range. The reserve is much smaller (about 3600 sq km) than Leuser or Kerinci and it is under heavy pressure from the rapidly expanding human population. The areas legal status is comparatively good, but the management structures have only been developed in recent years and are still inadequate. The reserve will soon be fragmented if the encroachments cannot be stopped.

Borner surveyed the area in February and March 1975. In the southern part of the reserve he found no evidence of rhinos, but locals reported a sighting in 1974 at the Wai Kedjadian and tracks in 1972, west of the Kedjadian river. In the central part of the reserve tracks were found in two places - in the area of Wai Siran and between the mountain range south of Liwa and the Handaring river. A rhino was reported to be killed east of Liwa in 1974. Borner concluded that "well maintained rhino trails and feeding marks indicate that a small resident rest-population of rhinos is still surviving in the northern (sic) part of the Sumatra Selatan I reserve." He estimated the total number of rhinos at 2 - 5 (Borner, 1975). The area where Borner found the tracks is in the central part of the reserve as it is designated now, and the large part of the reserve north of Danau Ranau has apparently never been surveyed in recent years.

In 1981 tracks were found in the southern part of the reserve near Way Paya, and in 1982 tracks were reported from Wai Belambangan, and a rhino was sighted at Bukit Penotoh (pts. comm. Widodo Sukahadi). In the management plan for the reserve it is stated that "the status of the Sumatran rhino in Barisan Selatan is not clear... In the past there must have been a

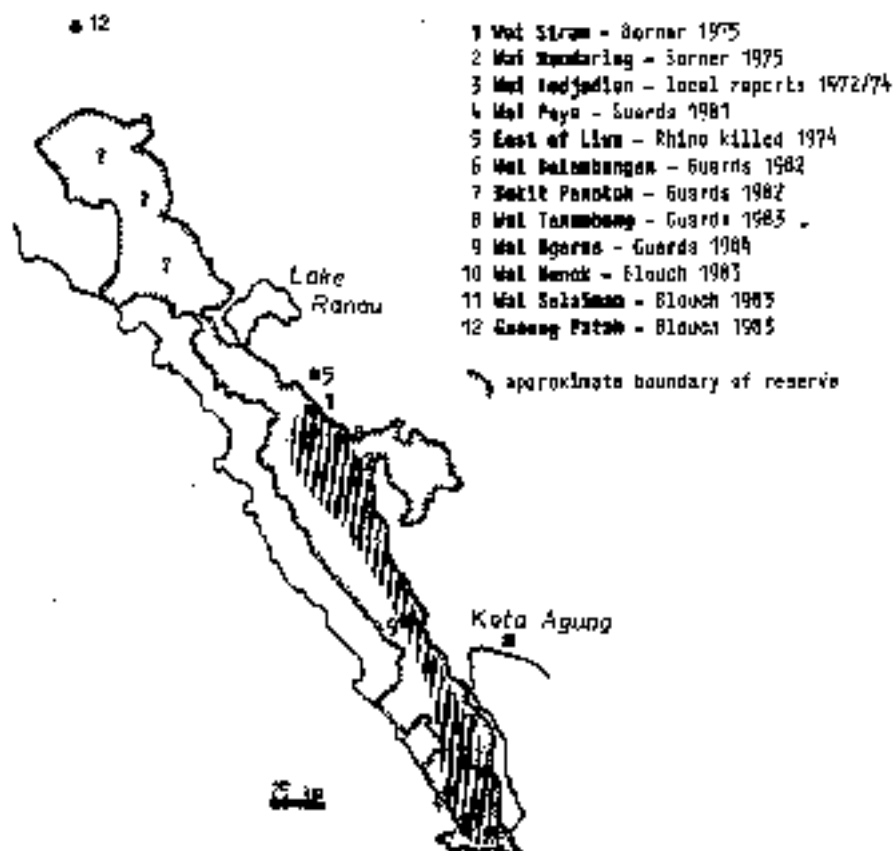

Figure B.2 - The proposed Barisan Selatan National Park with the locations of recent rhino records and the inferred distribution of rhinos

good-sized population of rhino in Barisan Selatan, however scattered, as these are solitary animals. The rapidly dwindling primary forest of the reserve makes the survival of the rhino very doubtful." (de Wulf, Djoko Supomo & Kurnia Rauf, 1981).

In 1983 Blouch found evidence of the occurrence of rhino in Barisan Selatan. In the southern tip a track was found near the Way Nenok cave in the headwaters of the Paya river. Game guards reported a track further south near Way Salsiman. In the central part of the reserve abundant signs of rhino were found about 10 km south of Way Laga in the headwaters of the Tejuhbang river. In 1984 game guards found a rhino track in the upper Ngaras river, where the park is only few kilometres wide (Blouch, 1984).

Rhinos survive in two areas of the reserve, and probably still have a continuous distribution throughout the southern half of the park. They may also still occur in the north. The total area, shaded in figure B.2, is relatively small, not much more than 700 sq km and the number of surviving rhinos cannot be very high. A reasonable guess appears to be between 25 and 60 animals left in Barisan Selatan.

Gunung Patah Protection Forest

This is an isolated block of forest, about 700 sq km, on the border between the provinces of Sumatra Selatan and Bengkulu. It is classified as protection forest, but it receives little actual protection. In 1983 rhino tracks were found there for the first time by Blouch. Several signs of rhino were encountered at the edge of the undisturbed forest, a few kilometres south of the village of Tebar Benawa. Rhinos were reported to be common in this area some time ago and the extent of this population should be further investigated (Blouch, 1984).

Berbak Nature Reserve

Berbak nature reserve on the east coast of Sumatra is often mentioned as one of the places where the Sumatran rhino still survives. When Barner visited the reserve in November 1974, he found no evidence of rhino. Villagers reported tracks in the vicinity of Simpang Kubu

(Borneo, 1974). At B. jering and Camara in the southeastern corner of the reserve very fresh rhino tracks were reported in 1976. The tracks were large (26.5 cm width and distance between forefoot-forefoot 180 cm) and it was suggested that they were probably made by the Javan rhino (*Rhinoceros sondaicus*) (Wind, 1976).

When the area was surveyed for the preparation of a management plan no evidence of rhino was found, and the rhino was presumed to be extinct in the Berbak reserve (de Wulf, 1982). In 1983 three graduate students from the Department of Nature Conservation at Wageningen University surveyed most of the reserve, and they also failed to find any evidence of rhino (Silvius, Simons & Verheugt, 1984). In 1983 Blouch surveyed the eastern part of the reserve, south of the Hitam Laut river without finding any evidence of rhino and the game guards' reports are also negative. Therefore it seems that the rhino is indeed extinct in the Berbak reserve, at least in the eastern half. A few might survive in the western half, which is seldom visited.

Torgamba.

The Torgamba area lies on the border between the provinces of Sumatra Utara and Riau, southeast of Rantoprapur. Borner surveyed this area in December 1973, and he found fresh and old tracks about two day-trips north of the Asahan basecamp. In 1975 again tracks were reported by Laurie and McDougall, east of the Asahan basecamp, close to the provincial border (Borneo, 1979). Borner estimated 1 to 5 animals for the Torgamba area.

In 1977 a small population of Sumatran rhino was reported in the area between the Rokan and Berumen rivers in Riau. No details are given and it is most likely that reference is made to the Torgamba reports (Seidensticker, 1977).

The area was a forest reserve, but a large part has been converted to oilpalm plantation and the rest is a logging concession. The logging company is expected to receive permission to clearcut and there seems to be no hope for the survival of the rhino (pers. comm. K.S. Depari, 1982). In 1984 Blouch found rhino tracks in the area. As the area is cleared for plantations there seems no hope for survival of the rhino (pers. comm. R.A. Blouch).

Gunung Abongabong and Lesten-Lukup.

In the province of Aceh, north of the Gunung Leuser National Park, there are still large areas of undisturbed and unexplored forest. In the course of the present study many reports from villagers were received about the occurrence of rhino in the mountain areas north of Gunung Leuser. It seems certain that rhino do exist there, but there is no information about the range and size of the populations. Sizeable populations may still occur in the remote areas around Gunung Abongabong and the villages of Lesten and Lukup.

B.2 - The situation in Borneo

The Sumatran rhinoceros of Borneo is considered to be distinct from that of Sumatra and the mainland. The teeth are relatively small, the skull is slightly different in proportions, and the animal is believed to be smaller. It is described as a separate subspecies - *harrissoni* Graves, 1965.

The situation for the rhino in Borneo is much more serious than it is in Sumatra. The rhino has vanished from most of the island, and there are virtually no populations left in reserves. The more rapid decline on Borneo can be attributed to the greater hunting skills of the Bornean island people. Most tribes are living in and from the forest, while the tribes in Sumatra are more agriculturists than hunters.

In a recent review of the status of the rhino in Borneo (Rookmaaker, 1977) the author concludes that the animal's present status "can only be guessed since practically no reports later than 1945 are known. A few wandering individuals, or tiny remnant populations, may still occur in the ulus of the Mahakam, Kayan and Bahus rivers, and in northern Kalimantan Timur. More detailed information does not exist."

The last reliable report of rhino in the Indonesian part of Borneo, dates from 1976, when two sets of tracks were reported from the Banumuda area, north of the Kutai Game reserve (van der Zon, 1977). In 1980 a survey was made in this area to establish the animal's presence, but no signs of rhino were found. It was concluded that there is no viable rhino population in the Banumuda nor has there been any in the recent past, and that the reported tracks were most likely made by a stray animal driven out of its original range by logging disturbance. In and around the Banumuda area there were thousands of people in the field for logging and gas surveys but rhino signs were apparently never seen (van Strien, 1980).

Elsewhere a few rhinos may survive in some parts of the central mountain chain, but so far this has not been confirmed. The Bukit Raya area was surveyed in 1976, but no evidence

of rhino could be found and the local villagers believed that no rhino were left in that area (van der Zon, 1977). In 1981 a survey was made of the upper Kayan and upper Mentarang (in the northwest corner of East Kalimantan, bordering Sabah and Sarawak), but again no signs of rhino were seen and the local villagers believed that no rhino remained and that the animal's disappearance was due to heavy hunting by their fathers generation (Blower, Wirawan & Watling, 1981).

In 1973 a rhino hoof and faeces were confiscated by game guards near Nunukan, close to the Sabah border. The rhino was reported killed by Dayak Punan villagers (pers. comm. Widodo Sukahadi). In 1978 one or two rhinos were reported to have survived in the Maara Teweh area (Darpoa Dirap, in letter 21 March 1978, UNDP/FAO files in Bogor). In June 1982 reports appeared in the Indonesian press that in West Kalimantan, in the village of Belarung (apparently upper Kapuas) a herd of 20 tri-horned (sic) rhinoceroses were seen.

There are persistent rumours that hunters from northern Sarawak regularly cross the border with Indonesia to hunt rhino there, and that each year several are killed (pers. comm. K. Proud and J.R. MacKinnon). In 1981 or 1982 a rhino hunter was apparently caught by the Sarawak border patrols and the remains of the rhino were confiscated.

These reports indicate that there might be rhinos left in some forgotten corners of this vast island. If the rumours are true there might be a few rhinos left somewhere along the Kalimantan-Sarawak border, probably in the upper Kayan or upper Mahakan. This needs further confirmation, but the chances that a viable population can be found in the Indonesian part of Borneo are extremely slim. The rhino is probably not extinct but very rare.

In Sarawak the rhino has not been recorded for many years and is almost certainly extinct, but in Sabah the situation seems better. In recent years large parts of Sabah have been thoroughly surveyed and it appears that there are more rhinos left than was expected. There is a breeding population, estimated at about 20 animals, in the Silabukan and Lumerau forest reserves. There are rhinos in several of the areas being opened up or due to be opened up for agricultural development and in the extensive, continuous block of forest reserves in south/south-eastern Sabah. In total there are at least 13 rhinos in Sabah, and the actual number is more likely to be around 30 (Andau & Payne, 1982).

The reason that the rhino has survived in southeast Sabah, while it has been virtually exterminated elsewhere in Borneo, is probably because of the absence of real hunting tribes in this area. Only in recent years have groups of hunters moved into this area creating a serious threat to the few surviving rhinos (pers. comm. J. Payne). Recently a part of the known range of the rhino has been protected (Tabin wildlife reserve), but the rhinos cannot be effectively protected against hunters because of lack of staff (pers. comm. P.M. Andau).

B.3 - The situation in Malaysia

As in Sumatra and to a lesser extent Borneo, the situation for the rhino in Malaysia is not so hopeless as was previously thought. In 1972 the Red Data Book still gave an estimate of 10 to 30 rhino for west Malaysia, while the most recent estimate is between 50 and 75 (Flynn & Abdullah, 1984). This is not due to an increase in numbers of the rhino (on the contrary the population probably declined), but to a better knowledge of the species' distribution.

Throughout the country rhino occur in 13 different areas, but in only two areas, Endau-Rompin and Taman Negara, are the estimates of significant size. In Taman Negara 8 to 12 animals are estimated, from reports over a large part of this 4343 sq km reserve (Flynn & Abdullah, 1984). Although the density of rhino appears to be very low everywhere in the park, the estimate may be too conservative for an area of this size.

The Endau-Rompin area is the best studied area, and currently 20 to 25 animals are estimated to survive in 1600 sq km. The central part of the reserve - about 400 sq km - has a higher density of 1 rhino per 40 sq km, calculated from track counts (Flynn & Abdullah, 1983). Using the same data, but calculating the area of the census over a strip of 1 km instead of 2 km (as is recommended in this study) gives an estimate of a total of 30 to 40 rhinos instead of 20 to 25 (see chapter 10.1). Most of the remaining rhino habitat is now protected (pers. comm. Mohd. Khan).

The third largest rhino population in Malaysia is the Sungai Dusun reserve. For many years it was believed that three rhinos were living there. Now the figure is put at between 4 to 6, again because the area is now better surveyed. It seems to be the rule that in areas where there are rhino left, the numbers tend to rise the better the area is surveyed. Since many of the other rhino locations in Malaysia are only poorly known and surveyed, there is good hope that the present estimates there are also too low.

B.4 - The situation in other countries

There is virtually no reliable recent information about the status of the rhino in the rest of its range, in Thailand, Burma and Indochina. Most existing reports date from 10 or more

years ago and many of the areas in which rhino may survive are in regions that are plagued by various kinds of political unrest and where the nature conservation agencies have little or no access. It is of little use to mention all the areas believed to harbour rhino some ten or more years ago, since no recent information is available. Surveys of these areas should be a priority as soon as practical.

B.5 - Summary of the present status of the Sumatran rhino.

Sumatra (Summary of B.1)

Kerinci-Seblat	Probably the largest contiguous population. Imperfectly known, but estimated at between 250 and 500 individuals.
Gunung Leuser Barisan Selatan	The best known population. Estimated at between 130 and 200. Rhinos survive in the southern half of the reserve. Imperfectly known. Estimated at between 25 and 60 individuals.
Gunung Patch	Rhino surviving but numbers unknown.
Gunung Abong-abong	Unknown. Rhinos surviving in unknown numbers.
Leuser - Lukup	Unknown. Rhinos surviving in unknown numbers.
Torgamba	Unknown. A few surviving, but habitat threatened.
Barbak	Last report 1976, now probably extinct.
Total Sumatra	400 to 750 rhinos surviving in reserves and an unknown number in two or three other locations.

Borneo (Summary of B.2)

Sarawak	Extinct many years ago.
Kalimantan	Extinct over most of the area. Probably some surviving in the Kalimantan-Sabah border area and scattered remnants here and there. Possibly a larger number on the Kalimantan-Sarawak border.
Sabah	15 to 30 individuals, mainly in the Silabukan area and in southeast Sabah.
Total Kalimantan	One viable population in the east of Sabah and possibly some in the centre of the island. Insignificant remnants elsewhere. Extinct over most of the area.

Malaysia (From Flynn & Abdullah, 1984 and Khalifah Mohd Shariff, 1983)

Endau-Rompin	Probably the largest population in Malaysia. Estimated at between 20 and 25, but could very well be more.
Taman Negara	Second largest population. Estimated 8 to 12, but might be more. Imperfectly known.
Sungei Dusun	Small population. 4 to 6 individuals. See also: Mohd Zuber bin Mohd Zam, 1983.
Mersing coast (Tenggarih)	At least two left in an isolated patch of forest. One trapped in 1983 (pers. comm. Mohd Khan).
Gunung Belumur	Latest report 1980. Small surviving population. Imperfectly known. Estimated 2 - 3.
Bukit Gebok	Latest report 1980. One or two animals in a small isolated patch of forest, that has since been cleared. Probably extinct now.
Sungei Lepar	Latest report 1979. Unknown, 3 to 5 may survive.
Ulu Selama	Latest report 1983. Unknown, 3 to 5 may survive.
Kuala Balah	Latest report 1977. Unknown, 3 to 4 may survive.
Sungai Depak	Latest report 1976. Unknown, 3 to 5 may survive.
Ulu Belum	Latest report 1972. Unknown, 3 to 5 may survive.
Krau Reserve	Latest report 1963. Unknown, probably extinct now.
Kedah Border	Entirely unknown. A few might survive.

Thailand (From McNeely & Laurie, 1977)

Phu Khio	Latest report 1976. Unknown. McNeely & Laurie found tracks at four different places in four days in the field. This indicates that a few animals survive.
Khao Sol Dao	Latest report 1974. Species uncertain. Unknown.
Surat Thani province	Unconfirmed reports.
Thai-Burma border	Some may survive (pers. comm. Pong Leng-Ea, 1979).

Burma (From U Tun Yin, 1980)

Shwe-u-dzung game sanctuary	Probably extinct
Tumabthi game sanctuary	4 may survive
Lassoi tract	6-7 may survive

Indochina (From Rookmaker, 1980)

The presence of the Sumatran rhino in the Indochinese region cannot be confirmed and the few animals that might survive (e.g. south Laos and Vietnam) are most likely Javan rhinos Rhinoceros sondaicus.

APPENDIX C: Rhino poaching in the Gunung Leuser reserve

Hunting of rhinoceros is a traditional trade in north Sumatra, usually carried out by a small number of people, called "pawang badak", who lead a group of rhino hunters and who have a certain status and esteem in the local community. Many pawangs are from the Gayo tribe, natives of the mountainous interior of Aceh, but men from other tribes, Aias, Barak, Aceh etc. are also involved. It appears that all pawangs from the area north of Gunung Leuser are supervised by the pawang from Kampong Porang, near Blangkejeren. Without his permission and blessings another pawang should not go out to hunt, but it is not clear how strictly this is maintained.

Rhino hunting has occurred everywhere around Gunung Leuser and eliminated rhinos from all areas within two or three days walking distance from human settlements. In the border areas of the park one can still see old abandoned trails and wallows, but it is clear that they have not been used for a good many years. In the Aias valley the rhino disappeared from the lower slopes probably before 1960. Elsewhere as on the highlands near mount Leuser, they disappeared before 1930.

Old traps and camp sites of rhino hunters can be found on the borders of the reserve, reminders of the days when rhino used to roam over most of the reserve. At the time of the present study the rhino was already confined to the remote interior of the reserve, where it was believed that the rhino poachers had not yet penetrated. It was a surprise therefore when on the first expedition to the Mamas new rhino traps were found, showing that the poachers had already found their way into the last stronghold of the Sumatran rhino in Gunung Leuser. Here only the events in the Mamas will be described. For other information on rhino hunting around Gunung Leuser, see Borner (1979) and Kurr (1970).

Soon after the party was dropped by helicopter on the first expedition, in a small natural opening in the forest cover halfway along the upper Mamas river, fresh human tracks were found. The next day a camp site was discovered, where later camp Pawang was constructed, and on July 17, 1975, a series of rhino traps was found on a ridge west of this camp site.

The traps, of the spear-fall type, were built over a rhino trail on a ridge. Seven traps were made on a line over about 1.5 km, each 50 to 400 metres apart. At the time of the find six spears had already dropped, and only one trap was still intact. Four had missed and the spear was stuck in the ground, but from two traps the spear was missing, which means that a rhino may have been hit. Probably one rhino ran into two traps, but no dead animal could be found. The spear does not kill the animal immediately, but it will die within a few kilometres from the place where it was hit. No time was available to make a search for the corpse, which can take several days. It is said that rhino hunters only recover about half of the animals that are wounded.

Figure C.1 shows the construction of the trap. The whole construction is hung from a horizontal pole, tied with rattan between two trees at the sides of the game trail, some 8 to 10 metres above the ground. A small pole, with a few cross-bars, are tied to the stems of these trees, to facilitate the construction of the trap. The main part of the trap, the weight, is cut from a straight trunk, some 15 cm in diameter and 230 to 300 centimetres long. On one end a hole is made for the hanging cord, on the other end a notch is made to attach the spear.

The spear is almost one metre long and made from a hard type of wood (sometimes bamboo is used). The spear is pointed very sharp and smooth. It is tied with a few thin strips of rattan to the notch on the weight, precisely in the centre of the log. The hanging cord is made of a few twined rattans, about 40 cm long, with a 25 cm long wooden peg on the end. The end of the cord is hung over the horizontal beam, with the peg pointing downwards. Peg and cord are held together by a rattan ring, connected to the trigger thread.

The trigger thread, a long thin rattan, is stretched over the game trail, about 30 cm above the ground. It is attached to two sticks left and right of the game trail. The trigger thread is guided upward through rattan rings. When an animal disturbs the trigger thread the ring is pulled from the peg on the hanging cord and the whole construction drops down, driving the spear into the rhino's back.

On the second expedition another series of traps, made by the same group of poachers, was found on a ridge west of the Mamas river. At this place there were 9 traps, all already out of order. The poachers were soon known to the park management and together with the local police they managed to apprehend one of them red-handed, carrying 26 kilograms of rhino bones out of the reserve. A member of the park management had posed as trader in rhino products and persuaded the man to go into the reserve and collect bones of the rhinos that had been killed previously. The leader of the group, a pawang from kampong Porang near Blangkejeren, was not caught but he died shortly afterwards while hiding in a remote village. The captured poacher was prosecuted and jailed for about 7 months.

He informed the park management that the first traps in the Mamas were built in July 1974 and another series was made in April 1975. It is not completely clear how many rhinos were killed during this period, but horns from at least three rhinos were sold to Chinese in

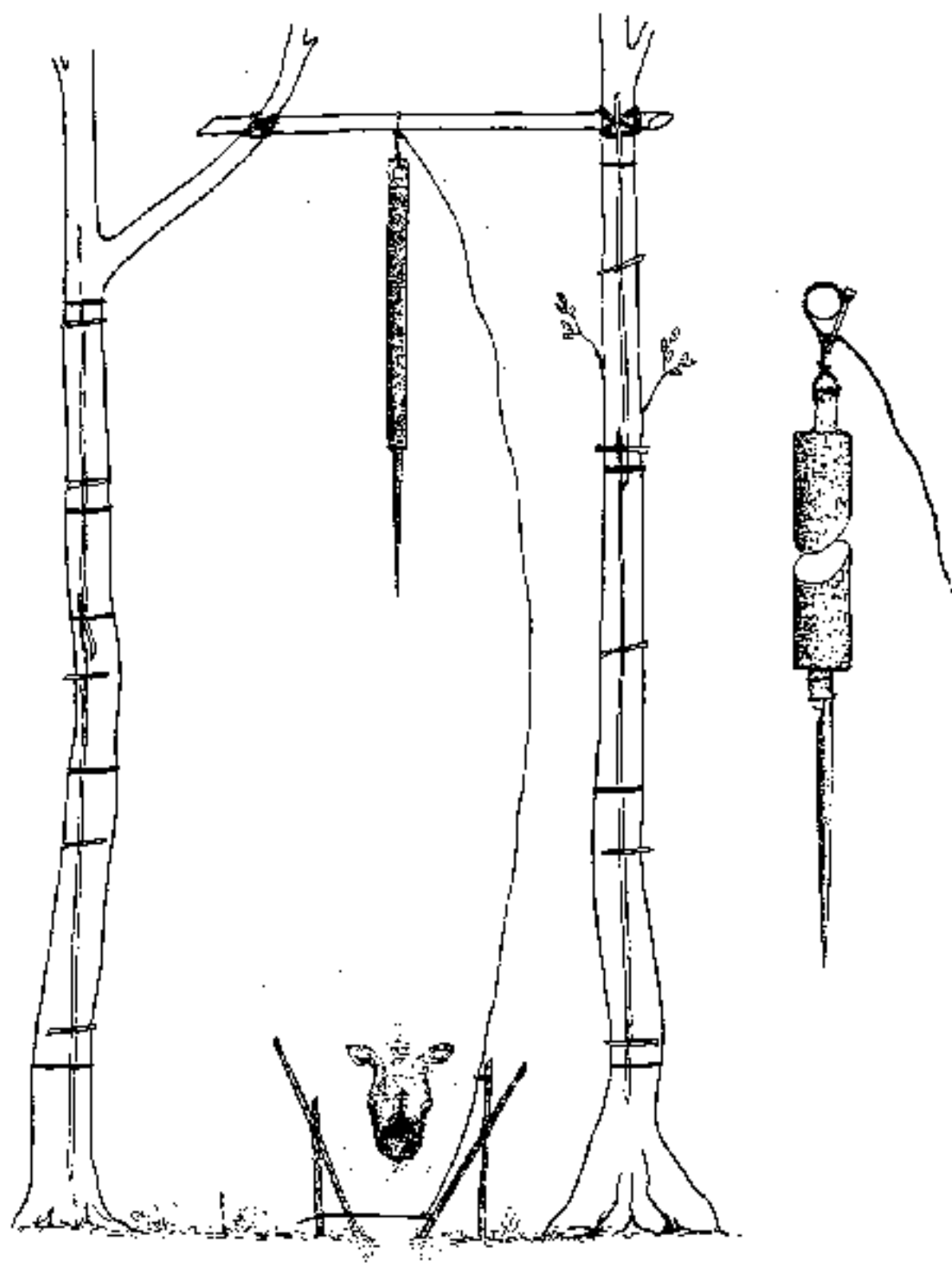

Figure C.) - The construction of the spear traps used in the Gunung Leuser area

Medan. The poacher probably did not reveal everything he knew and it appeared that at least 4 and probably up to 6 rhinos were killed in the Mamas between July 1974 and July 1975. From the killed rhinos the horns and hoofs were sold (for about 40 000 Rp (US\$ 90.-) per 100 grams or more. The teeth were also taken and given to relatives and local officials. The corpses were buried and the poacher was caught with one of these skeletons.

The poacher's success clearly demonstrates the efficiency of these type of traps. When 4 to 6 rhinos can be caught by just one group of hunters in one year, it is not difficult to imagine what will happen if these activities continue in the upper Mamas. If poaching continues within a few years there will be no rhino left in the Mamas and rhinos will disappear completely from Gunung Leuser.

In March 1976 more evidence of rhino poachers was discovered in the Mamas. This time the people had entered from the Kompas river area, the best known entrance route. They had placed snares, anchored to a piece of log, in the deep trails leading to the important saltlicks at Sungai Pinuz. They also used an old treehide as a shooting-platform. From the platform they had stretched a signal thread to the saltlick and apparently also had a strong searchlight.

The snares were made from thin wire cable, with a loop of about 60 cm diameter, and were tied to a pole about 150 cm long, anchored behind a few small trees. The snares were positioned in the very deep and narrow trails to the saltlick, held in position with a few pegs in the sides of the trail. Apparently no rhino was shot or trapped in the snares and all snares were destroyed. The poachers were never caught and there is a strong suspicion that someone from the local police or army was involved.

After that no more attempts were made to trap rhino in the Mamas during the course of the study. It was widely known that the area was under regular surveillance and that there was a certain risk of being caught. Later some pitfalls were discovered in the Kompas area, south of the Mamas, by a patrol of park guards. This is an unusual method of trapping rhino in north Sumatra and probably outsiders were involved. At that time a pair of rhinos originating from Sumatra was offered by an animal dealer in Singapore and there could very well be a connection.

During the fieldwork it became clear that the interior of the reserve is far from being completely unvisited. At various places, all over the Mamas, marks were found on tree trunks, that were clearly much older than those left by the 1973 geological survey, and it was clear that small groups of people had been over most of the area. Since no more rhino traps were found people probably visited the area for other reasons than rhino hunting. During the study several groups of men entered the Mamas, but usually they were connected with one of the numerous mineral surveys, of which the park staff were never informed.

ACKNOWLEDGEMENTS

This study would not have been possible without the assistance of a great number of people and organizations. There is only space here to mention a few of the people who generously supported this study, but I wish to express my sincere thanks to everyone who helped to make my stay and work in Indonesia and the production of this paper into a success.

The study was initiated by Prof. Dr. M.F. Mörzer Bruyns, who supervised the execution of the fieldwork. I am greatly indebted for his never-ending enthusiasm and perseverance, without which this study would probably never have taken place. After his retirement the supervision was taken over by Prof. Dr. C.W. Stortenbeker, whose careful and critical reading of the draft greatly contributed to the final shaping of this paper. I am also thankful to the Nature Conservation Department, Agricultural University, Wageningen for their support of this study, especially during the period in which I was allowed to make and publish a study of literature on the Sumatran rhino. Especially Dr. W. Bongers has been very helpful.

I want to express my special appreciation for those organizations in Indonesia who gave their kind permission and support for this study. I am thankful to the Indonesian Institute of Science (LIPI) for their permission to carry out research in Indonesia and to the Directorate of Nature Conservation (PPA) for their permission to carry out the programme in Gunung Leuser National Park. I am greatly indebted to the staffs of the PPA offices in Medan and Kutacane for their support in the field and in matters of administration and organization. From the numerous officials who helped me in any way, I would like to mention specially Mr. Matingan Arisonang and Mr. R.Y. Bangun Mulya.

The study was financed by grants and donations from a great number of sources. The largest part of the cost was carried by the Netherlands Foundation for the Advancement of Tropical Research (WOTRO). I am thankful for their confidence in the project. The World Wildlife Fund has contributed considerably to the success of the project by their supply of housing, transport and grants for activities related to conservation in Gunung Leuser. I am much obliged for their permission to continue the study while being contracted to draft a management plan for the Gunung Leuser National Park. I am specially thankful to the late Dr. J.H. Westermann for his encouragement during the first years of the study. Further donations were received from: Spaarbank voor de Stad Amsterdam, Deli-Maatschappij N.V., H.V.A.-Maatschappijen N.V., Shell Nederland B.V., Beijerinck-Popping Foods, Van Tienhoven Stichting, Maatschappij voor Wetenschappelijk Onderzoek in de Tropen. Personal contributions to the project were received from 29 members of Wereld Natuurfonds Nederland. All these donations together formed a substantial startingfund, which stimulated the acceptance of the project in other organizations. My warmest gratitude is expressed to these initial donors for their confidence.

I am grateful to the Directorate General of International Cooperation (DGIS) of the Netherlands Government for their generosity to give me a four months' leave for the final drafting of this thesis. I want to thank my former colleagues at the School of Environmental Conservation Management in Bogor for their comradeship and sympathy during the years I was working out the results in the after hours.

My warmest and most sincere gratitude is expressed to the local field-assistants, who accompanied me on the expeditions to the study area. Their diligence and cheerfulness, even under the most arduous and depressing conditions, was inspiring and without their perseverance and courage the expeditions would not have been possible. Many persons have contributed to the success of the expeditions, and I can only mention those who took part most often. The services of Bpk. M. Jusa, whose sense of responsibility was paramount for the success of the first expeditions, and who also restored and mounted the plastercasts with meticulous precision, are acknowledged. Also the brothers Rahman and Sallim, who took part in most of the expeditions, and Sean and Pawang Husin contributed anonymously to the success of many expeditions.

Special thanks are expressed to Dr. Willem J.J.O. de Wilde and Dr. Brigitta E.E. de Wilde-Duyfjes, for their advice and encouragement during the first months of the study. What I could learn from their experience was of great value for the initial phases of the development of the study area. They also took care of the identification of the collected plants.

I am very grateful to the Medan offices of Indonesia Air Transport, Mobil Oil and Asameta Oil, who helped me in obtaining helicopter transport, often at very favourable rates. I appreciated their willingness to help me and to risk their valuable craft for unscheduled flights into treacherous mountain area and I admire the courage of the pilots, who always succeeded in bringing us safely to the study area.

I am very thankful to Dr. Kathy MacKinnon for her meticulous corrections of the English text and for her constructive comments, which greatly improved the clarity and consistency of this paper. I thank Mr. K.S. Departi for the translation of the abstract in Indonesian.

Finally I want to thank my wife Tineke for her support and patience. She was a most valuable companion on all the expeditions and had to endure many lonely hours in the later stage of this study. Her involvement in every phase of this study has been of great importance for its completion.

REFERENCES

- Andau, P.M. & J. Payne, 1982. The plight of the Sumatran rhinoceros in Sabah, Presented at the 8th Malaysia forestry conference. Sandakan-Sabah, 1982: 13+2 maps.
- Andrewartha, H.G., 1971. Introduction to the study of animal populations. Second edition. University of Chicago Press: XiV+283.
- Bartlett, A.D., 1873. On the birth of a Sumatran rhinoceros. Proceedings of the zoological society of London, 1873: 104-106.
- Beek, C.G.G. van, 1982. Een geomorphologisch bodemkundige studie van het Gunung Leuser nationale park noord Sumatra, Indonesia. Ph. D. thesis, Utrecht: 188+XIV.
- Beddard, P.E. & P. Treves, 1889. On the anatomy of *Rhinoceros sumatrensis*. Proceedings of the zoological society of London, 1889: 7-25.
- Blower, J.H., N. Wirawan & R. Watling, 1981. Preliminary survey of S. Kayan - S. Mentarang nature reserve in East Kalimantan. World Wildlife Fund, Indonesia programme, Bogor.
- Blouch, R.A., 1984. Current status of the Sumatran rhino and other large mammals in southern Sumatra. IUCN/WWF report no. 4. Project 8083 field report, Bogor: 1-39.
- Borner, M., 1973. Progress report no. 1 of February 7th, 1973. WWF - project 884: Sumatran rhino: 9.
- , 1973. Progress report no. 2: Province Aceh. August 20, 1973. WWF project 884 - Sumatran rhinoceros: 16+6 fig.
- , 1974. Progress report no. 3. 13th January 1974. The Sumatran rhinoceros (*Dicerorhinus sumatrensis*) in the provinces of North Sumatra and eastern Aceh. WWF project 884 - Sumatran rhinoceros: 1-13+4 fig.
- , 1974. Progress report no 4. End of May 74. Concerning: The Sumatran rhinoceros (*Dicerorhinus sumatrensis*) in the provinces of Riau and West Sumatra. New rhino traps in the Gunung Leuser reserve. The elephant of Langkat. WWF project 884 - Sumatran rhinoceros: II+11+4 fig.
- , 1974. Progress report no 5. December 74. Concerning: The Sumatran rhinoceros (*Dicerorhinus sumatrensis*) in the provinces of Jambi, Bengkulu and Sumatera Selatan (South Sumatra). WWF project 884 - Sumatran rhinoceros: 1-9+4 fig.
- , 1975. Progress report no 6. July 75. Concerning: The Sumatran rhinoceros (*Dicerorhinus sumatrensis*) in the province of Lampung. WWF project 884 - Sumatran rhinoceros: 1-6+4 fig.
- , 1979. A field study of the Sumatran rhinoceros *Dicerorhinus sumatrensis* Fischer 1814. Ecology and behaviour conservation situation in Sumatra. Zurich, Juris: 169+8 plates+II.
- Emery, L., J. Miller & N. Van Hoosen, 1977. Horsehoofing theory and hoof care. Lea & Febiger, Philadelphia: XIV+271.
- Evans, G.H., 1905. Notes on rhinoceros in Burma, *R. sondaicus* and *sumatrensis*. Journal of the Bombay natural history society 16(4): 555-561.
- Frankel, O.H. & M.E. Soule, 1981. Conservation and evolution. Cambridge university press, Cambridge: VIII+327.
- Flynn, R.W., 1978. The Sumatran rhinoceros in the Endau-Rompin National Park of peninsular Malaysia. Malayan naturalist 4(2): 5-12.
- , 1980. Food habits of the Sumatran rhinoceros in the Endau-Rompin area in Malaysia. Preliminary report, IUCN/WWF project 1649 and Malaysia department of wildlife and national parks: 14.
- , 1981. Distribution, ecology & conservation of the Sumatran rhinoceros in Malaysia. Progress report, July 1981: II+33.
- & M.T. Abdullah, 1983. Distribution and number of Sumatran rhinoceros in the Endau-Rompin region of peninsular Malaysia. Malayan nature journal 36: 219-247.
- & --, 1984. Distribution and status of the Sumatran rhinoceros in peninsular Malaysia. Biological conservation 26: 253-273.
- Garrod, A.H., 1873. On the visceral anatomy of the Sumatran rhinoceros (*Ceratorhinus sumatrensis*). Proceedings of the zoological society of London, 1873: 92-104.
- Grasse, P-P., 1955. Traite de Zoologie: anatomie, systematique, biologie, XVII: Mammiferes, les ordres anatomie, ethologie, systematique (Premier fascicule). Masson & Cie., Paris: VIII+1170.

- Groves, C.P., 1963. Description of a new subspecies of rhinoceros from Borneo, *Dicerorhinus sumatrensis harrissoni*. *Saugerierkundliche mitteilungen* 13(3): 128-131.
- Helmkaupf, K.E. & F. Nagashima, 1973. Final report on general survey Sumatra block 3, PT Atjeh Minerals Indonesia: X+63+XXX.
- Hoogerwerf, A., 1939. Bergen, bosschen and blangs in de Gajo- en Alaslanden. Een tocht door de Gajo- en Alaslanden en iets over het I.Aster-reservaat. In: 3 jaren Indisch natuurleven. Nederlandsch-Indische vereeniging tot natuurbescherming, Verslag 11: 243-288.
- Hubback, T.R., 1939. The two-horned Asiatic rhinoceros (*Dicerorhinus sumatrensis*). *Journal of the Bombay natural history society* 40(4): 549-617.
also: *Journal of mammalogy* 20(1): 1-20.
- Institute of meteorology and geophysics, 1960. Meteorological note 8(II), 1931-1960. Department of communications Indonesia.
- Jonge, H. de, 1964. Inleiding tot de medische statistiek. Deel II. verhandelingen van het Nederlands Instituut voor praeventieve geneeskunde 48: XIV, 432-832.
- Khairiah Mohd Shariff, 1983. Status and distribution of Sumatran rhinoceros (*Dicerorhinus sumatrensis*) in peninsular Malaysia. *The journal of wildlife and parks*, Kuala Lumpur, 2: 91-102.
- Kreulen, D.A. & T. Jager, 1984. The significance of soil ingestion in the utilization of arid rangelands by large herbivores, with special reference to natural licks on the Kalahari pans. In: Gilchrist & Mackil. *Herbivore nutrition in the subtropics and tropics*. The science press: 204-221.
- Kurt, P., 1970. Final report to IUCN/SSC and WWF International of project 396: Leuser reserve (Sumatra): VI+139.
- , 1973. Der Gunung Leuser survey 1970. *Zeitschrift des Kölner zoo* 16(2): 59-74.
- Lauris, W.A., 1978. The ecology and behaviour of the greater one-horned rhinoceros. Ph. D. thesis Cambridge: III+XXVI+450+32 plates.
- Lavieren, L.P. van, 1982. Wildlife management in the tropics with special emphasis on South East Asia. A guidebook to the warden. Part 1, Introduction, taking fieldnotes & wildlife census methods. Bogor: IV+146.
- McDougal, C., 1977. The face of the tiger. Rivington books, Andre Deutsch: 180.
- McNeely J.A. & A. Lauris, 1977. Rhinos in Thailand. *Oryx* 13(5): 486-489.
- Maynard, L.A., J.K. Loosli, H.P. Hintz, R.G. Warner, 1979. Animal nutrition. Seventh edition. Tata McGraw-Hill, New Delhi: X+602.
- Miller, C.S., 1942. Zoological results of the George Vanderbilt Sumatran expedition, 1936-1939, part V. Mammals collected by Frederic A. Usher Jr. on Sumatra and Nias. *Proceedings of the academy of natural sciences of Philadelphia* 94: 107-165.
- Milton, O., 1964. The orang-utan and rhinoceros in north Sumatra. *Oryx* 7(4): 177-148.
- Moen, A.W., 1973. Wildlife ecology, an analytical approach. Freeman and Co., San Francisco: XX+458.
- Mohd Zuber bin Mohd Zain, 1983. A review of the status and approximate range of Sumatran rhino population in Sg. Dusun game reserve and surrounding areas. *The journal of wildlife and parks*, Kuala Lumpur, 2: 1-35.
- National research council, 1978. Nutrient requirements of horses. 4th revised edition. Nutrient requirements of domestic animals. National academy of sciences, Washington: VI+33.
- Penwar, H.S., 1979. A note on tiger census technique based on pugmark tracings. *Tigerpaper* 6(2/3): 16-16.
- Rookmaaker, L.C., 1977. The distribution and status of the rhinoceros, *Dicerorhinus sumatrensis*, in Borneo - a review. *Bijdragen tot de dierkunde* 47(2): 197-204.
- , 1980. The distribution of the rhinoceros in eastern India, Bangladesh, China, and the Indo-Chinese region. *Zoologische anzeiger* 205(3/4): 253-268.
- Schenkel, R. & L. Schenkel-Hulliger, 1969. The Javan rhinoceros (*Rh. sondaicus* Desm.) in Ujung Kulon nature reserve: its ecology and behaviour. *Fieldstudy 1967 and 1968*. *Acta tropica* 26(2): 97-135.
- & --, 1969. Report on a survey trip to Riau area and the Mt. Leuser reserve to check the situation of the Sumatran rhino and the orang utan. Report to WWF, Morges: 7.
- Schneider, G., 1905. Ergebnisse zoologischer Forschungstouren in Sumatra, erster Teil: Saugtiere (Mammalia). *Zoologische Jahrbucher, Abt. Systematik, Geographie und Biologie*, 23: 1-172.

- Seidensticker, J., 1977. Project 1023- "operation tiger". Indonesia, establishment of a reserve in central Sumatra. Report to WWF, Morges.
- Shortridge, G.C., 1915. The Asiatic two horned rhinoceros (*Rhinoceros sumatrensis*, Cuv.). *Journal of the Bombay natural history society* 23(4): 722-744.
- Silvius, M.J., H.W. Simons & W.J.M. Verbeugt, 1984. Soil, vegetation and nature conservation, Berbak game reserve, Indonesia. RJN report / report nr. 758 of the nature conservation department of the agricultural university Wageningen.
- Strickland, D.L., 1967. Ecology of the rhinoceros in Malaya. *Malayan nature journal* 20(1/2): 1-17.
- Strien, N.J. van, 1974. *Dicerorhinus sumatrensis* (Fischer): the Sumatran or two-horned Asiatic rhinoceros - a study of literature. *Mededelingen Landbouwhogeschool Wageningen*, 74(16): 82.
Also: *Mededelingen Nederlandsche commissie voor internationale natuurbescherming* 22 (1975).
- , 1975. Preliminary research february - May 1975. IUCN/WWF project 884/1972. Sumatran rhinoceros international conservation programme. Progress report 1: 7+3 maps.
- , 1975. June - August 1975. IUCN/WWF project 884/1972. Sumatran rhinoceros international conservation programme. Progress report 2: 11+3.
- , 1975. Rhino-traps in the Gunung Leuser reserve. August 1975. IUCN/WWF project 884/1972. Sumatran rhinoceros international conservation programme. Special report 1: 11+2.
- , 1976. Second and third Mamas expedition. IUCN/WWF project 884/1972. Sumatran rhinoceros international conservation programme. Progress report 3: 11+2+1 map.
- , 1976. Fourth, fifth and sixth Mamas expedition. January - July 1976. IUCN/WWF project 884/1972. Sumatran rhinoceros international conservation programme. Progress report 4: 6.
- , 1976. Rhino-poaching in the Gunung Leuser reserve. September 1976. IUCN/WWF project 884/1972. Sumatran rhinoceros international conservation programme. Special report 2: 11+4.
- , 1976. Seventh Mamas expedition. August - December 1976. IUCN/WWF project 884/1972. Sumatran rhinoceros international conservation programme. Progress report 5: 1+3.
- , 1977. Eight and ninth Mamas expedition. With an appendix on the logistics of jungle expeditions. January - April 1977. IUCN/WWF project 884/1972. Sumatran rhinoceros international conservation programme. Progress report 6: 1+2+9.
- , 1977. Final report on the 1977 fieldwork. Tenth Mamas expedition. May - November 1977. IUCN/WWF project 884/1972. Sumatran rhinoceros international conservation programme. Progress report 7: 1+5.
- , 1978. Annual report 1978. Eleventh to thirteenth Mamas expedition. IUCN/WWF project 884/1972. Sumatran rhinoceros international conservation programme. Progress report 8: 1+5+2 maps.
- , 1978. Draft management plan for the Gunung Leuser national park. The world wildlife fund Indonesia programme. Bogor: 123.
- , 1980. Report on a survey of the proposed Banumuda extension of Kital, east Kalimantan. Bogor: 4+1 map.
- Suharto Djojosedibarno, 1979. Laporan penelitian habitat sarwa di kabupaten Solok dan kabupaten Pesisir Selatan (komplek G. Kerinci) Sum - Bar. Pusat rehabilitasi mawas Bohorek - Sumatra Utara: 14
- Talbot, L.M., 1960. A look at threatened species: A report on some animals of the Middle East and Southeast Asia which are threatened with extermination. *Oryx* 5(4/5): 153-293.
- Thom, W.S., 1935. Rhinoceros shooting in Burma. *Journal of the Bombay natural history society* 38(1): 137-150.
- U Tun Yin, 1980. Present status of the Asian two-horned rhinoceros in the socialist republic of the union of Burma. *Hornbill*, Bombay, 1980(3): 13.
- Wind, J., 1976. Visit to suaka margasatwa Berbak: 25 Jan - 5 Feb. 1976. FAO/UNDP, Bogor.
- Wroughton, R.C. & W.M. Davidson, 1918. Bombay natural history society's mammal survey of India, Burma and Ceylon: report no. 29, Pegu. *Journal of the Bombay natural history society* 25(3): 472-481.
- Wulf, R. de, 1979? Fieldreport Kerinci-Seblat no. 1. UNDP/FAO national parks development project, Bogor: 23.
- & J.R. MacKinnon, 1980. Field-report Kerinci-Seblat no. 2. UNDP/FAO national parks development project, Bogor: 5.

- , Djoko Supomo & Kurnia Rauf, 1981. Barisan Selatan game reserve management plan 1982-1987. UNDP/FAO national parks development project, Bogor: 1-111+46.
- , -- & --, 1981. Ketinci-Selat proposed national park, preliminary management plan 1982-1987. UNDP/FAO national parks development project, Bogor: 1-111+58+39.
- , 1982. Berbak game reserve, management plan 1982-1987. UNDP/FAO national parks development project. Fieldreport 38, Bogor.
- Zon, A.P.M. van der, 1977. Sumatran rhino in Kalimantan (Borneo). Tigerpaper 4(2): 12.

PLATES

Figure 1 - A young female Sumatran rhino in Melaka Zoo, Malaysia. This animal was caught in 1984 by plantation workers after it had strayed from the Sungai Dusun reserve, north of Kuala Lumpur. The animal is now kept by the Department of Wildlife and National Parks.

Figure 2 - The mountains west of camp Pawang (◆), seen from the eastern ridge. The Mamas flows from left to right at the foot of the mountain and to the right of the mountain the valley of the Sungai Nika is seen. The patrol network extends to the top of this mountain (2124 m).

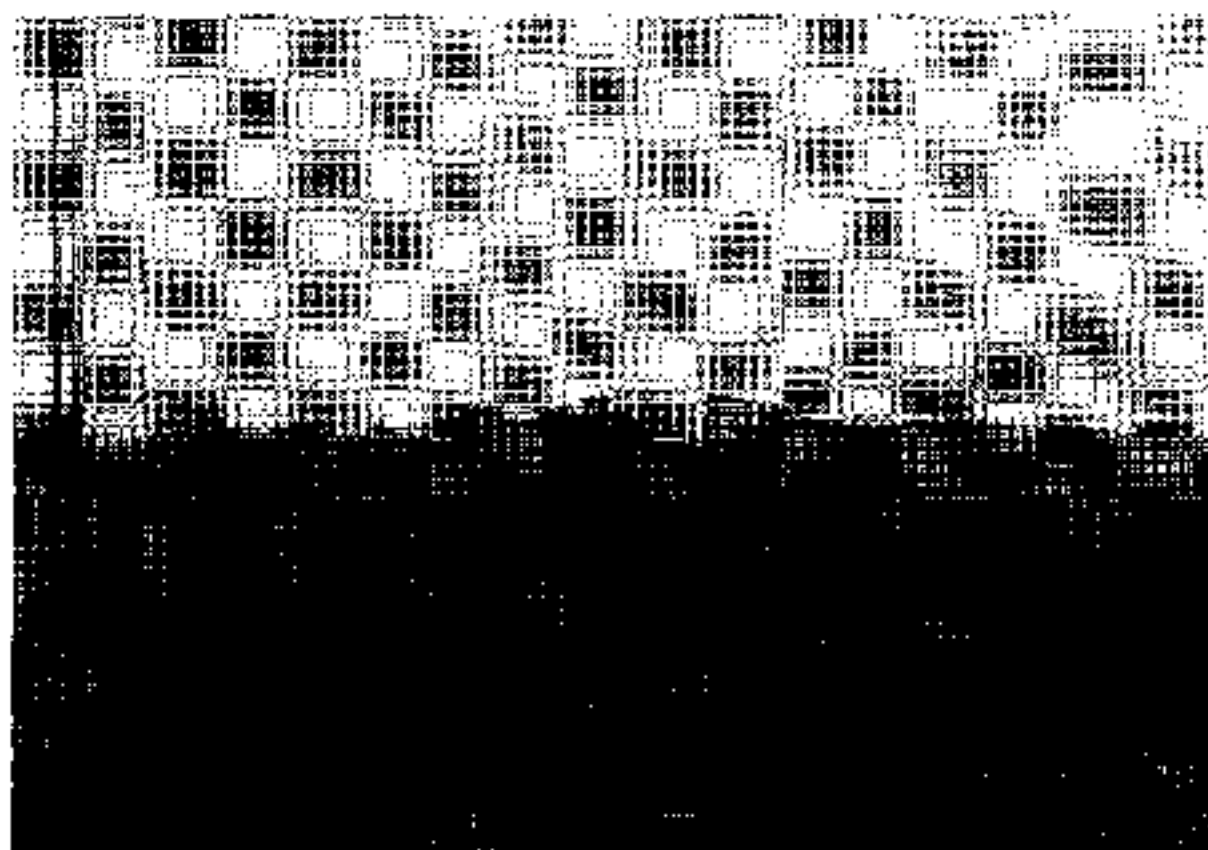

Figure III - The Upper Mamas valley near camp Central (↓) seen from the eastern ridge. The Mamas flows from left to right, approximately in the middle of the photograph. In the right upper corner the valley of the Sungai Badak is seen.

Figure IV - The Upper Mamas valley is relatively flat compared to the rest of Gunung Leuser National Park. Here, the upper reaches of the Sungai Boharak in the Serbalangit range are seen. This type of landscape is typical for most of Gunung Leuser.

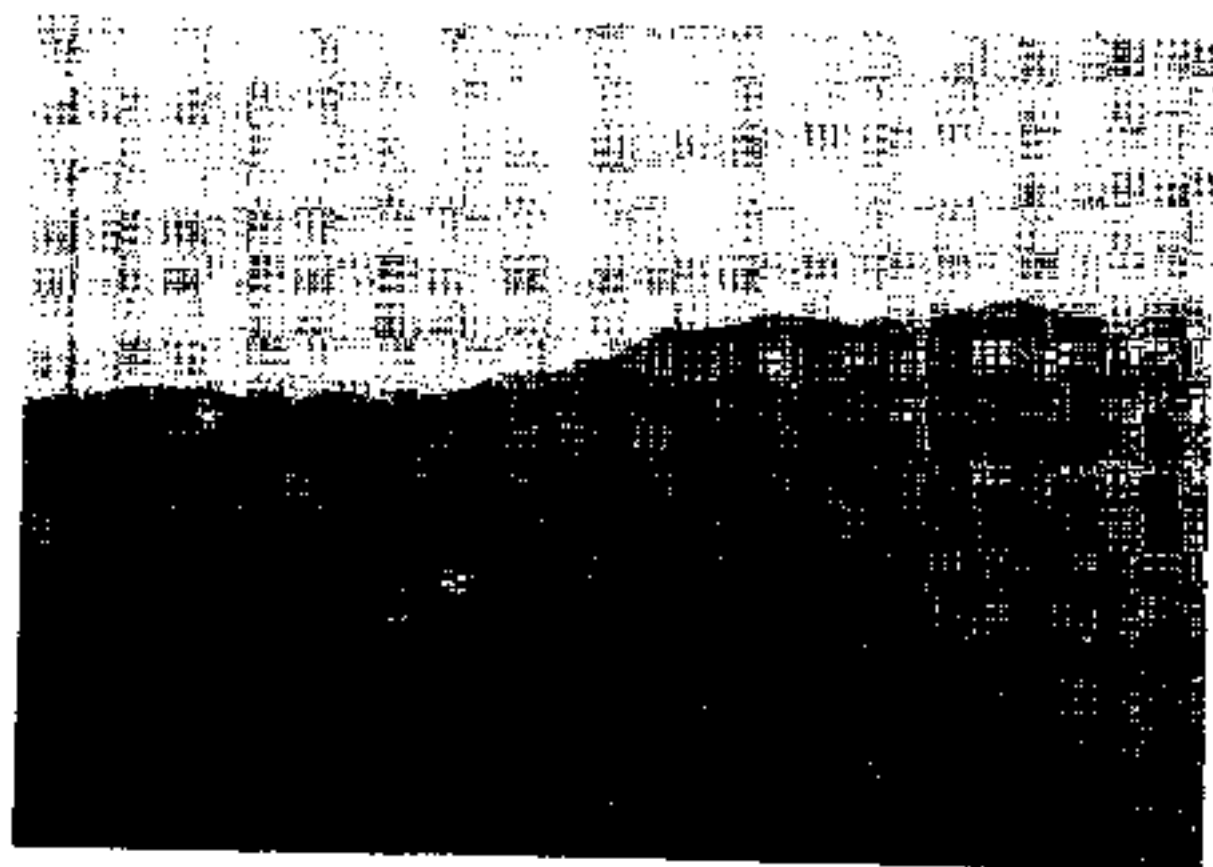
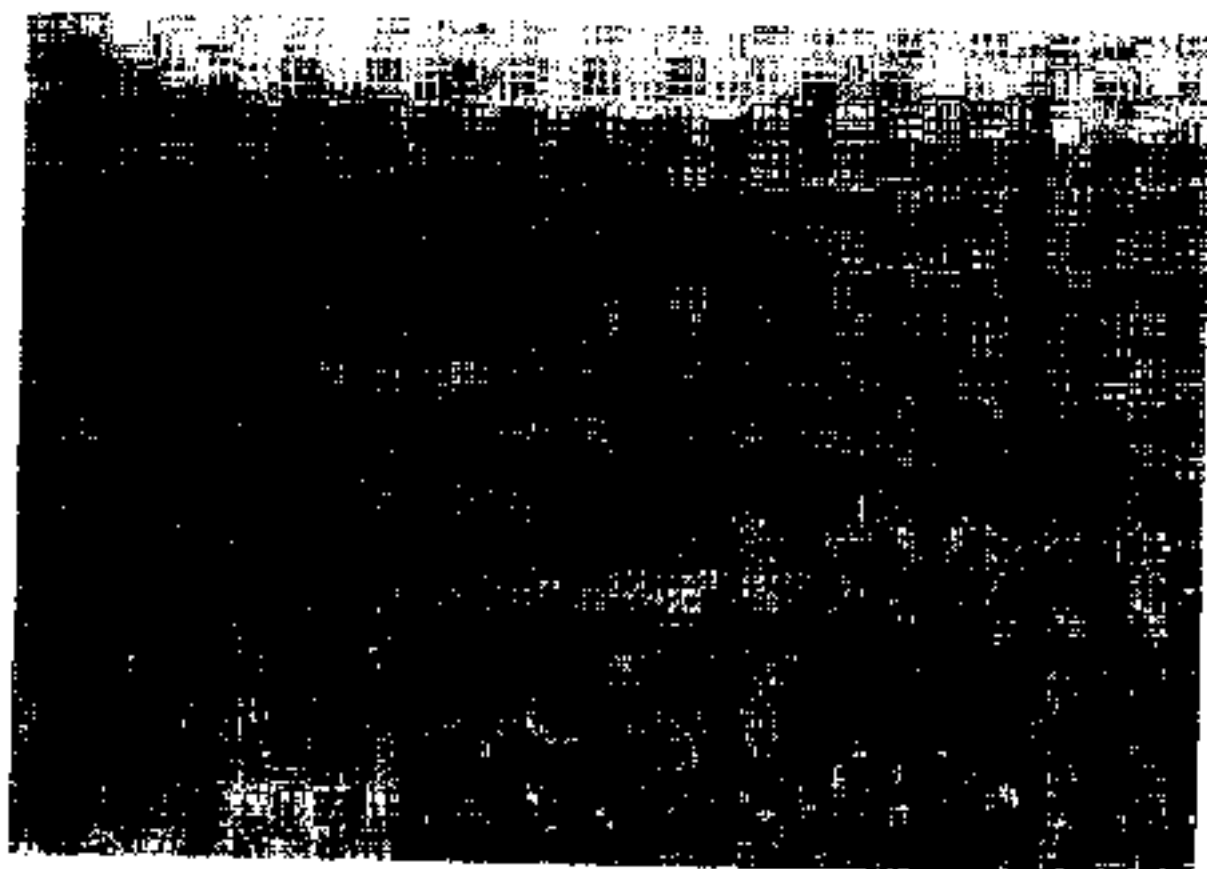

Figure V - Landfalls are common in the steeper parts of Gunung Leuser. The rhinos feed on the young regrowth on places where the canopy has been broken by land- or treefalls.

Figure VI - The Mamas river about halfway between camp Pawang and camp Central. During periods of heavy rainfall the water can rise one and a half metres or more and crossing can be difficult.



Figure VII - Camp Aceh in the northern extension of the study area. The Mamas is fairly wide here and deep and during periods of heavy rainfall this camp could not be reached.

Figure VIII - Camp Pawang. In the centre the kitchen and to the right the raised sleeping platform is seen.

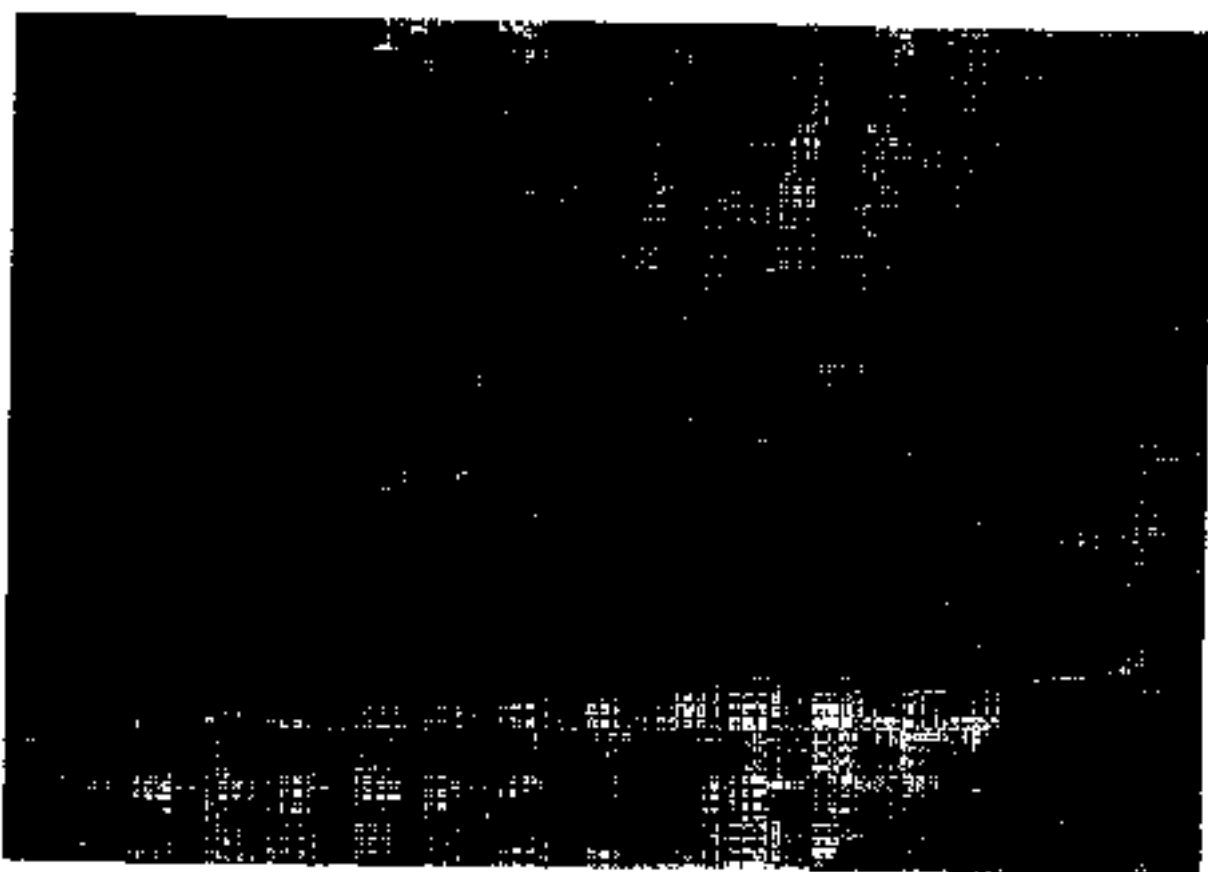

Figure X - Camp Central

Figure IX - A fresh rhino track in a marshy area.



Figure XI - Sub-montane forest at about 1600 metres. There are no very big trees but a great number of saplings and small trees. The people are sitting along a rhino trail.

Figure XII- A rhino trail in the lower parts of the Upper Manias. The forest is very dense here, but the rhino trails are usually wide and open and can easily be followed.



Figure XIII - A rhino trail in low scrub, as is found on the highest ridges in the study area. The rhinos never feed in this scrub and they apparently only use these trails when moving to another side of the mountain.

Figure XIV - A tunnel-like rhino trail in moss-forest. Above about 1800 metres there is mist for most of the days and the soil and tree trunks are thickly covered with moss.

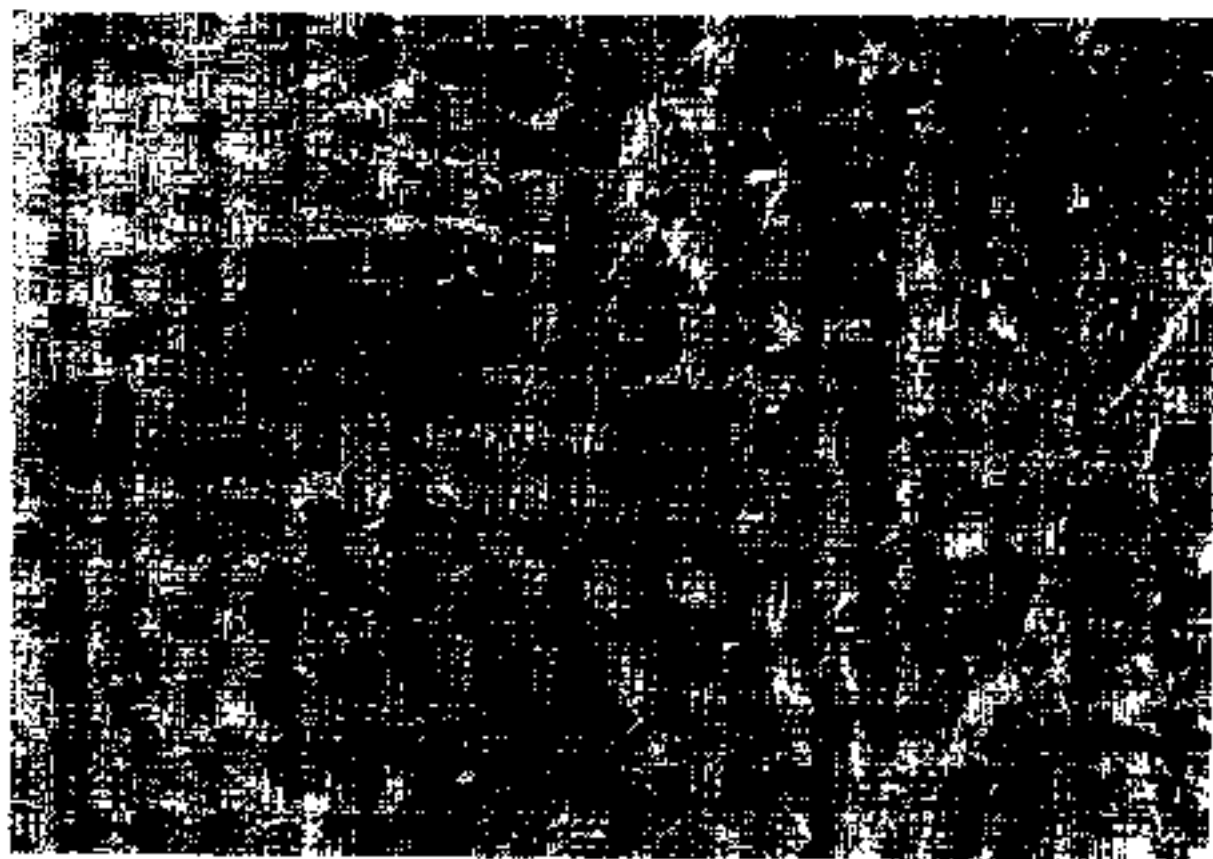
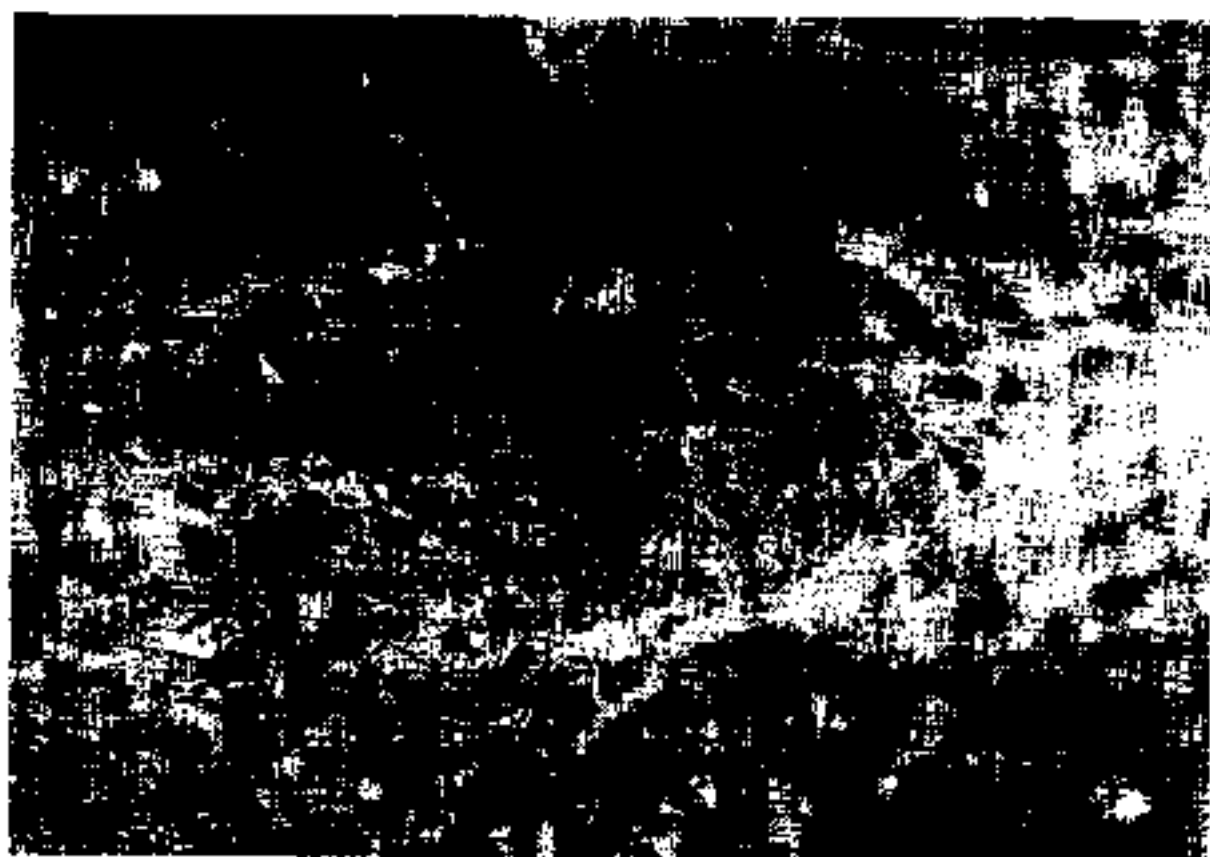

Figure XV - A rhino wallow at the bottom of a slope. With the horn the rhinos dig in the higher soil and a vertical wall is formed.

Figure XVI - Traces of the rhino's horn on the wall of a wallow.

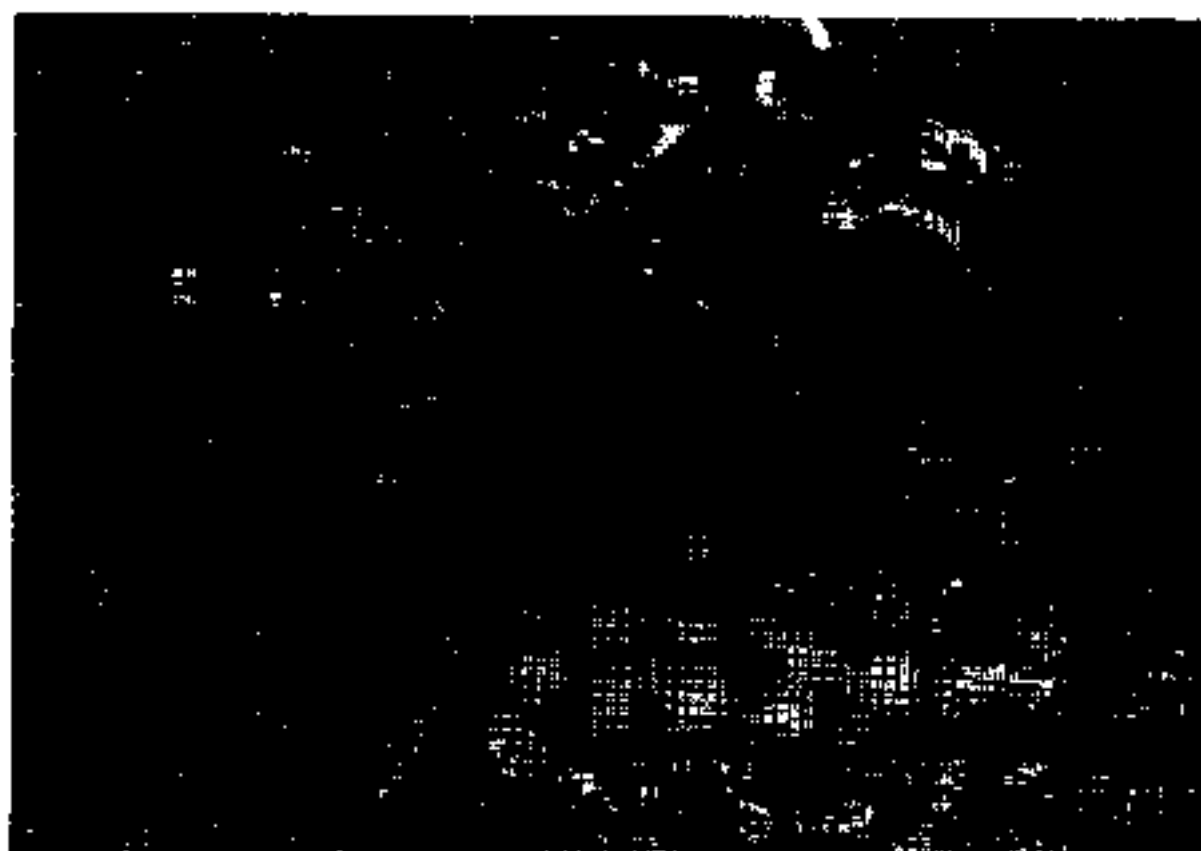

Figure XVII - A sapling broken by a rhino along a trail.

Figure XVIII - A rhino scratch mark along a trail. With the hindfeet the soil, often with feces, is kicked into the vegetation. Broken saplings, scratch marks and urine sprayed over the vegetation are usually only found along the large rhino trails and they obviously function as a visual and olfactory sign of the animal's presence.



Figure XIX - Part of the plastercast collection in the storage boxes.

Figure XX - Part of the reference collection of plastercasts. From each individual rhino the few best casts were placed on racks for easy reference and comparison.

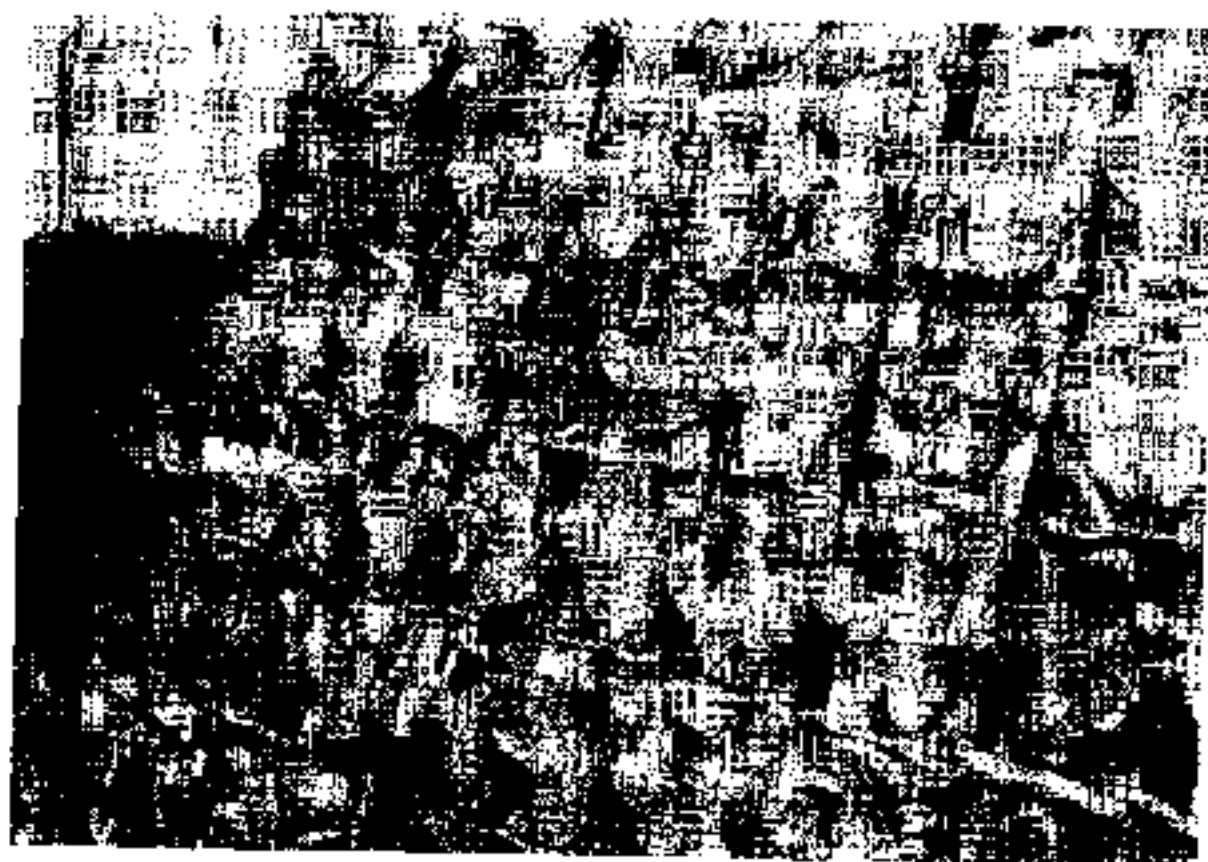

SAMENVATTING

Titel: De Sumatraanse neushoorn - *Dicerorbicus sumatrensis* (Fischer, 1814) - in het Nationale Park Gunung Leuser, Sumatra, Indonesië; Verspreiding, levenswijze en bescherming.

De Sumatraanse neushoorn is een der diersoorten die wel het meest te leiden heeft van de ongebreidelde groei van de wereldbevolking en van de daarmee gepaard gaande vernietiging van de natuurlijke levensgemeenschappen. Daarnaast is de neushoorn van ouds her fel bejaagd voor de waardevolle hoorn. Eens kwam de Sumatraanse neushoorn voor over een groot gedeelte van Zuidoost Azië, van de voet van de Himalaja in Bhutan tot Borneo en Sumatra. Tegenwoordig is de soort uitgeroeid in het grootste deel van dit gebied en nog slechts hier en daar zijn er kleine aantallen te vinden, allen in de meest afgelegen streken.

De Sumatraanse neushoorn is de kleinste van de 5 bestaande neushoorn soorten, en ook de minst bekende. Het dier is al lang zeldzaam en leeft in moeilijk toegankelijk gebied, hetgeen het doen van onderzoek aan deze soort niet eenvoudig maakt. Dit onderzoek werd dan ook niet alleen uit wetenschappelijke belangstelling opgezet, maar ook met het oog op natuurbeschermings aspecten. Door een betere kennis van de verspreiding en levenswijze van de neushoorn kan de bescherming en het beheer van de laatste overgebleven populaties beter worden opgezet en uitgevoerd. Verder is de Sumatraanse neushoorn de grootste planteneter, die uitsluitend in het dichte tropische regenwoud leeft, waardoor de soort een gids-functie vervult bij het instellen van reservaten. Het voorkomen van de Sumatraanse neushoorn geeft aan dat het gebied relatief ongestoord is en een reservaat dat een voldoende grote populatie neushoorns kan herbergen moet ook geschikt worden geacht voor de andere, kleinere, planteneters.

Door de zeldzaamheid en de schuwheid van de neushoorn en door het moeilijke en zeer dicht begroeide terrein is rechtstreekse waarneming van de neushoorn vrijwel uitgesloten. Daarom moest het onderzoek voornamelijk gericht worden op het bestuderen van sporen en andere tekens, welke in het terrein worden aangetroffen. Een van de eerste opgaven bij dit onderzoek was het ontwikkelen van een methode waardoor de afzonderlijke neushoorns aan hun voersporen te herkennen zijn, zodat de bewegingen van de dieren in de ruimte en de tijd kunnen worden gevolgd.

Het onderzoek werd uitgevoerd in het Nationale Park Gunung Leuser, een bijna een miljoen hectare groot reservaat in de bergen van noord Sumatra. Door stoperij is ook hier de stand van de neushoorn sterk aangetast, maar in het moeilijk toegankelijke centrale bergland zouden naar schatting nog enkele tientallen neushoorns voorkomen. Daarom werd daar een studie-gebied gekozen, en wel in het dal van de boven Mamas. Dit is een tamelijk breed hoogland-dal, gelegen op ongeveer 1200 meter boven zeeniveau en omringd door bergen van 1800 tot 2100 meter hoog.

Het hele studie-gebied is begroeid met dicht bos, met uitzondering van een paar kleine moerassige stukjes en van enkele bergtoppen. In het dal liggen een aantal warme bronnen, waar neushoorns en andere dieren het mineraal-houdende water komen drinken. Deze plaatsen worden zoutlikken genoemd. Het gebied wordt doorkruist met wildpaden, langs de grotere rivieren en over de berggruggen. Van deze paden werd ongeveer 150 kilometer in kaart gebracht en als patrouille route gebruikt. Vanuit 6 permanente kampen werd het gehele studie-gebied, dat ongeveer 180 vierkante kilometer beslaat, enkele malen per jaar doorkruist op zoek naar neushoorn sporen.

Voor het bestuderen van de neushoorn sporen werd gebruik gemaakt van gipsafgietsels van de voorafdrukken. In het algemeen werden van ieder spoor twee afgietsels van de linker en twee van de rechter achterpoot gemaakt (de achterpoten worden normaal op de afdruk van de voorpoot gezet). Later werden de afgietsels stuk voor stuk op plankjes gemonteerd. Gedurende de studie werden van 371 verschillende sporen gipsafgietsels gemaakt.

Door vergelijking van de grootte, vorm en stand van de voet en van de drie hoeven, konden een aantal verschillende dieren individueel worden herkend. Bij het vergelijken van de gipsafgietsels werd ook gebruik gemaakt van sterofoam's en van tekeningen van de omtrek van de voet en de hoeven. Verder werden van ieder afgietsel 5 malen genomen.

Hoewel er vele, vaak zeer karakteristieke, verschillen tussen de afgietsels te zien zijn, is het verre van eenvoudig alle afgietsels met zekerheid te identificeren. Vaak zijn de afgietsels van een minder goede kwaliteit en zijn niet alle kenmerken duidelijk te zien, maar ook de grondsoort, de helling en de richting en snelheid van voortbewegen beïnvloeden de vorm van de voetafdruk. Verder bleken er in de loop van de tijd duidelijke veranderingen in de vorm van de hoeven op te kunnen treden.

Nadat de hele collectie afgietsels vele malen was doorgewerkt konden er 39 verschillende neushoorns worden herkend. Acht dieren bleken wijfjes te zijn omdat ze gedurende de studie samen met de sporen van een jong werden gevonden, 4 dieren waren waarschijnlijk mannetjes omdat ze gedurende minstens drie jaren nooit met een jong werden gevonden. Van de ander 9 volwassen dieren kon het geslacht niet met zekerheid worden vastgesteld. Gedurende de studie zijn er 12 jongen geboren en verder werden er nog 5 ander onvolwassen dieren gevonden.

Van een paar jonge neushoorns werden regelmatig sporen gevonden en daaruit kon een groeikurve van de voet worden samengesteld, waardoor het mogelijk is de leeftijd van andere, minder vaak gevonden, jongen te schatten. Er werden geen duidelijke verschillen gevonden tussen de voetafdrukken van mannetjes en die van wijfjes. De voet van een mannetje is waarschijnlijk gemiddeld wat groter en wijfjes lijken vaker een onregelmatige of asymmetrische voet te hebben.

Uit de verspreidingskaarten van de verschillende neusbunten kan de ruimtelijke verdeling van de individuen worden bestraald. Verder kan aan de hand van het aantal verse sporen, in relatie tot de tijd die is verstreken sinds de laatste regenbui, worden berekend hoe vaak een neushoorn een bepaalde plaats bezoekt.

De wijfjes tonen een opvallend verspreidingspatroon. In het studie-gebied bleken de wijfjes neushoorns slechts om de drie of vier jaar een jong te krijgen, dat gedurende anderhalf jaar bij het wijfje blijft. Wijfjes met jongen houden zich op in de omgeving van de zoutlik en trekken rond in een gebied van 10 tot 15 vierkante kilometer. Gemiddeld eens in de drie weken gaan ze naar de zoutlik.

Als het jong zelfstandig wordt blijft het in dit gebied, maar het wijfje trekt zich terug op grotere afstand van de zoutlik. Zonder kalf worden de wijfjes slechts zelden gevonden, meestal in de hoger gelegen gedeeltes aan de rand van het studie-gebied of op weg naar een zoutlik. In deze periode trekken ze waarschijnlijk rond in een relatief klein gebied, 10 vierkante kilometer of minder, en gemiddeld wordt eens per zes weken een bezoek gebracht aan de zoutlik. Het lijkt er op dat de gebieden waar de wijfjes zonder jongen zich ophouden duidelijk van elkaar zijn gescheiden. Daarentegen kunnen er twee of drie wijfjes met een jong zich ophouden in hetzelfde gebied nabij een zoutlik.

Een jonge Sumatranese neushoorn houdt zich aanvankelijk op in een relatief klein gebied, waar het ook met de moeder heeft rondgezworven. Waarschijnlijk trekken jonge neushoorns soms voor enige tijd gezamenlijk op. Geleidelijk worden ook aangrenzende gebieden bezocht en breidt het woongebied zich uit tot 20 of 25 vierkante kilometer. Dan worden deze individuen nog slechts met onregelmatige tussenpozen in het studie-gebied aangetroffen, hergeen er op wijst dat ze waarschijnlijk een zwerfend bestaan leiden en vaak ver van hun oorspronkelijke gebied afwaken.

De woongebieden van de mannetjes neushoorns zijn, net als die van de wijfjes, vrij regelmatig verdeeld over het gebied, maar de individuele woongebieden overlappen elkaar voor een groot gedeelte. Het gebied waarin een mannetje rond trekt is relatief groot, 25 tot 30 vierkante kilometer en soms nog wel meer. Gemiddeld bezoeken mannetjes eens in de twee maanden een zoutlik, maar sommige mannetjes bezoeken deze veel vaker en soms gaan ze ook naar andere zoutlikken.

Volwassen neushoorns worden vrijwel uitsluitend alleen aangetroffen. Slechts in een geval werden er sporen gevonden van twee dieren, een mannetje en een van de jongere dieren, die enige tijd samen optrokken. Dit wijst er op dat de geslachten slechts voor een korte periode samen komen voor de voortplanting.

De dichtheid van de neushoorns in het studie-gebied kon worden berekend aan de hand van het verspreidingspatroon van de individuen. Er blijken ongeveer 13 of 14 dieren per 100 vierkante kilometer voor te komen in de boven Mamas. Gebaseerd op deze cijfers kan de totale populatie van de neushoorn in Gunung Leuser geschat worden op 130 tot 200 dieren.

Alle neushoorns in het studie-gebied bezoeken van tijd tot tijd een van de zoutlikken en drinken van het mineraal-rijke water. Omdat de meeste dieren slechts met tussenpozen van een maand of langer een zoutlik bezoeken, is het waarschijnlijk dat het daarbij niet alleen om de, relatief geringe hoeveelheid, mineralen gaat. Het lijkt er op dat de zoutlikken ook als ontmoetingsplaats functioneren. Sommige mannetjes gaan veel vaker naar een zoutlik en ze zwerfen dan enige tijd rond in de omgeving, hetgeen de indruk wekt dat ze de omgeving afzoeken naar andere sporen, misschien van een wijfje dat daar eerder was.

In de loop der jaren hebben de neushoorns, en de olifanten, een uitvoerig padenstelsel gemaakt over het hele gebied. Vooral langs de grotere rivieren en over de hoogste bergguggen zijn deze paden breed en open en ze vergemakkelijken het zich verplaatsen aanzienlijk, niet alleen voor neushoorns maar ook voor andere dieren en onderzoekers. Neushoorns volgen deze paden soms voor vele kilometers, vooral op weg naar een zoutlik. Verder lopen ze vaak min of meer langs de hogtelijnen over de hellingen en ze lijken zich vooral te oriënteren op de grote rivieren en op de bergguggen.

In het gehele gebied worden modderkuilen of zolen aangetroffen, waarin de neushoorns zich regelmatig baden. Soms is het niet meer dan een oedlepe put in een drassige plaats, maar op andere plaatsen, vooral langs de grote paden, zijn er een aantal kuilen bijeen gemaakt, soms door veelvuldig gebruik diep uitgegraven in de helling. Andere dieren maken ook van deze zolen gebruik, maar de neushoorn geeft er de karakteristieke vorm aan.

Langs de grotere paden maken de neushoorns soms opvallende tekens. Met de achterpoot wordt de grond gekrabbd, en vaak worden er op die plek ook een paar boompjes geknakt en wordt het geheel met faeces overdekt of met urine besproeid. Dergelijke tekens worden door beide geslachten en alle leeftijdsgroepen gemaakt, maar slechts zeer zelden door heel jonge dieren. De wat oudere jongen en sommige mannetjes maken relatief veel tekens, terwijl het knakken van boompjes voornamelijk door mannetjes lijkt te worden gedaan, mogelijk een teken van dominantie in een bepaald gebied. Verder zouden de tekens een territoriale betekenis kunnen hebben, waardoor een regelmatigere verspreiding van de dieren over het gebied wordt verkregen.

In het studia-gebied leven de neushoorns voornamelijk van de bladeren en zachte stengeldelen van kruiden en struiken, maar ook worden kleine hoempjes omver gedrukt om er de bladeren vastaf te eten. Hoewel er een grote hoeveelheid voedsel beschikbaar is (de ondergroei in de gebergbebossen is zeer dicht) is de aangroei zeer traag en ook de voedingwaarde is gering. Dit verklaart waarschijnlijk de betrekkelijk lage dichtheid van de neushoorn en is mogelijk ook de reden voor de langzame voortplanting.

Neushoorn faeces is zeer karakteristiek, met een grote hoeveelheid kort-afgebeten stengeldelen. Vooral op de hogere bergruggen kan faeces een jaar of langer herkenbaar blijven. Er kon worden aangetoond dat de aanwezigheid van oude faeces de neushoorn tot een eigen bijdrage stimuleert en verder wordt er meestal wat faeces in het water gadeponeerd als een neushoorn een beekje of riviertje overstreekt.

In eerdere neushoorn studies werd meestal alleen gebruik gemaakt van de breedte van de voetafdrukken om de verschillende dieren te herkennen en een schatting van het aantal te maken. Door vergelijking met de resultaten van de identificatie met behulp van gipsafgietsels kon worden aangetoond dat met voetspoor-breedte alleen zelden betrouwbare resultaten te verkrijgen zijn. Evenwel door naast meten ook gipsafdrukken van de middelste hoeven te maken kan er wel een goede schatting van het aantal dieren in een gebied worden verkregen in een betrekkelijk korte periode.

De hele wereldpopulatie van Sumatraanse neushoorns telt waarschijnlijk minder dan 1000 stuks en deze zijn verspreid over een groot aantal verschillende gebieden. De meeste gebieden herbergen slechts een gering aantal dieren en de overlevingskansen voor dergelijke kleine geïsoleerde populaties zijn gering. Er zijn echter nog enkele vrij grote populaties, met name op Sumatra in Gunung Leuser en Kerinci-Seblat, maar ook in Malaysia en Sabah. Door een goede bescherming kan het aantal neushoorns daar nog belangrijk toenemen en voor het voortbestaan van de soort zijn dit verreweg de belangrijkste gebieden.

Het is daarom van het grootste belang dat de bescherming van deze gebieden verder te verbeteren en de neushoorn stroperij daar actief te bestrijden. Elders dient bezien te worden of de overgebleven neushoorn populaties nog voldoende levenskansen hebben en of het mogelijk is daar voldoende grote reservaten in te stellen om hen ook op de lange duur levensruimte te geven.

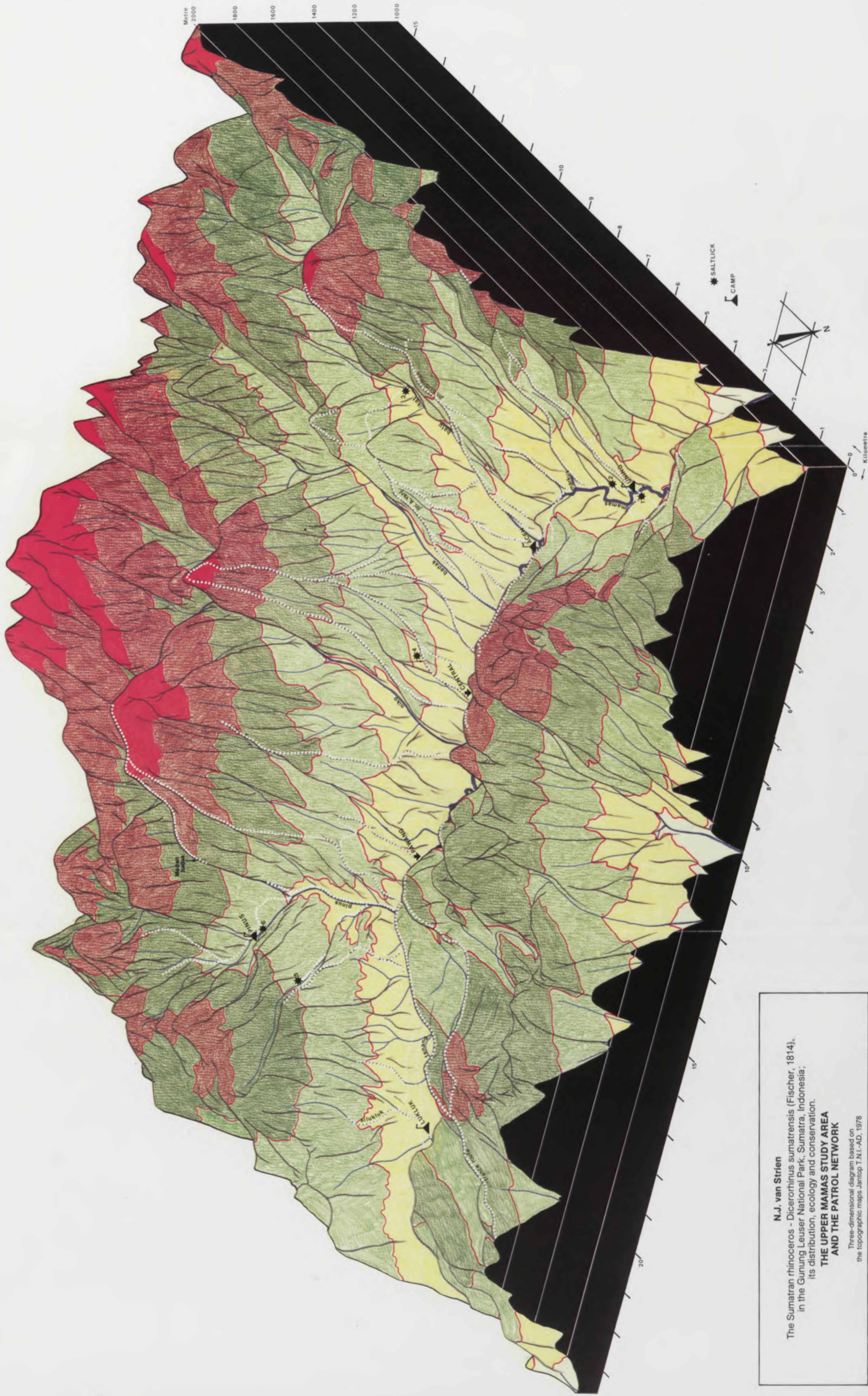

N.J. van Strien
 The Sumatran rhinoceros - *Dicerorhinus sumatrensis* (Fischer, 1814),
 in the Gunung Leuser National Park, Sumatra, Indonesia;
 its distribution, ecology and conservation.
**THE UPPER MAMAS STUDY AREA
 AND THE PATROL NETWORK**

Three-dimensional diagram based on
 the topographic maps Janitop T.N.I.-AD, 1978